

8350A

SWEEP OSCILLATOR

(Including Options 001 and 400)

SERIAL NUMBERS

This manual applies directly to HP Model 8350A Sweep Oscillator having serial number prefix 2024A.

With changes described in Section VII, this manual also applies to instruments with serial numbers prefixed 2007A and 2019A.

For additional information about serial numbers, refer to **INSTRUMENTS COVERED BY MANUAL** in Section I.

© Copyright HEWLETT-PACKARD COMPANY 1980
1400 FOUNTAIN GROVE PARKWAY, SANTA ROSA, CA. 95404 U.S.A.

MANUAL PART NO. 08350-90001
MICROFICHE PART NO. 08350-90002

Printed: JANUARY 1981



CERTIFICATION

Hewlett-Packard Company certifies that this product met its published specifications at the time of shipment from the factory. Hewlett-Packard further certifies that its calibration measurements are traceable to the United States National Bureau of Standards, to the extent allowed by the Bureau's calibration facility, and to the calibration facilities of other International Standards Organization members.

WARRANTY

This Hewlett-Packard instrument product is warranted against defects in material and workmanship for a period of one year from date of shipment. During the warranty period, Hewlett-Packard Company will, at its option, either repair or replace products which prove to be defective.

For warranty service or repair, this product must be returned to a service facility designated by HP. Buyer shall prepay shipping charges to HP and HP shall pay shipping charges to return the product to Buyer. However, Buyer shall pay all shipping charges, duties, and taxes for products returned to HP from another country.

HP warrants that its software and firmware designated by HP for use with an instrument will execute its programming instructions when properly installed on that instrument. HP does not warrant that the operation of the instrument, or software, or firmware will be uninterrupted or error free.

LIMITATION OF WARRANTY

The foregoing warranty shall not apply to defects resulting from improper or inadequate maintenance by Buyer, Buyer-supplied software or interfacing, unauthorized modification or misuse, operation outside of the environmental specifications for the product, or improper site preparation or maintenance.

NO OTHER WARRANTY IS EXPRESSED OR IMPLIED. HP SPECIFICALLY DISCLAIMS THE IMPLIED WARRANTIES OF MERCHANTABILITY AND FITNESS FOR A PARTICULAR PURPOSE.

EXCLUSIVE REMEDIES

THE REMEDIES PROVIDED HEREIN ARE BUYER'S SOLE AND EXCLUSIVE REMEDIES. HP SHALL NOT BE LIABLE FOR ANY DIRECT, INDIRECT, SPECIAL, INCIDENTAL, OR CONSEQUENTIAL DAMAGES, WHETHER BASED ON CONTRACT, TORT, OR ANY OTHER LEGAL THEORY.

ASSISTANCE

Product maintenance agreements and other customer assistance agreements are available for Hewlett-Packard products.

For any assistance, contact your nearest Hewlett-Packard Sales and Service Office. Addresses are provided at the back of this manual.

SAFETY CONSIDERATIONS

GENERAL

This product and related documentation must be reviewed for familiarization with safety markings and instructions before operation. This product has been designed and tested in accordance with international standards.

SAFETY SYMBOLS



Instruction manual symbol: the product will be marked with this symbol when it is necessary for the user to refer to the instruction manual (refer to Table of Contents).



Indicates hazardous voltages.



Indicates earth (ground) terminal.

WARNING

The WARNING sign denotes a hazard. It calls attention to a procedure, practice, or the like, which, if not correctly performed or adhered to, could result in personal injury. Do not proceed beyond a WARNING sign until the indicated conditions are fully understood and met.

CAUTION

The CAUTION sign denotes a hazard. It calls attention to an operating procedure, practice, or the like, which, if not correctly performed or adhered to, could result in damage to or destruction of part or all of the product. Do not proceed beyond a CAUTION sign until the indicated conditions are fully understood and met.

SAFETY EARTH GROUND

This is a Safety Class I product (provided with a protective earthing terminal). An uninterruptible safety earth ground must be provided from the main power source to the product input wiring terminals, power cord, or supplied power cord set. Whenever it is likely that the protection has been impaired, the product must be made inoperative and be secured against any unintended operation.

BEFORE APPLYING POWER

Verify that the product is configured to match the available main power source per the input power configuration instructions provided in this manual.

If this product is to be energized via an autotransformer make sure the common terminal is connected to the neutral (grounded side of mains supply).

SERVICING

WARNING

Any servicing, adjustment, maintenance, or repair of this product must be performed only by qualified personnel.

Adjustments described in this manual may be performed with power supplied to the product while protective covers are removed. Energy available at many points may, if contacted, result in personal injury.

Capacitors inside this product may still be charged even when disconnected from its power source.

To avoid a fire hazard, only fuses with the required current rating and of the specified type (normal blow, time delay, etc.) are to be used for replacement.

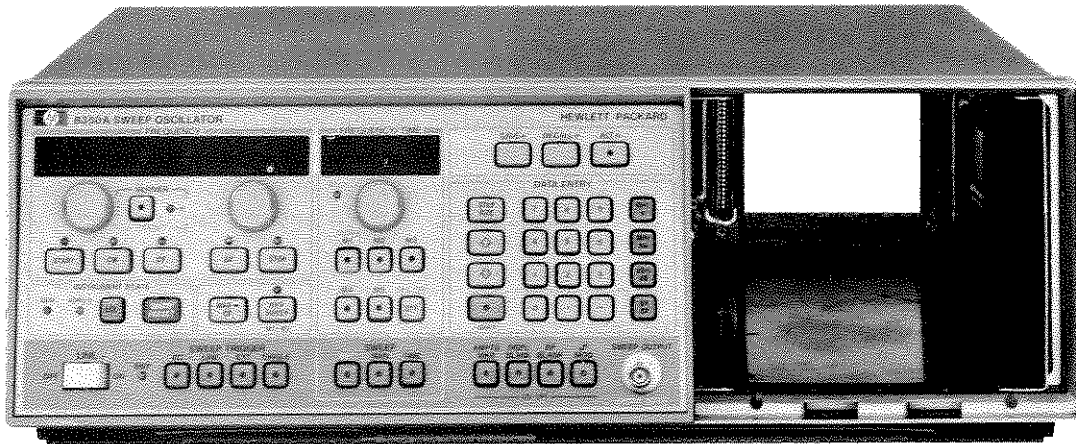

HP 8350A SWEEP OSCILLATOR

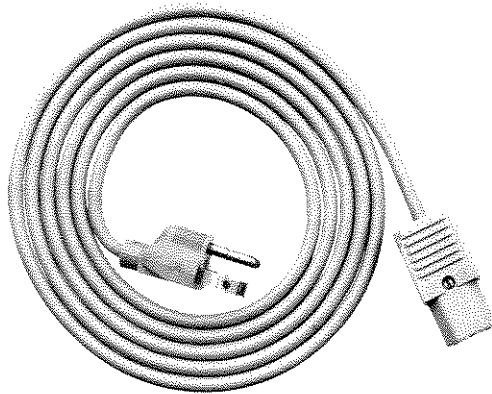

POWER CABLE*

*POWER CABLE/PLUG SUPPLIED DEPENDS ON COUNTRY OF DESTINATION. REFER TO SECTION II FOR PART NUMBER INFORMATION.

Figure 1-1. Model 8350A Sweep Oscillator

SECTION I GENERAL INFORMATION

1-1. INTRODUCTION

1-2. This Operating and Service Manual contains information required to install, operate, test, adjust, and service the Hewlett-Packard Model 8350A Sweep Oscillator. Figure 1-1 shows the Model 8350A and power cable.

1-3. This manual is divided into eight major sections which provide the following information:

- a. SECTION I, GENERAL INFORMATION, includes a brief description of the instrument, safety considerations, specifications, supplemental characteristics, instrument identification, options available, accessories available, and a list of recommended test equipment.
- b. SECTION II, INSTALLATION, provides information for initial inspection, preparation for use, battery information, rack mounting, storage, and shipment.
- c. SECTION III, OPERATION, consists of three subsections which contain general operating information, local operation information (non-HP-IB), and remote operation information (Programming Notes which provide information on HP-IB use of the Model 8350A).
- d. SECTION IV, PERFORMANCE TESTS, presents procedures required to verify that performance of the instrument is in accordance with published specifications. Performance Tests which are general to most RF plug-in units are given in the section. Performance Test limits and other special tests related to specific RF plug-ins are supplied in each RF plug-in Operating and Service Manual. Included is a Local and Remote Operation Verification procedure.
- e. SECTION V, ADJUSTMENTS, presents procedures required to properly adjust and align the Model 8350A Sweep Oscillator mainframe after repair. Refer to the Operating and Service Manual of the specific RF plug-in used for adjustments related to the RF plug-in.
- f. SECTION VI, REPLACEABLE PARTS, provides information required to order all parts and assemblies.
- g. SECTION VII, MANUAL BACKDATING CHANGES, provides backdating information required to make this manual compatible with earlier shipment configurations.
- h. SECTION VIII, SERVICE, provides an overall instrument block diagram with troubleshooting and repair procedures. Each assembly within the instrument is covered on a separate Service Sheet which contains a circuit description, schematic diagram, component location diagram, and troubleshooting information to aid the proper maintenance of the instrument.

1-4. Supplied with this manual is an Operating Information Supplement. This is simply a copy of the first three sections of the manual which should be kept with the instrument for use by the instrument operator.

1-5. On the front cover of this manual is a "Microfiche" part number. This number may be used to order 10- by 15-centimeter (4- by 6-inch) microfilm transparencies of the Manual. Each microfiche contains up to 60 photo duplicates of the manual pages. The microfiche package also includes the latest Manual Changes sheet as well as all pertinent Service Notes.

1-6. Refer any questions regarding this manual, the Manual Changes sheet, or the instrument to the nearest HP Sales/Service Office. Always identify the instrument by model number, complete name, and complete serial number in all correspondence. Refer to the inside rear cover of this manual for a worldwide listing of HP Sales/Service Offices.

Table 1-1. Model 8350A Specifications (1 of 2)

SPECIFICATIONS
8350A SWEEP OSCILLATOR
 (with RF Plug-in installed)

FREQUENCY CONTROL FUNCTIONS

Range: Determined by RF plug-in unit used.

Linearity: Refer to RF plug-in unit specifications.

START/STOP Sweeps: Sweeps up from the START frequency to the STOP frequency.

Range: START and STOP parameters are independent, fully calibrated, and continuously adjustable over the entire frequency range. STOP frequency must be greater than or equal to START frequency.

CF/ Δ F Sweep: Sweeps symmetrically upward in frequency, centered on the CF (Center Frequency) setting.

Δ F: Frequency width of sweep. Continuously adjustable from zero to 100% of frequency range. START/STOP and CF/ Δ F modes can be interchanged without affecting RF output.

Δ F Accuracy: Refer to RF plug-in unit specifications.

CF Accuracy: Refer to RF plug-in unit specifications.

CF Resolution: 0.024% (4096 points across band).

Δ F Resolution: 0.1% of full band (1024 points across band); 0.012% of full band for 1/8 band or less (8192 points across band); 0.0015% of full band for 1/64 band or less (16,384 points across band).

Display Resolution: 5 digits maximum.

CW Operation: Single frequency RF output. When changing between CF/ Δ F and CW mode, the CW frequency and the Center Frequency (CF) are equivalent.

CW Accuracy: Refer to RF plug-in unit specifications.

CW Resolution: Same as CF.

Vernier: Adjusts CW frequency of swept range up to $\pm 0.05\%$ of RF plug-in band being swept. The vernier adds its value to the appropriate frequency parameter and then resets to zero when the adjustment exceeds $\pm 0.05\%$ for continuous adjustment. The " $\neq 0$ " LED is on whenever a vernier adjustment value is present.

Vernier Resolution: 4 ppm (64 points between each CW point; 262,144 points across band).

Offset: Allows the CW frequency or center frequency of swept range to be offset by any amount up to the full range of the RF plug-in. After entering an offset and returning the displays to the previous mode, the " $\neq 0$ " LED will be on indicating that an offset is present; however, the display will remain unchanged.

Resolution: Same as CF.

Accuracy: Refer to RF plug-in unit specifications.

Frequency Markers: Five frequency markers are independently adjustable and fully calibrated over the entire sweep range. Front panel key provides for the selection of either amplitude or intensity markers.

Resolution: 0.4% of selected sweep width (250 points/sweep).

Accuracy: Refer to RF plug-in unit specifications.

Marker Output: Negative rectangular pulse available from the POS Z BLANK connector on the rear panel. Refer to Table 1-2.

Table 1-1. Model 8350A Specifications (2 of 2)

Marker Sweep: RF output is swept between Marker 1 and Marker 2 frequency values. The Marker 1 and Marker 2 frequency values can be entered as permanent sweep values with the SHIFT key. Pressing MKR SWEEP again returns the instrument to the last START/STOP values.

Marker → CF: Marker-to-Center Frequency function causes the CW or Center Frequency (CF) of the sweep output to equal the frequency of the active marker.

SWEEP AND TRIGGER MODES

Internal: Sweep recurs automatically.

Line: Sweep triggered by ac power line frequency.

External Trigger: Sweep is actuated by an external trigger signal applied to pin 9 of the rear panel Programming Connector on the rear panel. Trigger signal must be $> +2$ Vdc, wider than 0.5 μ s, and not greater than 1 MHz in frequency.

Single: Selects mode and triggers/aborts a single sweep.

Sweep Time: Continuously adjustable from 10 ms to 100 seconds. Minimum sweep time may be more than 10 ms depending upon the specific RF plug-in used and the bandwidth swept.

Manual Sweep: Front panel controls (knobs, keyboard, and step keys) provide continuous manual adjustment of frequency between end frequencies set in any of the sweep functions. Resolution is 0.1% of selected sweep width (980 points across sweep).

External Sweep: Sweep is controlled by a zero to +10 volt sweep ramp external signal applied to the front or rear panel SWEEP OUTPUT/SWEEP INPUT connectors. Resulting RF Output frequency accuracy will be a function of input sweep ramp accuracy and linearity.

Sweep Output: Positive-going, direct-coupled sawtooth at front and rear panel SWEEP OUTPUT/SWEEP INPUT connectors, concurrent with

swept RF output. In CW mode, dc output is proportional to the RF plug-in unit full-band frequency. Refer to Table 1-2.

MODULATION CHARACTERISTICS

External AM: Refer to RF plug-in unit specifications. Rear panel BNC connector.

Internal AM: Square wave modulation available at all sweep speeds through front panel control. Refer to RF plug-in for On/Off ratio specifications. Refer to Table 1-2 for frequency characteristics.

External FM: Refer to RF plug-in unit specifications. Rear panel BNC connector.

GENERAL SPECIFICATIONS

Blanking

RF Blanking: When enabled, RF automatically is turned off during retrace and remains off until the start of next sweep.

Display Blanking: POS Z BLANK; direct-coupled, positive rectangular pulse during retrace and bandswitch points of sweep. Negative intensity marker signals are also output through this connector. NEG Z BLANK; direct-coupled, negative rectangular pulse during retrace and bandswitch points of sweep. Both are rear panel BNC outputs. Refer to Table 1-2.

Pen Lift: Output to control the pen lift function of an X-Y recorder. Refer to Table 1-2 for maximum sink current rating.

Counter Trigger (CNTR TRIG): Output for controlling the external trigger input of the HP 5343A Microwave Frequency Counter. Rear panel BNC connector.

Stop Sweep: Input for stopping the progress of a forward sweep. Rear panel BNC connector.

Table 1-2. Model 8350A Supplemental Characteristics (1 of 2)

SUPPLEMENTAL CHARACTERISTICS
8350A SWEEP OSCILLATOR
 (with RF Plug-in installed)

INPUT/OUTPUT SIGNAL CHARACTERISTICS

Frequency Marker Output: Rectangular pulse, typically -5 volts peak, available from the POS Z BLANK connector on the rear panel. Source impedance is approximately 1000 ohms.

External Sweep: Sweep is controlled by an External Sweep Input signal applied to the front or rear panel SWEEP OUTPUT/SWEEP INPUT connectors. The External Sweep Input must be zero volts at start of sweep, increasing linearly to +10 volts at the end of sweep.

Sweep Output: Direct-coupled sawtooth, zero to approximately +10 volts, at front and rear panel SWEEP OUTPUT/SWEEP INPUT connectors concurrent with swept RF output. Zero volts at start of sweep, approximately +10 volts at end of sweep, regardless of sweep width. In CW mode, dc output is proportional to the RF plug-in unit full-band frequency. In SHIFT CW mode, a 0 to +10 volt ramp is output, regardless of CW frequency.

MODULATION CHARACTERISTICS

Internal AM: Square wave modulation available at all sweep speeds. Factory preset to 27.8 kHz although selectable (via internal jumper) to 1000 Hz or 27.8 kHz. Refer to RF plug-in for On/Off ratio specifications.

INSTRUMENT CONTROL

Control Knobs, Step Keys, and Data Entry Keyboard: All instrument parameters, whether time, frequency, or power, may be set in three ways. The control knobs allow for continuous adjustment of any parameter. An exact function value can be entered through the Data Entry Keyboard. For incrementing or decrementing power or frequency values, the Step Keys (Step Up/Step Down) can be used. The step size can be entered by the user or the pre-programmed default values may be used. The SHIFT key is used to effect the function written in blue on the front panel.

INSTRUMENT STATE STORAGE

SAVE n/RECALL n: Up to 9 different front panel settings can be stored in the 8350A via the SAVE n (n=1 through 9) function. Instrument settings are stored in memory locations 1 through 9 and can be recalled randomly or in sequence (1, . . . ,9,1, . . .) with Step Up/Step Down keys or by contact closure to ground of the Step Up Advance (pin 22 on the rear panel Programming Connector).

ALT n: The ALT n function causes the RF output to alternate on successive sweeps between the current front panel setting and the setting stored in memory location n (n=1 through 9).

INSTRUMENT STATE

Instrument Preset: The Instrument Preset (INSTR PRESET) key sets the 8350A into the following predetermined state: the RF output is swept over the full frequency range of the RF plug-in at the specified maximum leveled power level (an RF OFF condition can be selected by a presetable configuration switch located within the RF plug-in), the internal square wave AM is off, and the frequency markers are off. Instrument Preset also causes an internal analog and digital self-test to occur. If certain internal errors or failures are detected during the self-test or during normal operation of the 8350A, they are indicated via error code messages in the form of "Ennn"(where n=0 through 9) read from the left FREQUENCY display.

Local Operation: The Local (LCL) key is used to return the 8350A to local control from the remotely controlled state. The REM LED indicates when the 8350A is being controlled remotely. The ADRS'D LED indicates when data is being transmitted or received over the HP-IB.

Table 1-2. Model 8350A Supplemental Characteristics (2 of 2)

REMOTE PROGRAMMING (HP-IB)

Instrument Control: All front panel controls except the line power switch may be controlled or programmed remotely. The 8350A is fully compatible with the HP-IB. The 8350A has both input and output capability, providing complete control of the instrument state. The HP-IB address can be displayed on the front panel and is selectable by the user from 0 to 30. Refer to Table 2-3 for a listing of HP-IB address codes.

HP-IB Functions

Input Mode Functions: All front panel controls except the ac power line switch are programmable. Functions that require numerical values typically have greater entry resolution than is displayed. Several special HP-IB functions are provided that are not available from the front panel.

Frequency Resolution: Same as $CF/\Delta F$ plus vernier.

Power Resolution: Refer to RF plug-in unit specifications.

Output Mode Functions: The 8350A can output to a controller an instrument state message that completely describes the present instrument status (sweep mode, trigger mode, etc.) and can supply the present numerical value of any function (sweep time, marker frequencies, power levels, start/stop frequencies, etc.).

GENERAL**Nonvolatile Memory**

Option 001: Continuous memory that retains the contents of all instrument state storage registers and the HP-IB address along with the current instrument state when the ac power is turned off for approximately 20 days.

Display Blanking Outputs

POS Z BLANK: Direct-coupled rectangular

pulse approximately +5 volts during retrace and bandswitch points of sweep. Intensity marker signals are also output through this rear panel BNC connector. Marker signals are -4 volt pulses with the exception of the active marker which is -8 volts.

NEG Z BLANK: Direct-coupled rectangular pulse approximately -5 volts during retrace and bandswitch points of sweep. No markers are output from this rear panel BNC connector.

Pen Lift Output: Output to control the pen lift function of an X-Y recorder. Maximum sink current is approximately 600ma.

Rear Panel Programming Connector: Additional control of and information on the 8350A instrument state is provided via a 25-pin rear panel connector. Output signals such as display and RF blanking, X-Y recorder pen lift, HP 8410B and HP 5343A interface signals. Input signals affect the sweep status, display and RF blanking, pen lift outputs, etc. Refer to Figure 2-7 for a complete listing of signals and voltages on the rear panel Programming Connector.

8410B Interface Cable: Permits multi-octave operation of HP 8410B Network Analyzer with the 8350A (order HP Part Number 08410-60146). Connects between 8410B rear panel SOURCE CONTROL and 8350A rear panel PROGRAMMING CONNECTOR.

Furnished: 2.29m (7.5 foot) power cable with NEMA plug; spare fuses; two extender boards for servicing; 1.0m (3.3 foot) HP-IB cable.

Operating Temperature Range: 0°C to +55°C.

Power: 100, 120, 220, or 240 volts, +5% -10%, 50 to 60 Hz (Option 400; 60 to 400 Hz). Approximately 270 volt-amps including RF plug-in unit (depends upon specific RF plug-in unit used).

Weight (not including RF plug-in unit): Net 16.5 kg (36.4 lb) Shipping 22.7 kg (50 lb).

Dimensions: 425 W, 133.3 H, 422 mm D (16.75 x 5.25 x 16.6 in).

1-7. SPECIFICATIONS

1-8. Listed in Table 1-1 are the specifications for the Model 8350A Sweep Oscillator. These specifications are the performance standards, or limits, against which the instrument may be tested. Only the specifications for the Model 8350A Sweep Oscillator mainframe are given in this manual. Refer to the Operating and Service Manual for the specific RF plug-in used for complete specifications relating to the RF plug-in. Table 1-2 lists the sweep oscillator supplemental characteristics. Supplemental characteristics are not specifications but are typical characteristics included as additional information for the user.

1-9. SAFETY CONSIDERATIONS

1-10. General

1-11. This product and related documentation must be reviewed for familiarization with safety markings and instructions before operation. This product has been manufactured and tested in accordance with international safety standards.

1-12. Safety Symbols

1-13. A complete listing of the safety symbols used in this manual is given on the page preceding Figure 1-1. Included are descriptions of symbols which refer the operator to the manual from the instrument, Protective Earth Ground, Frame or Chassis Terminals, Warning, and Caution symbols.

1-14. INSTRUMENTS COVERED BY MANUAL

1-15. Attached to the rear panel of the instrument is a serial number plate. A typical serial number plate is shown in Figure 1-2. The serial

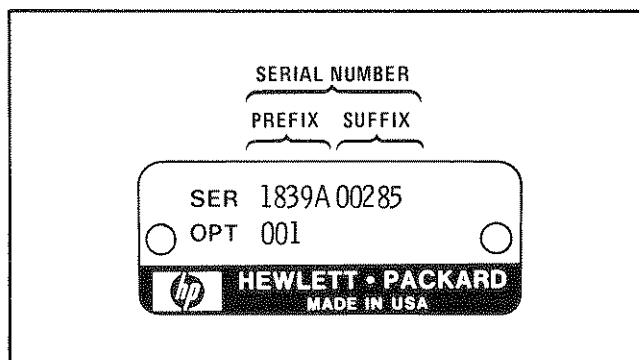

Figure 1-2. Typical Serial Number Plate

number is in two parts. The first four digits followed by a letter comprise the serial number prefix. The last five digits form the sequential suffix that is unique to each instrument. The content of this manual applies directly to instruments having the same serial number prefix as those listed on the title page of this manual under SERIAL NUMBER.

1-16. An instrument manufactured after the printing of this manual may have a serial prefix that is not listed on the title page. An unlisted serial prefix indicates that the instrument is different from those documented in this manual. The manual for the instrument is then supplied with a Manual Changes supplement that contains information that documents the differences.

1-17. In addition to change information, the Manual Changes supplement contains information for correcting errors in the manual. To keep this manual as current as possible, Hewlett-Packard recommends that you periodically request the latest Manual Changes supplement. The supplement for this manual is keyed to the manual's print date and part number, both of which appear on the title page. Complimentary copies of the Manual Changes supplement are available on request from Hewlett-Packard.

1-18. For information concerning a serial number prefix that is not listed on the title page or in the Manual Changes Supplement, contact your nearest Hewlett-Packard Sales/Service Office.

1-19. DESCRIPTION

1-20. The Hewlett-Packard Model 8350A Sweep Oscillator, together with an RF plug-in unit, forms a complete, solid-state, swept signal source. The Model 8350A can be used with network analyzer systems such as the HP Model 8410B Network Analyzer, the HP Model 8755 Frequency Response Test Set, and the HP Microwave Link Analyzers to provide a complete measurement system.

1-21. The front panel of the Model 8350A has been conveniently laid out to optimize the use of instrument operation function blocks. Frequency modes, sweep modes, marker operation, storage register control, and data entry controls are individually grouped for ease of operation and full control versatility on the Model 8350A Sweep Oscillator.

1-22. Upon initial turn on, or after the INSTRUMENT PRESET pushbutton is selected, the instrument automatically goes through an internal self check routine to verify proper instrument operation. If certain errors or failures are detected during the self test or in normal operation, they are indicated via error codes displayed on the far left digital display. An INSTRUMENT PRESET condition is then set which automatically presets the sweep oscillator to full RF plug-in band sweep operation.

1-23. Accurate High Resolution Data Entry

1-24. Accurate, high resolution digital displays indicate all major function values. Function values may be set by activating the appropriate pushbutton and using the corresponding knob, step keys, or data entry keyboard to enter the desired values.

1-25. Sweep and Trigger Modes

1-26. The sweep may be triggered INTERNALLY, through ac power LINE frequency, EXTERNALLY, or in SINGLE sweep operation. SWEEP TIME is continuously variable from 10 ms to 100 seconds. (Minimum sweep time may be greater than 10 ms depending upon the specific RF plug-in used and the bandwidth being swept). A MANUAL SWEEP function allows the data entry controls to provide continuous manual adjustment of frequency between the end frequencies set in any of the sweep functions. A direct coupled sawtooth sweep ramp, zero to approximately 10 volts, is available through both front and rear panel SWEEP OUTPUT/SWEEP INPUT BNC connectors.

1-27. START/STOP Mode

1-28. The START/STOP frequency sweep mode, selected upon Instrument Preset, is indicated by yellow LEDs located above the selected operation pushbuttons. In this mode the Model 8350A sweeps up from the START frequency to the STOP frequency. START and STOP frequencies are indicated on the FREQUENCY LED displays. START frequency or STOP frequency may then be changed through the use of the data entry controls.

1-29. CW Mode

1-30. When CW (Continuous Wave) mode is selected, the instrument is tuned to a single

frequency RF Output, indicated on the FREQUENCY LED display. CW mode operation is indicated by the yellow LED located above the CW pushbutton. CW frequency, when enabled, may be varied through the use of the data entry controls. When the SHIFT CW mode is selected, a 0 to 10 volt sweep ramp will be output at the front and rear panel SWEEP OUTPUT/SWEEP INPUT BNC connectors, even though the RF frequency is fixed in the CW mode.

1-31. CF/ Δ F Mode

1-32. The CF/ Δ F frequency sweep mode allows the instrument to sweep upward in frequency, symmetrically centered about a CF (Center Frequency) setting. CF/ Δ F sweep mode operation is indicated by the yellow LEDs centered above the CF and Δ F pushbuttons. CF and Δ F frequencies may be individually varied through use of the data entry controls. START/STOP and CF/ Δ F sweep modes may be interchanged without affecting the RF Output. When changing between CF/ Δ F sweep mode and CW mode, the CW frequency and the Center Frequency (CF) are equivalent.

1-33. Frequency Marker Operation

1-34. Five independent, continuously variable, amplitude or intensity markers are available to note significant points on the frequency sweep. Marker selection is indicated by a yellow LED located within each Marker pushbutton. Marker frequency is indicated on the FREQUENCY/TIME LED display. The frequency difference between any two markers can be displayed by the MKR Δ function. A MKR SWEEP function allows a frequency sweep using Marker 1 and Marker 2 as the START/STOP frequency limits while maintaining the original START/STOP values. For greater accuracy, marker frequencies can also be counted directly using the HP Model 5343A Microwave Frequency Counter. The sweep is momentarily stopped allowing the counter to measure the START, STOP, or activated marker frequency.

1-35. Instrument State Storage

1-36. Up to 9 different front panel settings can be stored and recalled in the Model 8350A via the SAVE n (n=1 through 9) function. The ALT n function causes the RF Output to alternate on successive sweeps between the current front panel setting and the setting stored in the recalled memory location (n=1 through 9). This allows the

Model 8350A to work in conjunction with the HP Model 8755 Frequency Response Test Set to allow two different measurements to be made simultaneously by utilizing two different sweep widths and/or power levels.

1-37. Modulation Characteristics

1-38. The Model 8350A is capable of internally square wave modulating the RF Output at a 27.8 kHz or 1 kHz (selected by an internal jumper) modulation frequency, as controlled by the front panel Square Wave Modulation pushbutton. The RF Output may also be Amplitude or Frequency modulated by an external source via the Model 8350A Sweep Oscillator rear panel inputs.

1-39. Remote Programming (HP-IB)

1-40. All front panel controls, except the line power switch, may be controlled or programmed remotely via the rear panel HP-IB interface connector. The Model 8350A can also output to a controller an instrument state message that completely describes the current instrument status (sweep mode, trigger mode, etc.) and can supply the present numerical value of any function (sweep time, marker frequencies, power levels, START/STOP frequencies, etc.).

1-41. Other Features

1-42. The Model 8350A also provides RF output blanking during sweep retrace and rear panel positive and negative polarity display blanking outputs for retrace and bandswitching points of sweep. A rear panel PEN LIFT output generates a pulse which is coincident in time with the endpoints of the sweep. A COUNTER TRIGGER output and STOP SWEEP input are also available on the rear panel to interface with the HP Model 5343A Microwave Frequency Counter. A 25-pin rear panel Programming Connector provides additional control of and information on the Model 8350A instrument state. A listing of pin configuration and signals on the Programming Connector is given in Figure 2-7. Output signals on the Programming Connector supplement other rear panel output signals such as display and RF blanking, X-Y recorder penlift, and HP Model 8410B and HP Model 5343A interface signals. Input signals on the Programming Connector affect the sweep status, display and RF blanking, penlift outputs, etc.

1-43. To have a complete operating unit, the Model 8350A Sweep Oscillator must be used in conjunction with an RF plug-in unit which operates in the desired frequency range. The HP Model 83500 Series RF Plug-in units have been specifically designed for use with the Model 8350A. With the addition of the Model 11869A RF Plug-in Adapter, the HP Model 86200 Series RF Plug-ins may also be used with the Model 8350A.

1-44. OPTIONS

1-45. Option 001, Nonvolatile Memory

1-46. Option 001 instruments contain a battery pack (inserted in the battery holder with a battery hold down clamp) and a special A3 Microprocessor board. With Option 001 installed, the Model 8350A has a nonvolatile memory which retains the contents of all instrument state storage registers, the current instrument state, and the HP-IB address. When fully charged, the batteries will retain a sufficient charge to hold the memory contents for approximately 20 days. The batteries are charged within the instrument and a full charge is maintained when the instrument LINE switch is ON.

1-47. An Option 001 Battery Kit may be ordered for standard Model 8350A Sweep Oscillators to upgrade them to Option 001 capability by ordering HP Part Number 08350-60013. This kit contains a battery pack, a battery pack hold down clamp, and a special A3 Microprocessor board. All other necessary wiring and hardware connections have been made at the factory on all standard instruments.

1-48. Option 400, 400 Hz AC Power Operation

1-49. The standard Model 8350A requires that the ac power line frequency be 50 to 60 Hz. Option 400 allows the instrument to operate with a 400 Hz ac power line frequency.

1-50. Option 907, Front Handles Kit

1-51. Option 907, HP Part Number 5061-0089, contains a pair of front handles and the necessary hardware for mounting the handles to the Model 8350A. Refer to Section II of this Operating and Service Manual for a detailed description of this kit and instructions for installation.

1-52. Option 908, Rack Mount Kit

1-53. Option 908, HP Part Number 5061-0077, contains a pair of flanges and the necessary hardware to mount the Model 8350A in an equipment rack with 482.6 mm (19 inches) horizontal spacing. Refer to Section II of this Operating and Service Manual for a detailed description of this kit and instructions for installation.

1-54. Option 909, Rack Mount/Front Handles Kit

1-55. Option 909, HP Part Number 5061-0083, contains one Option 907 Front Handles Kit and one Option 908 Rack Mount Kit (see descriptions in preceding paragraphs). Refer to Section II of this Operating and Service Manual for a detailed description of this kit and instructions for installation.

1-56. Option 910, Extra Operating and Service Manual

1-57. The standard instrument is supplied with one Operating and Service Manual. Each Option 910 provides one additional Operating and Service Manual. To obtain additional Operating and Service Manuals after initial shipment, order by manual part number, listed on the title page and rear cover of this manual.

1-58. ACCESSORIES SUPPLIED

1-59. Figure 1-1 shows the Model 8350A and power cable. The power cable supplied depends upon the country of destination. Refer to Section II of this manual for HP Part Number information.

1-60. EQUIPMENT REQUIRED BUT NOT SUPPLIED

1-61. To have a complete operating sweep oscillator, the Model 8350A Sweep Oscillator must have an RF plug-in unit installed. The HP 83500 Series RF Plug-ins have been specifically designed for use with the Model 8350A. They provide calibrated output power levels, calibrated power sweeps, internal leveling and slope control, and full HP-IB programmability. Economical use of the HP Model 86200 Series RF Plug-ins may be utilized with the Model 8350A with the addition of the HP Model 11869A RF Plug-in Adapter. The Model 11869A mounts at the rear of the Model

86200 Series RF Plug-in and provides the interface for signals and voltages from the Model 8350A to the RF plug-in. All of the Model 8350A standard operating features including HP-IB remote programming are available, however, specific RF plug-in functions (output power level, RF on/off, etc.) cannot be controlled or remotely programmed by the Model 8350A mainframe.

1-62. To use the HP-IB capabilities of the Model 8350A, a computing controller such as the HP 9825 Desktop Computer or the HP 85 Personal Computer is needed.

1-63. EQUIPMENT AVAILABLE**1-64. Service Accessories**

1-65. A Service Accessory Kit (HP Part Number 08350-60020) is available for servicing the 8350A and 83500-series RF plug-ins. The accessory kit includes:

- Two 44-pin printed circuit board extenders. The HP Part Number for each extender is 08350-60031. These boards have keyed slots which allow them to be used in troubleshooting the Model 83500-series RF Plug-ins as well.
- An RF Plug-in extender cable set that provides all electrical connections when the RF Plug-in is removed from the sweep oscillator. The RF Plug-in Interface Connector is extended by one cable (HP Part Number 08350-60034) and the Power Supply Interface connector is extended by the other cable (HP Part Number 08350-60035).
- One hex Balldriver (HP Part Number 8710-0523). Used to remove the hold down plate hex screws from the front panel when repair is necessary.
- One 16-pin I.C. Test Clip (HP Part Number 1400-0734) and one 20-pin I.C. Test Clip (HP Part Number 1400-0979) are provided as an aid for probing Integrated Circuits when troubleshooting.

1-66. Model 8410B/8411A Network Analyzer

1-67. The Model 8350A Sweep Oscillator is compatible with the HP Model 8410B Network Analyzer system. The combination of the Model

8410B Network Analyzer, the Model 8411A Frequency Converter, and an appropriate display plug-in forms a phasemeter and a ratiometer for direct phase and amplitude ratio measurement on RF voltages. These measurements can be made on single frequencies and on swept frequencies from 110 MHz to 18 GHz. Several RF plug-in units for the Model 8350A are capable of multi-octave sweeps in this range. The Model 8410B has an Auto-Frequency range mode which gives it the capability of automatically tracking the Model 8350A Sweep Oscillator over octave and multi-octave frequency bands. Two interconnections to the Model 8350A are necessary to ensure that the Model 8410B will phase lock properly. The Model 8410B Source Control Cable (HP 08410-60146) connects the Model 8410B rear panel SOURCE CONTROL connector to the Model 8350A rear panel PROGRAMMING CONNECTOR. Additionally, the sweep oscillator RF plug-in 1V/GHz output connects to the Model 8410B rear panel FREQ REF INPUT. The Model 8410B Source Control Cable connector pins and signals are illustrated in Table 1-3.

1-68. Model 8755 Frequency Response Test Set

1-69. The Model 8350A Sweep Oscillator is compatible with the Model 8755 Frequency Response Test Set for broadband swept scalar

measurements. The Model 8350A provides internal 27.8 kHz square wave modulation of the RF output eliminating unnecessary cable connections to the Model 8755 or the use of an external modulator. The Model 8350A can also produce alternate sweeps through use of the ALT n function which works in conjunction with the channel switching circuits in the Model 8755C. This permits Channel 1 on the Model 8755C to respond only to the Model 8350A current state and Channel 2 to the alternate state. A single cable (HP Part Number 8120-3174) connects between the Model 8350A rear panel ALT SWP INTERFACE connector and the Model 8755C front panel ALT SWP INTERFACE connector.

1-70. Power Meters and Crystal Detectors

1-71. Depending upon the RF plug-in unit used, the RF output can be externally leveled using the HP Model 432 Power Meter or negative polarity output crystal detectors. Refer to the Operating and Service Manual of the specific RF plug-in used for detailed information on leveling systems that may be used with the Model 8350A/RF Plug-in combination.

NOTE

The Model 435A and 436A Power Meters should not be used in Model 8350A external leveling systems.

Table 1-3. Model 8410B Source Control Cable

8410B Source Control Cable - HP Part Number 08410-60146				
Mnemonic	Description	8350A Connector Pin (25-pin D Type Male HP Part No. 1251-0063)	8410B Connector Pin (14-pin Micro Ribbon Male HP Part No. 1251-0142)	Wire Color Code
L SSRQ	Low = Stop Sweep Request	18	7	905
SYNC TRG	High = Synchronizing Trigger	24	1	901
GND DIG	Digital Ground	19	11	90

Table 1-4. Recommended Test Equipment¹ (1 of 4)

Instrument	Critical Specifications	Recommended Model	Use ²
Spectrum Analyzer	Frequency Range: 0.01 to 22 GHz Residual FM: ≤ 100 Hz Must have auxiliary IF output when used with the HP 8901A Modulation Analyzer.	HP 8565A	P,T
Oscilloscope	Dual channel X vs. Y display mode Sensitivity: ≤ 0.1 μ S/DIV Horizontal Sweep Rate: ≤ 0.1 μ S/DIV	HP 1740A	P
Display Mainframe	Compatible with HP 8755C Swept Amplitude Analyzer and HP 8750A Storage-Normalizer	HP 182T, 180TR	P
Swept Amplitude Analyzer	Capable of transmission measurements Power Resolution: ≤ 0.25 dB/DIV	HP 8755C	P
Detector	Compatible with Swept Amplitude Analyzer Frequency Range: 0.01 to 12.4 GHz Power Range: -20 to $+10$ dBm	HP 11664A	P
Power Splitter	Frequency Range: 0.01 to 12.4 GHz Output Port Tracking: ≤ 0.25 dB Maximum Input Power: $\geq +20$ dBm	HP 11667A	P
Storage-Normalizer	Compatible with Display Mainframe and Swept Amplitude Analyzer	HP 8750A	P
Digital Voltmeter	Accuracy: $\leq 0.005\%$ Input Impedance: ≥ 10 M Ω	HP 3455A	A,T
Universal Counter	Frequency Mode Frequency Range: ≥ 30 kHz Frequency Resolution: ≤ 10 Hz Time Period Mode Frequency Range: ≥ 20 kHz Resolution: ≤ 50 μ S	HP 5328A	A
Oscilloscope Probe	1 : 1 General Purpose Probe	HP 10008B	A
Modulation Analyzer	(May be used in addition to Spectrum Analyzer) Frequency Range: Must cover auxiliary IF Output frequency of Spectrum Analyzer used Residual FM: ≤ 10 Hz	HP 8901A	P
Power Meter	Power Range: -20 to $+10$ dBm (No substitution when used for external power meter leveling).	HP 432A	P

Table 1-4. Recommended Test Equipment¹ (2 of 4)

Instrument	Critical Specifications	Recommended Model	Use ²
Thermistor Sensor	Frequency Range: 0.01 to 12.4 GHz Maximum SWR: ≤ 1.75	HP 8478B	P
Frequency Counter	Frequency Range: 0.01 to 12.4 GHz Sensitivity: ≤ -20 dBm Maximum Input Power: ≥ 0 dBm Frequency Accuracy: ≤ 1 kHz	HP 5343A	P
Directional Coupler	Frequency Range: 0.1 to 2.0 GHz Nominal Coupling: ≥ 20 dB Maximum Coupling Variation: $\leq \pm 1$ dB Minimum Directivity: ≥ 32 db	HP 778D	P
Directional Coupler	Frequency Range: 2 to 12.4 GHz Mean Output Coupling: ≥ 20 dB Output Coupling Variation: $\leq \pm 1$ dB Minimum Directivity: ≥ 26 dB	HP 779D	P
RMS Voltmeter	dB Range: -20 to -70 dBm (0 dBm = 1 mW into 600 Ohms) Frequency Range: 10 Hz to 10 MHz Accuracy: $\pm 5\%$ of full scale	HP 3400A	P
Function Generator	Frequency Range: 0.1 Hz to 10 MHz Output Level: 10V p-p into 50 Ohms Output Level Flatness: $\leq \pm 3\%$ from 10 Hz to 100 kHz $\leq \pm 10\%$ from 100 kHz to 10 MHz	HP 3312A	P,T
Crystal Detector	Frequency Response: 0.01 to 12.4 GHz Maximum Input Power: ≥ 100 mW	HP 423B	P
Air Line Extension (2 required)	Impedance: 50 Ohms Frequency Range: dc to 12.4 GHz Reflection Coefficient: 0.018 + 0.001 (times the frequency in GHz)	HP 11567A	P
RF Cable	Impedance: 50 Ohms Length: 61 cm (24 in.)	HP 11170B	P
Step Attenuator	Frequency Range: dc to 12.4 GHz Incremental Attenuation: 0 to 70 dB in 10 dB steps Calibration Accuracy: $\leq \pm 0.1$ dB at all steps	HP 8495A Option 890	P

Table 1-4. Recommended Test Equipment¹ (3 of 4)

Instrument	Critical Specifications	Recommended Model	Use ²
Attenuator	Attenuation: 3 dB \pm 0.5 dB Frequency Range: 0.01 to 12.4 GHz Maximum Input Power: \geq +20 dBm	HP 8491B Option 003	P
Attenuator	Attenuation: 6 dB \pm 0.5 dB Frequency Range: 0.01 to 12.4 GHz Maximum Input Power: \geq +20 dBm	HP 8491B Option 006	P
Attenuator	Attenuation: 10 \pm 0.5 dB Frequency Range: 0.01 to 12.4 GHz Maximum Input Power: \geq +20 dBm	HP 8491B Option 010	P
Attenuator	Attenuation: 20 \pm 0.5 dB Frequency Range: 0.01 to 12.4 GHz Maximum Input Power: \geq +20 dBm	HP 8491B Option 020	P
Adjustable Short	Frequency Range: 1.8 to 12.4 GHz Impedance: 50 \pm 1.5 Ohms	Maury Microwave ³ 1953-2	P
Adjustable AC Line Transformer	Select to cover line voltage used 100—120 volt	General Radio ⁴ W5MTB	P
	220—240 volt	General Radio W10HM73	P
Line Voltage Monitor	To be used with above Adjustable AC Line Transformers 120 volt Monitor	RCA ⁵ 120B	P
	240 volt Monitor	RCA WV 503A	P
Frequency Meters	Frequency Accuracy: \leq 0.17% Calibration Increments: \leq 2 MHz Select to cover Frequency range of RF plug-in 0.96 to 4.2 GHz	HP 536A	P
	3.7 to 12.4 GHz	HP 537A	P
Adapter	APC-7 to Type N(m)	HP 11525A	P
Adapter	APC-3.5(f) to Type N(m)	Amphenol ⁶ 131-7018	P
Delay Line Discriminator	Refer to Figure 1-3		P

Table 1-4. Recommended Test Equipment¹ (4 of 4)

Instrument	Critical Specifications	Recommended Model	Use ²
PC Board Extender ⁷	44-pin, extends printed circuit boards	HP Part Number 08350-60031 (each)	T
RF Plug-in Extender Cable	Extends RF Plug-in Interface Connector (J2)	HP Part Number 08350-60034	T
RF Plug-in Extender Cable	Extends RF Plug-in Power Supply Interface Connector (J3)	HP Part Number 08350-60035	T

¹Refer to the Recommended Test Equipment list in the Operating and Service Manual of the RF plug-in used for a listing of equipment specifically relating to the RF plug-in used. Not all equipment included in this list is necessary for all RF plug-ins.

²P=Performance Test; A=Adjustments; T=Troubleshooting

³Mauray Microwave Corp., 8610 Helms Ave., Cucamonga, CA 91730

⁴General Radio, 300 Baker Avenue., Concord, MA 01742

⁵RCA Distribution & Special Products Div., Dept. EM, New Holland Ave., Lancaster, PA 17604

⁶Amphenol North America, Bunker-Ramo Corp., RF Operations, 33 E. Franklin St., Danbury, CT 06810

⁷Two 44-pin printed circuit board extenders and a fuse kit are included with the Model 8350A Accessory Kit Supplied (HP Part Number 08350-60020). Refer to Figure 1-1 in this manual.

1-72. RECOMMENDED TEST EQUIPMENT

1-73. Equipment required for testing and adjustment of the instrument is listed in Table 1-4. Other equipment may be substituted if it meets or exceeds the critical specifications indicated in the table.

1-74. HEWLETT-PACKARD INTERFACE BUS. (HP-IB)

1-75. The Model 8350A is factory equipped with

a remote programming interface using the Hewlett-Packard Interface Bus (HP-IB). This provides a remote operator with the same control of the instrument available to a manual (local) operator. Remote control is maintained by a system controller (desktop computer, computer, etc.) that sends commands or instructions to and receives data from the Model 8350A using the HP-IB. The HP-IB is Hewlett-Packard's implementation of the IEEE Standard 488-1978. A complete general description of the HP-IB is provided in the manual entitled "Condensed Description of the Hewlett-Packard Interface Bus" (HP Part Number 59401-90030).

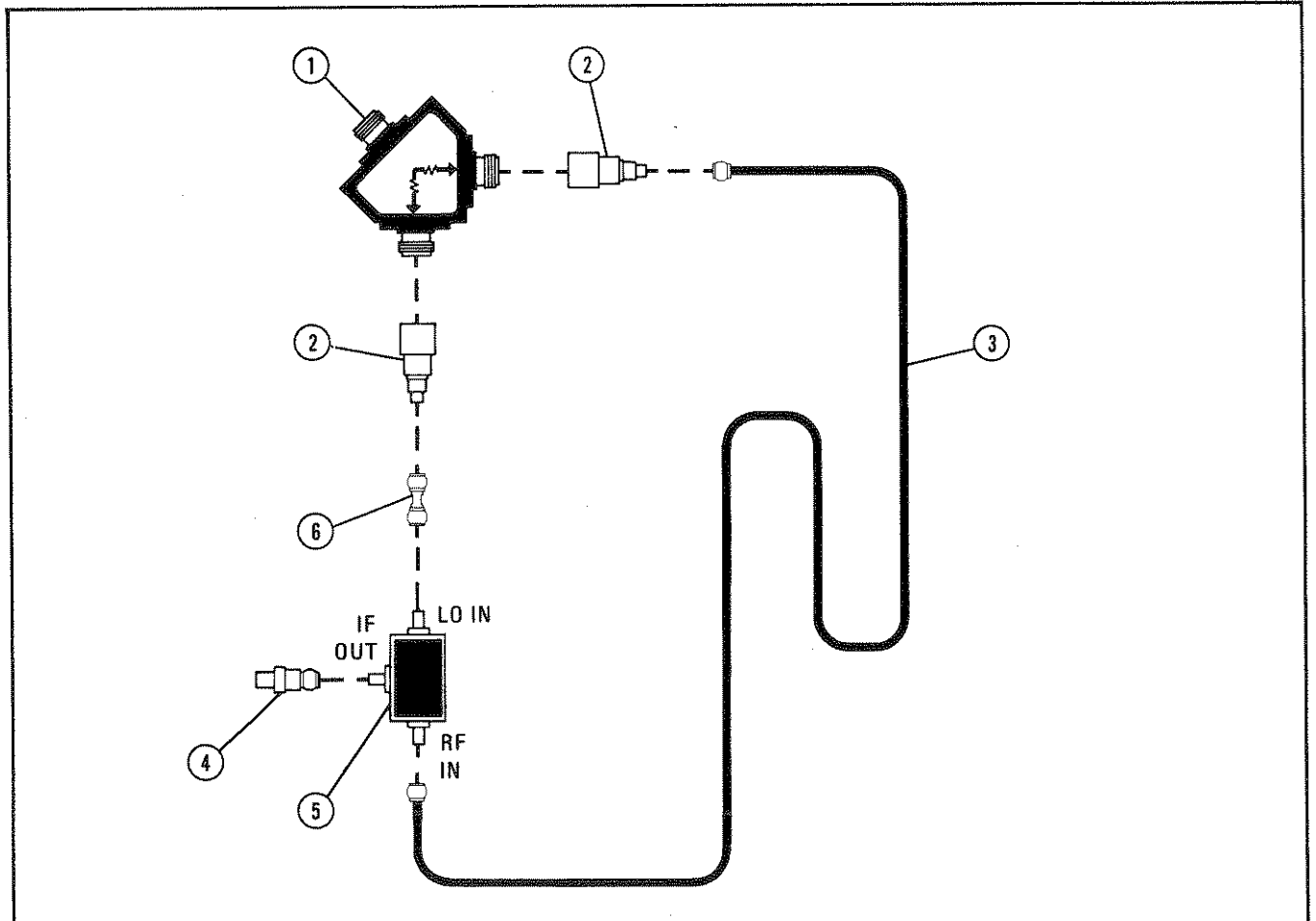

Item	Description	HP Part Number
1	Power Splitter	HP 11667A
2	Adapter: Type N Male to SMA Female (2 required)	1250-1250
3	Delay Line: >1 meter (3 feet) in length, SMA male connectors	08350-20038
4	Adapter: BNC Female to Male SMA	1250-1200
5	Mixer: Double Balanced 1 to 12 GHz: RHG Electronics Part No. DM 1-12 1 to 18 GHz: RHG Electronics Part No. DM 1-18 RHG Electronics Laboratories, Inc. Deer Park, NY 11729	0960-0451 None
6	Adapter: SMA Male to SMA Male	1250-1159

Figure 1-3. Delay Line Discriminator

SECTION II INSTALLATION

2-1. INTRODUCTION

2-2. This section provides installation instructions for the Model 8350A Sweep Oscillator and its accessories. This section also includes information about initial inspection and damage claims, preparation for use, and packaging, storage, and shipment.

2-3. INITIAL INSPECTION

2-4. Inspect the shipping container for damage. If the shipping container or cushioning material is damaged, it should be kept until the contents of the shipment have been checked for completeness and the instrument has been checked mechanically and electrically. The contents of the shipment should be as shown in Figure 1-1. Procedures for checking electrical performance are given in Section IV, Performance Tests, of this manual. If the instrument combination does not pass the electrical Performance Tests, refer to Section V, Adjustments, of this manual. If, after the adjustments have been made, the instrument combination still fails to meet specifications, refer to Section V, Adjustments, of the Operating and Service Manual for the RF plug-in being used. If a circuit malfunction is suspected, refer to troubleshooting procedures in Section VIII, Service, of this or the RF plug-in manual. If the instrument does not pass the above electrical tests, if the shipment contents are incomplete, or if there is mechanical damage or defect, notify the nearest Hewlett-Packard office. If the shipping container is damaged, or if the cushioning material shows signs of stress, notify the carrier as well as the Hewlett-Packard office. Keep the shipping materials for carrier's inspection. The HP office will arrange for repair or replacement without waiting for claim settlement.

2-5. PREPARATION FOR USE

2-6. Power Requirements

2-7. The Model 8350A Sweep Oscillator requires a power source of 100, 120, 220, or 240 Vac, +5% to -10%, 50 to 60 Hz, single-phase (50 to 400 Hz, single-phase for Option 400 instruments). Power consumption is approximately 270 volt-amps, depending upon the specific RF plug-in unit used.

2-8. Line Voltage and Fuse Selection

2-9. Figure 2-1 illustrates the line voltage selection card and fuse location in the Power Line Module on the rear panel of the Model 8350A. Select the line voltage and fuse as follows:

- a. Measure the ac line voltage.
- b. Refer to Figure 2-1. At the instrument rear panel power line module, select the line voltage (100, 120, 200, or 220 volts) closest to the voltage you measured in step a. Note the available line voltage must be within +5% or -10% of the line voltage selection as shown in Table 2-1. If it is not, you must use an autotransformer between the power source and the Model 8350A.

Table 2-1. Line Voltage/Fuse Selection

Measured ac Line Voltage	PC Selector Board Position	Fuse/HP Part Number
90 to 105 volts	100	4.0A 2110-0055
108 to 126 volts	120	4.0A 2110-0055
198 to 231 volts	220	2.0A 2110-0002
216 to 252 volts	240	2.0A 2110-0002

- c. Make sure the correct fuse is installed in the fuse holder. The required fuse rating for each line voltage is indicated in Table 2-1 and below the power line module on the rear panel of the Model 8350A.

cables. The type of power cable/plug shipped with the instrument depends upon the country of destination.

WARNING

Before switching on this instrument, be sure that only the specified power cable is used. The instrument is provided with a three-wire power cord which grounds the instrument cabinet. This power cord should only be inserted in a socket outlet provided with a protective earth contact. This protective action should not be negated by the use of an extension cord (power cable) without a protective conductor (ground). Grounding one conductor of a two-conductor outlet is not sufficient protection.

CAUTION

To prevent damage to the instrument, make the correct line voltage and fuse selection before connecting line power to the instrument.

2-10. Power Cable

2-11. In accordance with international safety standards, this instrument is equipped with a three-wire power cable. When connected to an appropriate power line outlet, this cable grounds the instrument cabinet. Table 2-2 shows the styles of plugs available on power cables supplied with HP instruments. The HP Part Numbers for the plugs are part numbers for the complete power

2-12. The offset pin of the three-prong connector is the grounding pin. When operating the Model 8350A from a two-contact outlet, the protective grounding feature may be preserved by using a three-prong to two-prong adapter (USA connectors only, HP Part Number 1251-0048) and connecting the green wire of the adapter to ground.

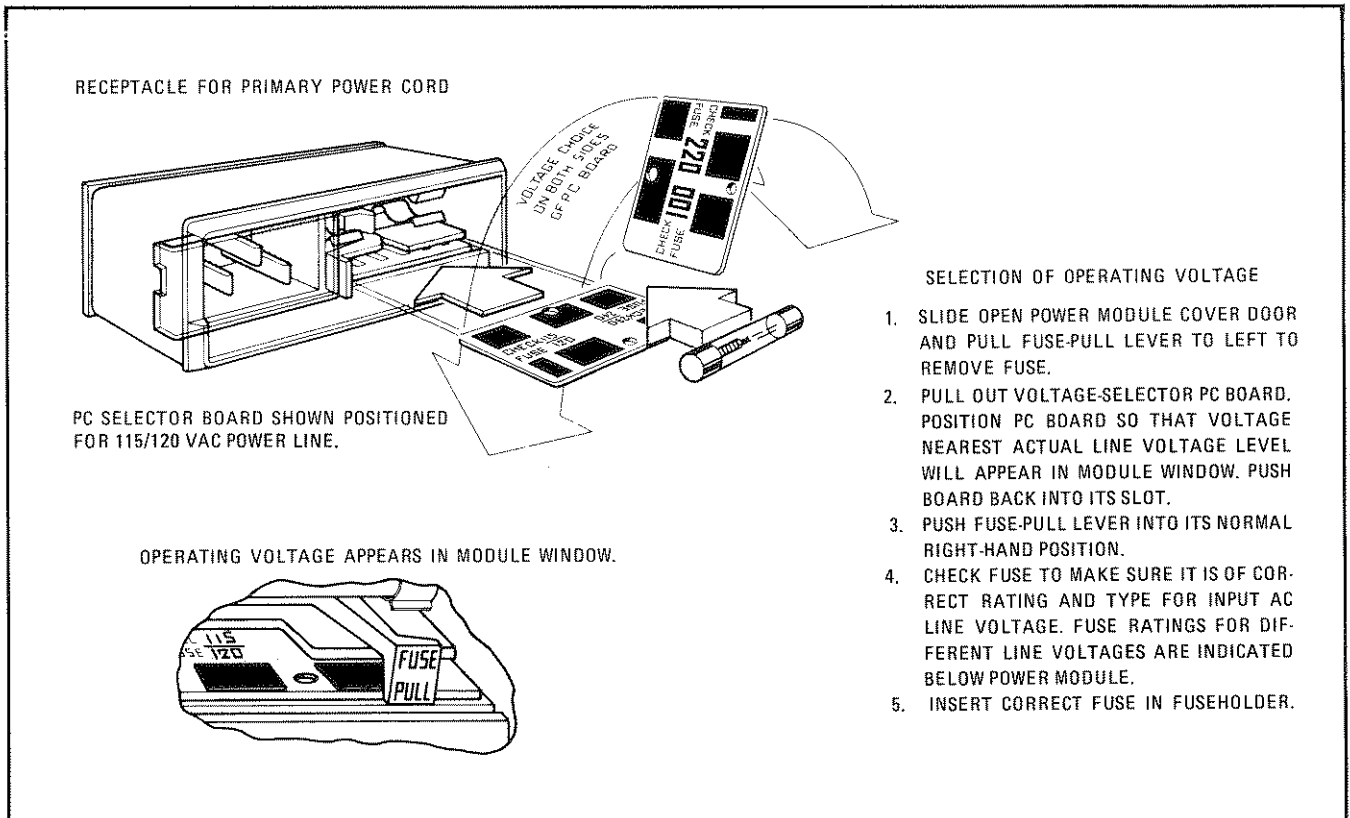
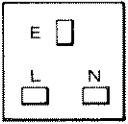
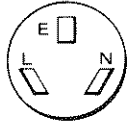
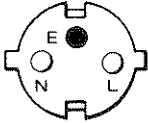
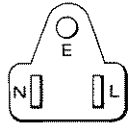
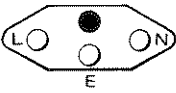
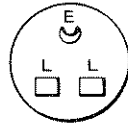
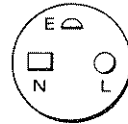
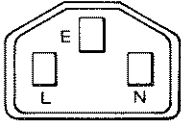

Figure 2-1. Power Line Module

Table 2-2. AC Power Cables Available

Plug Type	Cable HP Part Number	C D	Plug Description	Cable Length (inches)	Cable Color	For Use In Country
250V 	8120-1351 8120-1703	0 6	Straight*BS1363A 90°	90 90	Mint Gray Mint Gray	United Kingdom, Cyprus, Nigeria, Rhodesia, Singapore
250V 	8120-1369 8120-0696	0 4	Straight*NZSS198/ASC112 90°	79 87	Gray Gray	Australia, New Zealand
250V 	8120-1689 8120-1692	7 2	Straight*CEE7-Y11 90°	79 79	Mint Gray Mint Gray	East and West Europe, Saudi Arabia, Egypt So. Africa, India (unpolarized in many nations)
125V 	8120-1348 8120-1398 8120-1754 8120-1378 8120-1521 8120-1676	5 5 7 1 6 2	Straight*NEMA5-15P 90° Straight*NEMA5-15P Straight*NEMA5-15P 90° Straight*NEMA5-15P	80 80 36 80 80 36	Black Black Black Jade Gray Jade Gray Jade Gray	United States, Canada, Japan (100V or 200V), Mexico, Philippines, Taiwan
250V 	8120-2104	3	Straight*SEV1011 1959-24507 Type 12	79	Gray	Switzerland
250V 	8120-0698	6	Straight*NEMA6-15P			United States, Canada
220V 	8120-1957 8120-2956	2 3	Straight*DHCK 107 90°	79 79	Gray Gray	Denmark
250 V 	8120-1860	6	Straight*CEE22-VI (Systems Cabinet use)			

*Part number shown for plug is industry identifier for plug only. Number shown for cable is HP Part Number for complete cable including plug.
E = Earth Ground; L = Line; N = Neutral

2-13. HP-IB Address Selection

WARNING

The HP-IB address switch is set with the top cover removed from the Model 8350A and should be set only by a skilled person who is aware of the hazard involved. Prior to setting the HP-IB address switch, the LINE switch should be set to OFF and the power cord should be disconnected from the ac power source for maximum safety. Capacitors inside the instrument may still be charged even when the instrument is disconnected from its ac power source. Use caution when setting the HP-IB address switch to avoid touching assemblies or components within the instrument other than the HP-IB address switch.

2-14. When the Model 8350A is used under remote control with the HP-IB, the controller on the bus refers to the Model 8350A by an HP-IB "address". The Model 8350A is differentiated from any other instrument on the bus by its own unique address. This HP-IB address is initially preset in

the Model 8350A by a 5-segment address switch A8S1, located on the A8 HP-IB Interface assembly, as shown in Figure 2-2. A diagram of A8S1 is given in Figure 2-3. Each of the 5 switches corresponds to one of the digits of the 5-digit binary equivalent of the address, as shown in Table 2-3. A8S1 switch A1 corresponds to the Least Significant Bit (LSB) of the binary address and switch A5 corresponds to the Most Significant Bit. The HP-IB address can be modified by a front panel SHIFT function.

2-15. Thirty-one different address codes are available (decimal 0 to 30). The Model 8350A is shipped from the factory preset to binary address "10011" (decimal 19), as shown in Figure 2-3. In all standard Model 8350A instruments, the HP-IB address will be read by the processor from the HP-IB address switch A8S1 upon initial power on only. This HP-IB address will remain in effect until the address is changed by modifying the A8S1 switch pattern (and turning the LINE switch OFF and ON) or by resetting the address through the front panel SHIFT LOCAL function. The HP-IB address can be read directly from the front panel by pressing SHIFT LCL. The current HP-IB address is then displayed in decimal form on the FREQUENCY/TIME display. If the HP-IB

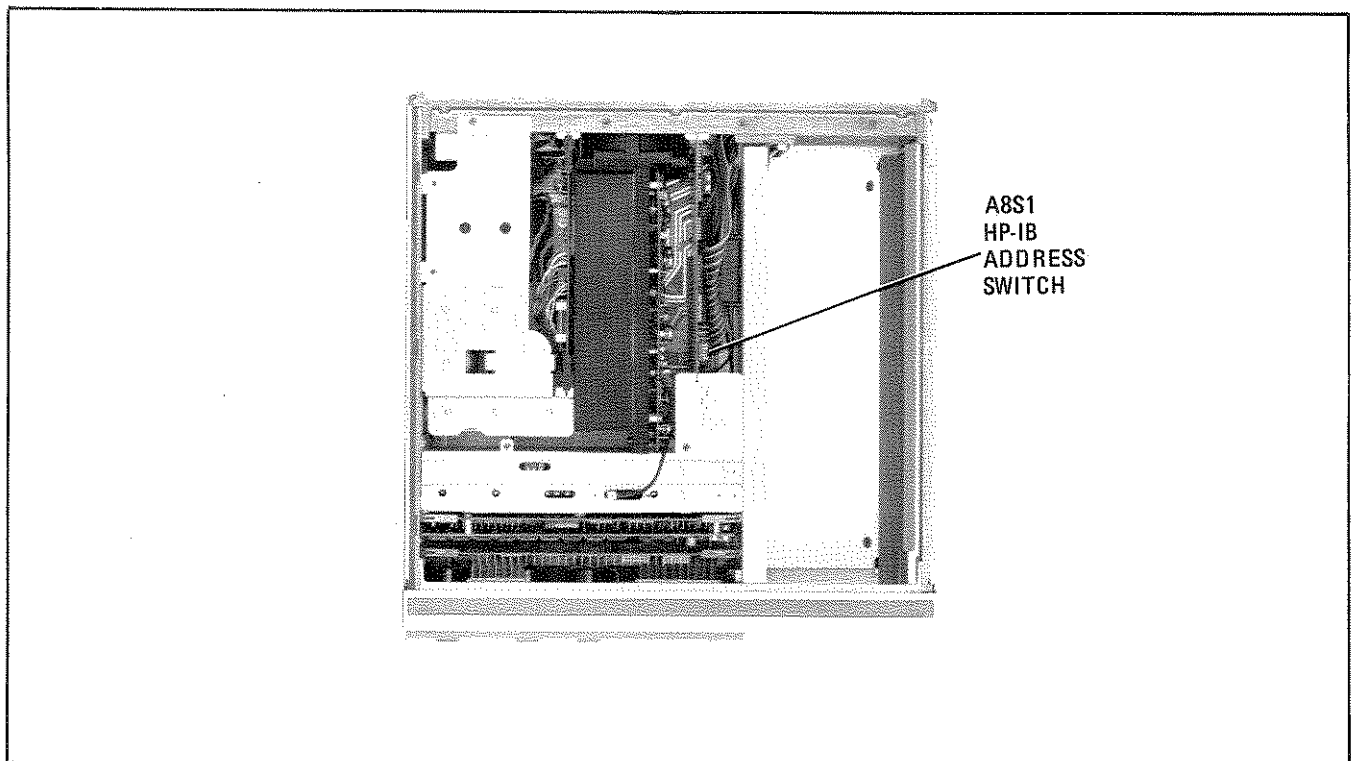

Figure 2-2. Location of A8S1 HP-IB Address Switch

address must be changed from that which is displayed, enter the new decimal equivalent of the desired HP-IB address and press **GHZ** to terminate the entry. The **FREQUENCY/TIME** display should now display the new HP-IB address. This address will remain in effect until the Model 8350A **LINE** switch is turned **OFF**. When the instrument **LINE** switch is set to **ON** once again, the HP-IB address will revert back to the **A8S1** address switch setting. An **INSTRUMENT PRESET** command will not modify the current HP-IB address setting.

2-16. Option 001 Model 8350A instruments contain a battery supported memory and a special **A3** Microprocessor board. The battery option allows the instrument memory to retain the assigned HP-IB address when the instrument is turned off, regardless of the **A8S1** address switch setting. Upon initial power on, the HP-IB address will need to be set to the desired code through the front panel **SHIFT LOCAL** function. The address will be retained as long as the battery is charged to a sufficient level. Refer to the **Battery Operation (Option 001)** paragraph in this section of the manual further information on Option 001 instruments.

2-17. HP-IB address labels are available by

ordering HP Part Number 7120-6853 (each). (See Figure 2-4). These labels allow easy reference to the HP-IB address of each system component.

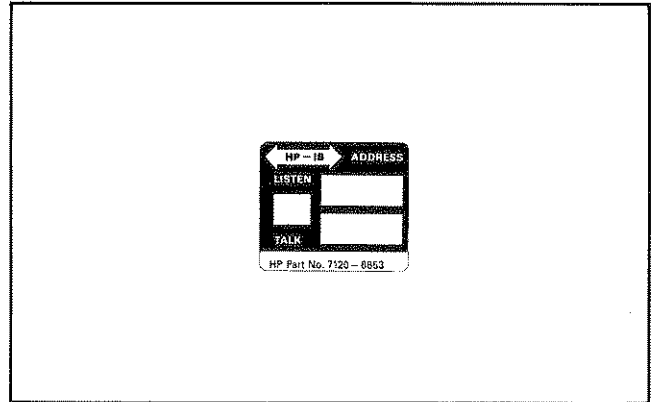

Figure 2-4. HP-IB Address Label

2-18. 11869A Switch Settings for HP 86200 Series RF Plug-ins

2-19. The identification switch on the Model 11869 RF Plug-in Adapter must be preset when using the adapter with HP 86200 Series RF Plug-ins in the Model 8350A. The setting of the identification switch is interrogated at power on, when the 8350A **INSTR PRESET** button is pressed, or when an HP-IB Instrument Preset

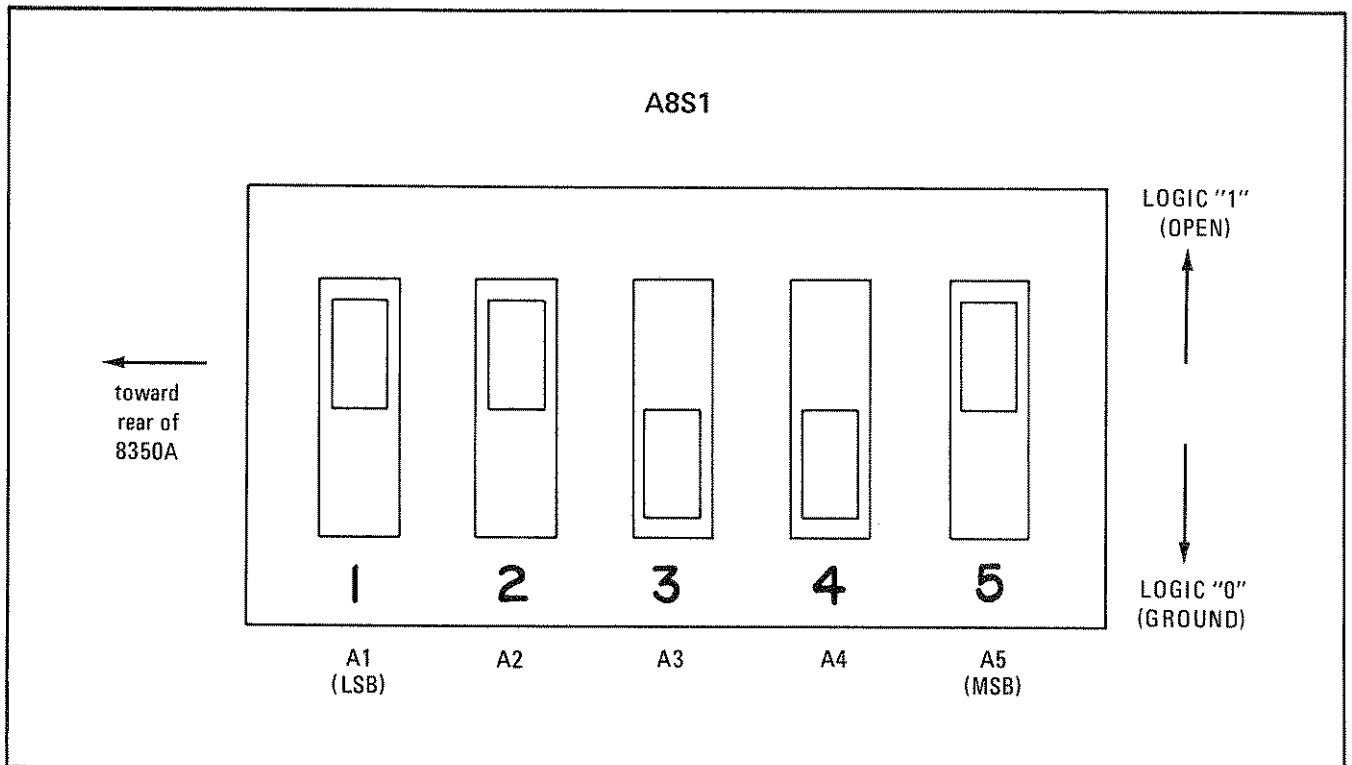

Figure 2-3. A8S1 HP-IB Address Switch

Table 2-3. HP-IB Address Codes

Address Characters		A8S1 Address Switch Settings					Address
Listen	Talk	(MSB)			(LSB)		Decimal Equivalent
		A5	A4	A3	A2	A1	
SP	@	0	0	0	0	0	0
!	A	0	0	0	0	1	1
”	B	0	0	0	1	0	1
#	C	0	0	0	1	1	3
\$	D	0	0	1	0	0	4
%	E	0	0	1	0	1	5
&	F	0	0	1	1	0	6
,	G	0	0	1	1	1	7
(H	0	1	0	0	0	8
)	I	0	1	0	0	1	9
*	J	0	1	0	1	0	10
+	K	0	1	0	1	1	11
,	L	0	1	1	0	0	12
-	M	0	1	1	0	1	13
.	N	0	1	1	1	0	14
/	O	0	1	1	1	1	15
0	P	1	0	0	0	0	16
1	Q	1	0	0	0	1	17
2	R	1	0	0	1	0	18
3	S	1	0	0	1	1	19
4	T	1	0	1	0	0	20
5	U	1	0	1	0	1	21
6	V	1	0	1	1	0	22
7	W	1	0	1	1	1	23
8	X	1	1	0	0	0	24
9	Y	1	1	0	0	0	25
:	Z	1	1	0	1	0	26
;	[1	1	0	1	1	27
<	/	1	1	1	0	1	28
=]	1	1	1	0	1	29
>	^	1	1	1	1	0	30

(“IP”) command is received. If the identification switch is set incorrectly, the START/STOP frequencies will be in error. Refer to Section II, Installation, of the Model 11869A Operating and Service Manual for instructions to properly set the identification switch.

2-20. Internal Square Wave Modulation Frequency Selection

2-21. Internal square wave modulation is available at all sweep speeds on the Model 8350A. Internal square wave modulation is selected by the front panel MOD pushbutton. Modu-

lation frequency is selectable by an internal jumper to be either 27.8 kHz (preset at the factory for use with Model 8755 Swept Amplitude Analyzer systems) or 1 kHz. Refer to Section V Adjustments in this manual for detailed information on how to select and adjust the internal square wave modulation frequency.

2-22. RF Plug-in Configuration Switch

2-23. Each RF plug-in may have a configuration switch which must be preset prior to operation in the Model 8350A. This is a multiple switch with individual switches that correspond to various RF

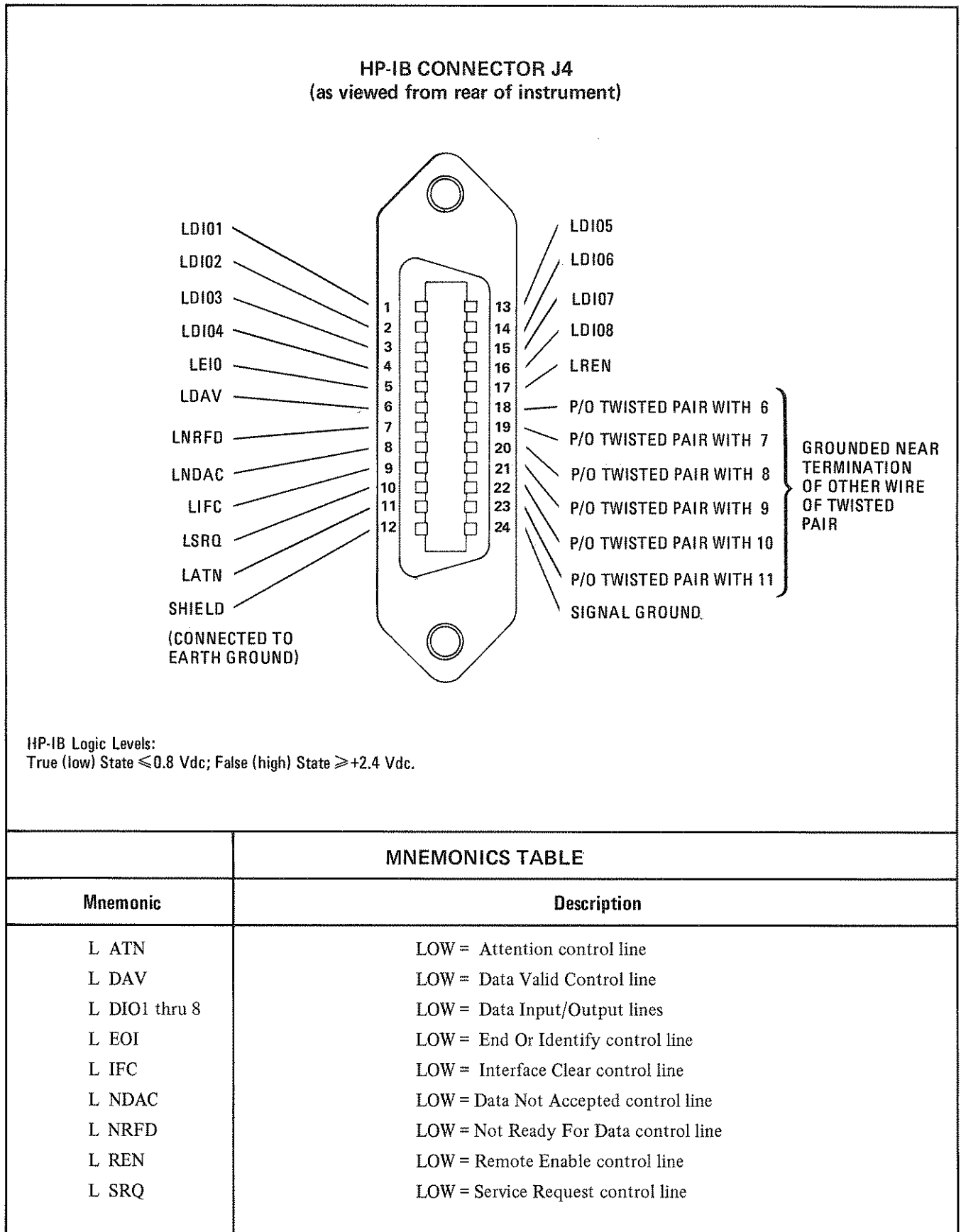

Figure 2-5. HP-IB Connector Signals and Pin Configuration

plug-in functions such as FM sensitivity selection, FM input coupling selection (direct coupled or cross-over), RF power level at instrument power on, and Option 002 Step Attenuator operation. Refer to the Operating and Service Manual of the specific RF plug-in used for detailed information on the configuration switch.

2-24. Interconnections

2-25. There are two RF plug-in interconnections on the Model 8350A Sweep Oscillator mainframe. These are the RF Plug-in Interface Connector (J2) and the Power Supply Interface Connector (J3). J2 and J3 are visible at the rear of the RF plug-in channel. A complete listing of pins and the associated signals and voltages for these connectors are listed on the overall instrument Wiring List in Section VIII, Service, of this manual.

2-26. Mating Connectors

2-27. All of the externally mounted connectors on the Model 8350A are listed in Table 2-4. Opposite each mainframe connector is an industry identification, the HP part number of a mating connector, and the part number of an alternate source for the mating connector. For HP part numbers of the externally mounted connectors themselves, refer to Section VI, Replaceable Parts, of this manual.

2-28. HP-IB Interface Connector and Cables

2-29. The HP-IB Interface Connector J4, located on the rear panel of the Model 8350A, allows the sweep oscillator to be connected to any other device on the HP-IB Interface Bus. A complete illustration of pin configuration and signals on the HP-IB Interface connector is given in Figure 2-5.

2-30. All instruments on the HP-IB Interface Bus are interconnected by HP-IB Interface Cables. A list of the available HP-IB Interface Cables and their part numbers is given in Figure 2-6. As many as 15 instruments can be connected in parallel on the HP-IB Interface Bus. To achieve design performance on the bus, proper voltage levels and timing relationships must be maintained. If the system cable is too long or if the accumulated cable length between instruments is too long, the data and control lines cannot be driven properly and the system may fail to perform. Therefore, the following restrictions must be observed:

- a. With two instruments in a system, the cable length must not exceed 4 meters (12 feet).
- b. When more than two instruments are connected on the bus, the cable length to each instrument must not exceed 2 meters (6 feet) per unit.
- c. The total cable length between all units cannot exceed 20 meters (65 feet).

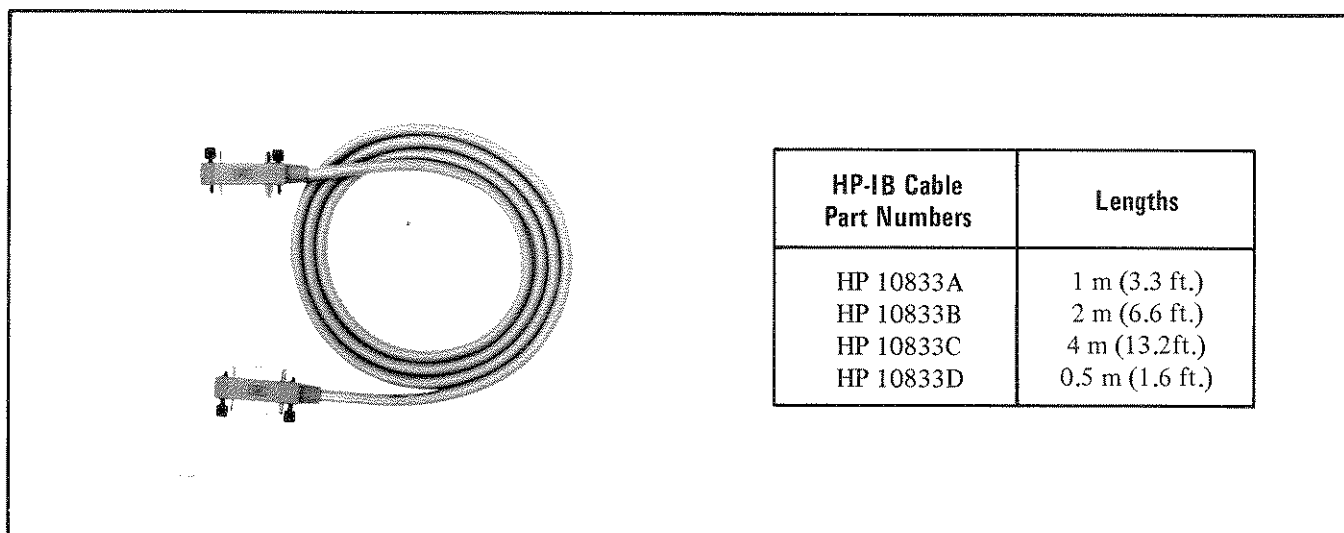

Figure 2-6. HP-IB Interface Cables Available

Table 2-4. Model 8350A Mating Connectors

8350A Connector		Mating Connector	
Connector Name	Industry Identification	HP Part Number	Alternate Source
J1 SWEEP OUTPUT/ SWEEP INPUT (front panel)	BNC	1251-0256	Specialty Connector 25-P118-1
J4 HP-IB INTERFACE BUS*	24-Pin Micro Ribbon	1251-0293	Amphenol 57-30240
J5 POS Z BLANK	BNC	1250-0256	Specialty Connector 25-P118-1
J6 NEG Z BLANK	BNC	1250-0256	Specialty Connector 25-P118-1
J7 PEN LIFT	BNC	1250-0256	Specialty Connector 25-P118-1
J8 SWEEP OUT/IN (rear panel)	BNC	1250-0256	Specialty Connector 25-P118-1
J9 CNTR TRIG	BNC	1250-0256	Specialty Connector 25-P118-1
J10 STOP SWEEP	BNC	1250-0256	Specialty Connector 25-P118-1
J11 FM INPUT	BNC	1250-0256	Specialty Connector 25-P118-1
J12 AM INPUT	BNC	1250-0256	Specialty Connector 25-P118-1
J13 PROGRAMMING CONNECTOR	25-Pin D Series	1251-0063	ITT Cannon DBM-25P
J14 ALT SWP INTERFACE**	Audio 3-Pin Connector	no HP Part Number	Switchcraft TA-3F

*Refer to Figure 2-6 for HP-IB Interface Cable information. HP-IB Interface connector J4 signals and pin configuration are given in Figure 2-5.

** A 1219 mm (48") cable assembly with a Switchcraft TA-3F Audio 3-Pin connector on each end is supplied with the Model 8755C Swept Amplitude Analyzer as the Alternate Sweep Interface Cable. The complete cable may be ordered separately as HP Part Number 8120-3174.

2-31. Programming Connector

2-32. The Programming Connector J13 on the rear panel of the Model 8350A provides digital control of display functions and sweep oscillator Step Up control. Figure 2-7 gives a description of all pins and signals available on the Programming Connector. When the Model 8410B/8411A Network Analyzer is used with the Model 8350A, the Model 8410B Source Control Cable (HP Part Number 08410-60146) connects the Model 8410B rear panel SOURCE CONTROL and the Model 8350A rear panel PROGRAMMING CONNECTOR. Additionally, the sweep oscillator RF plug-in 1V/GHz output connects to the Model 8410B rear panel FREQ REF INPUT to insure that the Model 8410B phase locks with the sweep oscillator properly when sweeping octave or multi-octave bands. The Model 8410B Source Control Cable connector pins and signals are illustrated in Table 1-3 of this manual.

2-33. Operating Environment

2-34. Temperature. The instrument may be operated in temperatures from 0°C to +55°C.

2-35. Humidity. The instrument may be operated in environments with humidity from 5% to 80% relative at +25°C to +40°C. However, the instrument should also be protected from temperature extremes which cause condensation within the instrument.

2-36. Altitude. The instrument may be operated at altitudes up to 4572 meters (approximately 15,000 feet).

2-37. Cooling. Clearances for ventilation should be at least 10 cm (4 inches) at the rear of the cabinet and 7.6 cm (3 inches) at the sides. The clearances provided by the plastic feet in bench stacking and the filler strips in rack mounting are adequate for the top and bottom cabinet surfaces. A diagram illustrating the path for cooling airflow generated by the rear panel fan is given in Figure 2-8. Insure that the air intake and exhaust venting holes are not obstructed within the limits shown in Figure 2-8.

2-38. RF Plug-in Installation

2-39. To operate as a completely functional sweep oscillator, the Model 8350A Sweep Oscil-

lator must have an RF plug-in unit installed. To install an HP 86200 Series RF plug-in (coupled to a Model 11869A RF Plug-in Adapter) in the Model 8350A, refer to Section II, Installation, in the Model 11869A Operating and Service Manual. To install an HP 83500 Series RF plug-in unit into the Model 8350A mainframe:

- a. Set the Model 8350A mainframe LINE switch to OFF.
- b. Remove all connectors and accessories from the front and rear panel connectors to prevent them from being damaged.
- c. Position the RF plug-in unit latching handle in the fully raised position. The latching handle should spring easily into the raised position and be held by spring tension.
- d. Insure that the mainframe RF plug-in channel is clear, align the RF unit in the channel and slide it carefully into place towards the rear of the channel. It should slide easily without binding.
- e. The drawer latch handle slot will engage with the locking pin just before the RF plug-in is fully seated in position.
- f. Press the latch handle downward, while still pushing in on the RF plug-in, until the drawer latch is fully closed and the front panel of the RF plug-in is aligned with the mainframe front panel.

2-40. Bench Operation

2-41. The instrument cabinet has plastic feet and a foldaway tilt stand for convenience in bench operation. The tilt stand inclines the instrument for ease of operating the front panel controls and to allow the RF plug-in to be removed easier. The plastic feet provide clearance for air circulation and make the instrument self-aligning when stacked on other Hewlett-Packard full rack-width modular instruments. The instrument is packaged at the factory with two shipping bars attached to the front sides (refer to Figure 2-12). If the instrument does not include front handle or rack mount options, replace the shipping bars with the self-adhesive trim strips supplied with the instrument.

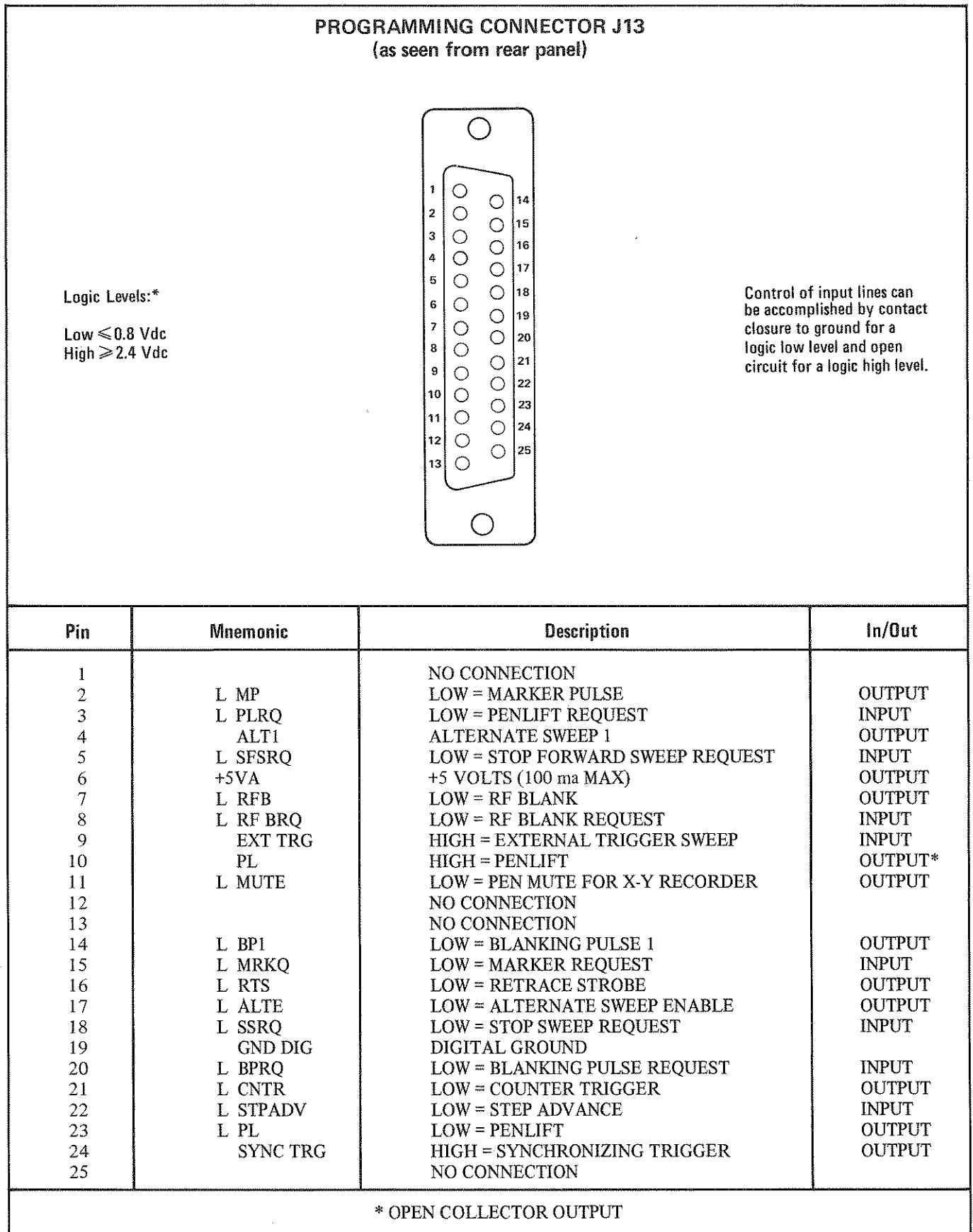

Figure 2-7. Programming Connector Signals and Pin Configuration

2-42. Front Handles (Option 907)

CAUTION

When installing front handles and rack mount kits, insure that the correct screws, specified in the installation figures in this section of the manual, are used. Use of a screw which is longer than the specified length may result in damage to internal components located behind the screw mounting holes in the instrument.

2-43. Instruments with Option 907 contain a Front Handle Kit. This kit supplies the necessary hardware and installation instructions for mounting two front handles on the instrument. Installation instructions are also given in Figure 2-9.

Additional Option 907 Kits may be ordered as HP Part Number 5061-0089.

2-44. Rack Mounting (Option 908)

2-45. Instruments with Option 908 contain a Rack Mount Kit. This kit supplies the necessary hardware and installation instructions for preparing the instrument to mount on an equipment rack with 482.6 mm (19 in.) support spacing. Installation instructions are also given in Figure 2-10. Additional Option 908 Kits may be ordered as HP Part Number 5061-0077.

2-46. Rack Mounting with Front Handles (Option 909)

2-47. Instruments with Option 909 contain a

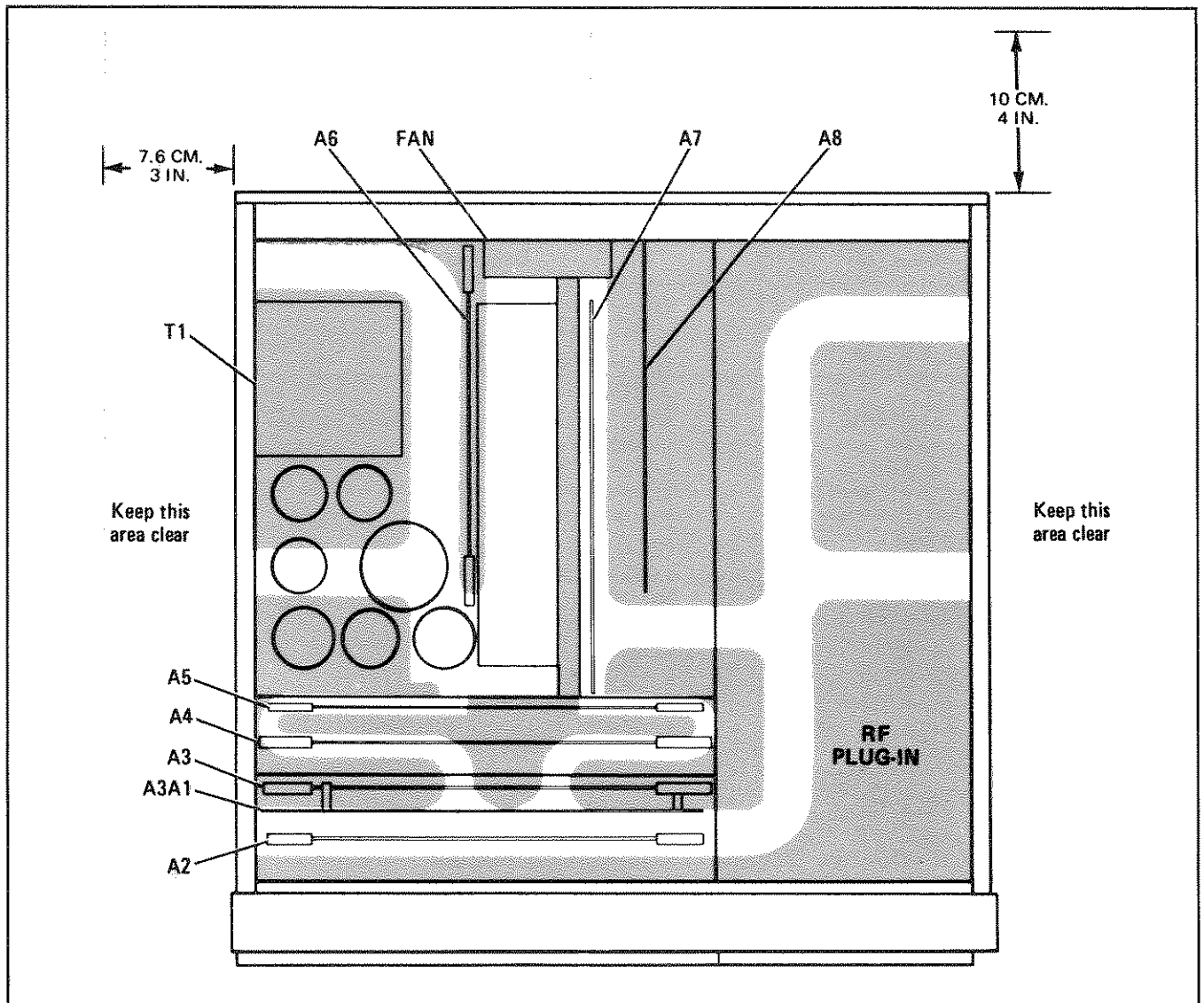
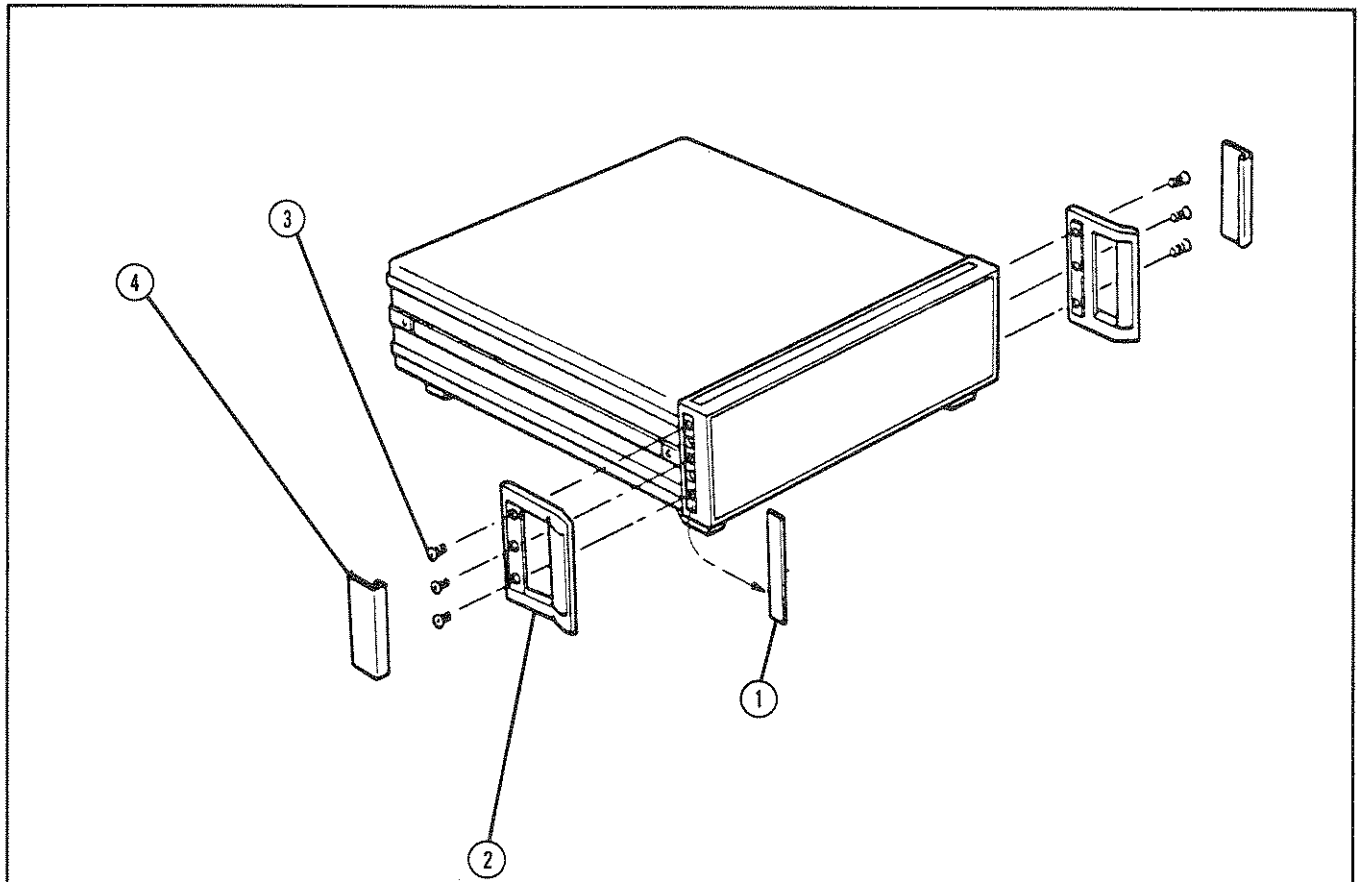

Figure 2-8. Model 8350A Ventilation Clearances and Airflow



INSTALLATION INSTRUCTIONS:

1. REMOVE SIDE TRIM STRIPS ①.
2. ATTACH FRONT HANDLE ASSEMBLY ② WITH THREE 8-32 x 3/8 SCREWS ③ PER SIDE.
3. PRESS FRONT HANDLE TRIM ④ IN PLACE.

OPTION 907 (HP Part No. 5060-0089) CONTENTS

Item	Qty.	HP Part No.	C D	Description
2	2	5060-9899	6	Front Handle Assembly
3	6	2510-0195	9	#8-32 x 3/8 Screw
4	2	5020-8896	7	Front Handle Trim

Figure 2-9. Option 907 Front Handles Kit

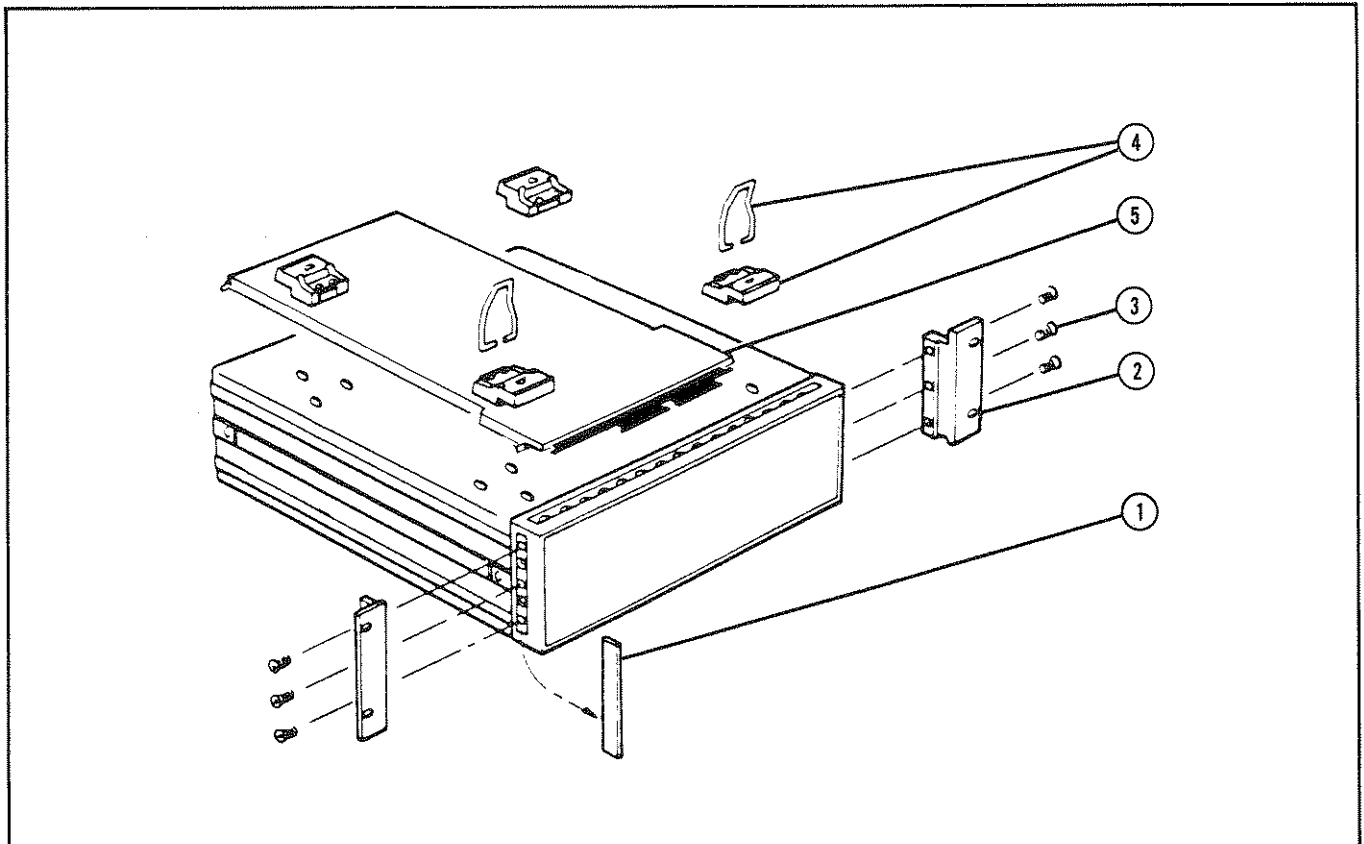

INSTALLATION INSTRUCTIONS:

1. REMOVE SIDE TRIM STRIPS ① .
2. ATTACH RACK MOUNT FLANGE ② WITH 8-32 x 3/8 SCREWS ③ .
3. REMOVE FEET AND TILT STANDS ④ BEFORE RACK MOUNTING. THIS ALSO REMOVES INFORMATION CARD TRAY ⑤ . TO RETAIN USE OF INFORMATION CARDS, DO NOT REMOVE FEET, AND WHEN RACK MOUNTING, ALLOW APPROXIMATELY 2CM (3/4 INCH) BELOW INSTRUMENT TO ACCOMODATE THE TRAY. (NO FILLER STRIP IS PROVIDED.)

OPTION 908 (HP Part No. 5061-0077) CONTENTS

Item	Qty.	HP Part No.	C D	Description
2	2	5020-8862	7	Rack Mount Flange
3	6	2510-0913	9	#8-32 x 3/8 Screw

Figure 2-10. Option 908 Rack Mount Kit

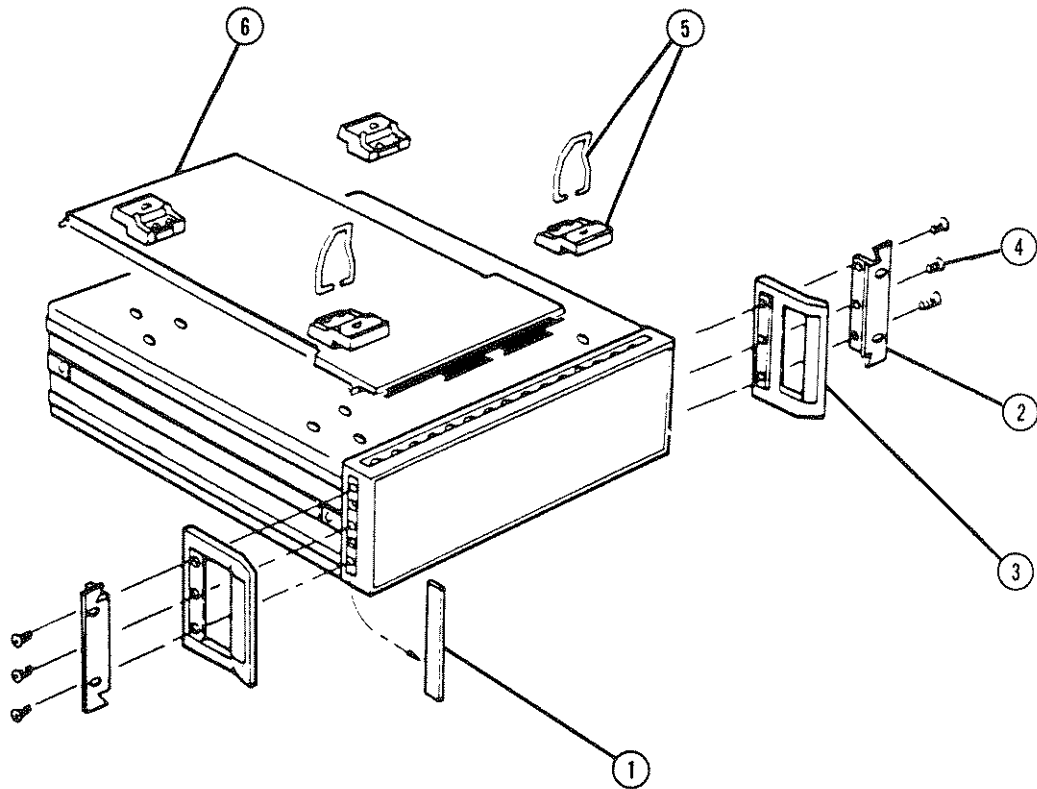

INSTALLATION INSTRUCTIONS:

1. REMOVE SIDE TRIM STRIPS ① .
2. ATTACH RACK MOUNT FLANGE ② AND FRONT HANDLE ASSEMBLY ③ WITH THREE 8-32 x 5/8 SCREWS ④ PER SIDE.
3. REMOVE FEET AND TILT STANDS ⑤ BEFORE RACK MOUNTING. THIS ALSO REMOVES INFORMATION CARD TRAY ⑥ . TO RETAIN USE OF INFORMATION CARDS, DO NOT REMOVE FEET, AND WHEN RACK MOUNTING, ALLOW APPROXIMATELY 2CM (3/4 INCH) BELOW INSTRUMENT TO ACCOMODATE THE TRAY. (NO FILLER STRIP IS PROVIDED.)

OPTION 909 (HP Part No. 5061-0083) CONTENTS

Item	Qty.	HP Part No.	C D	Description
2	2	5020-8874	1	Rack Mount Flange
3	2	5060-9899	6	Front Handle Assembly
4	6	2510-0194	8	#8-32 x 5/8 Screw

Figure 2-11. Option 909 Rack Mount Kit with Handles

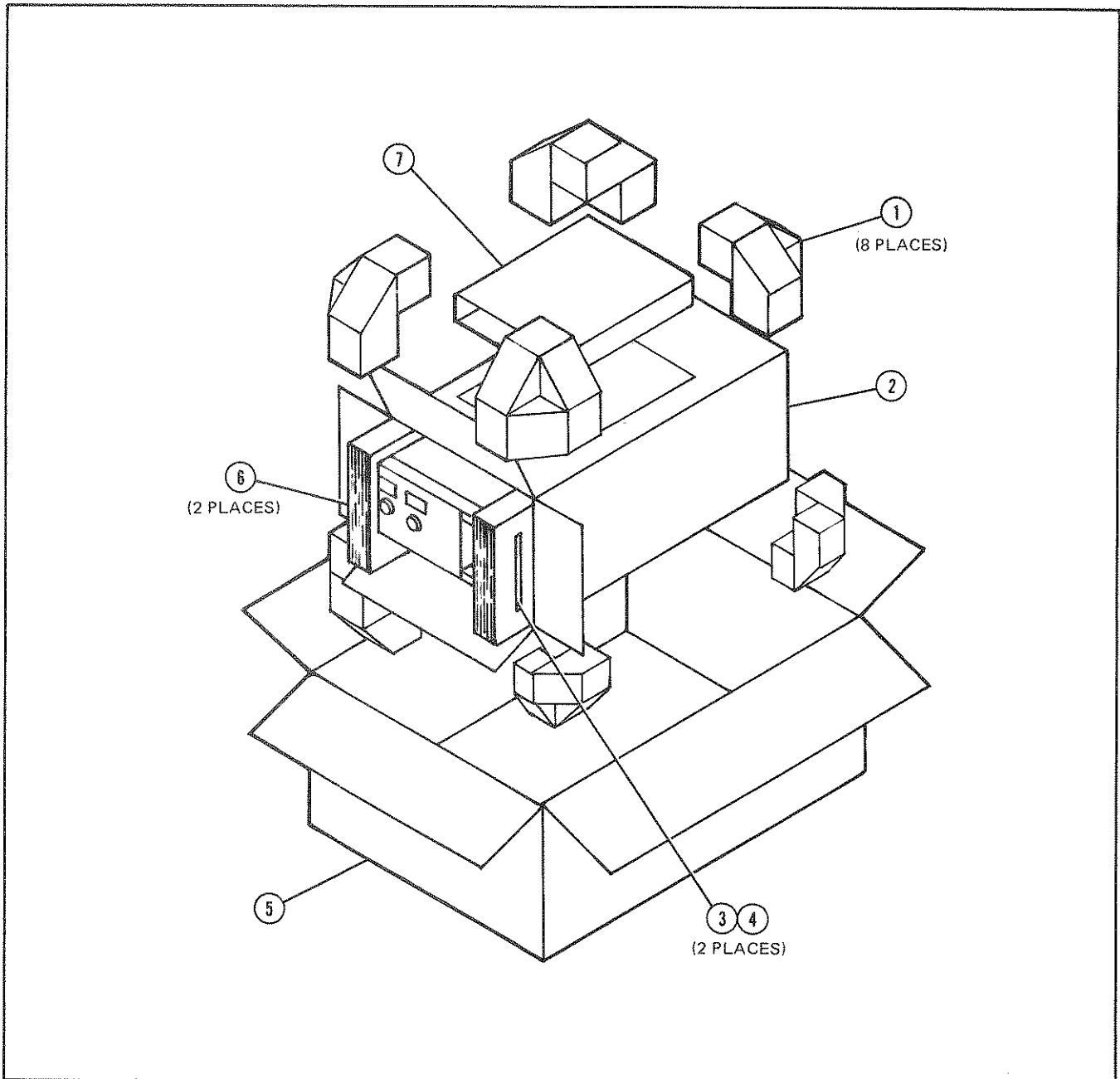

Item	Qty	HP Part No.	C D	Description
1	8	9220-2733	7	FOAM PADS - TOP CORNERS; BOTTOM CORNERS
2	1	9211-3462	2	CARTON - INNER
3	2	4040-1738	3	BARS - SHIPPING, NYLON
4	4	2510-0103	9	SCREW - FOR ATTACHING SHIPPING BARS
5	1	9211-3463	3	CARTON - OUTER
6	2	9220-3365	3	SIDE PADS - CORRUGATED CARDBOARD
7	1	9220-2950	0	SLEEVE - FOR MANUAL PROTECTION
8	1	9222-0484	5	POLY BAG - TO COVER INSTRUMENT (NOT SHOWN)

Figure 2-12. Packaging for Shipment using Factory Packaging Materials

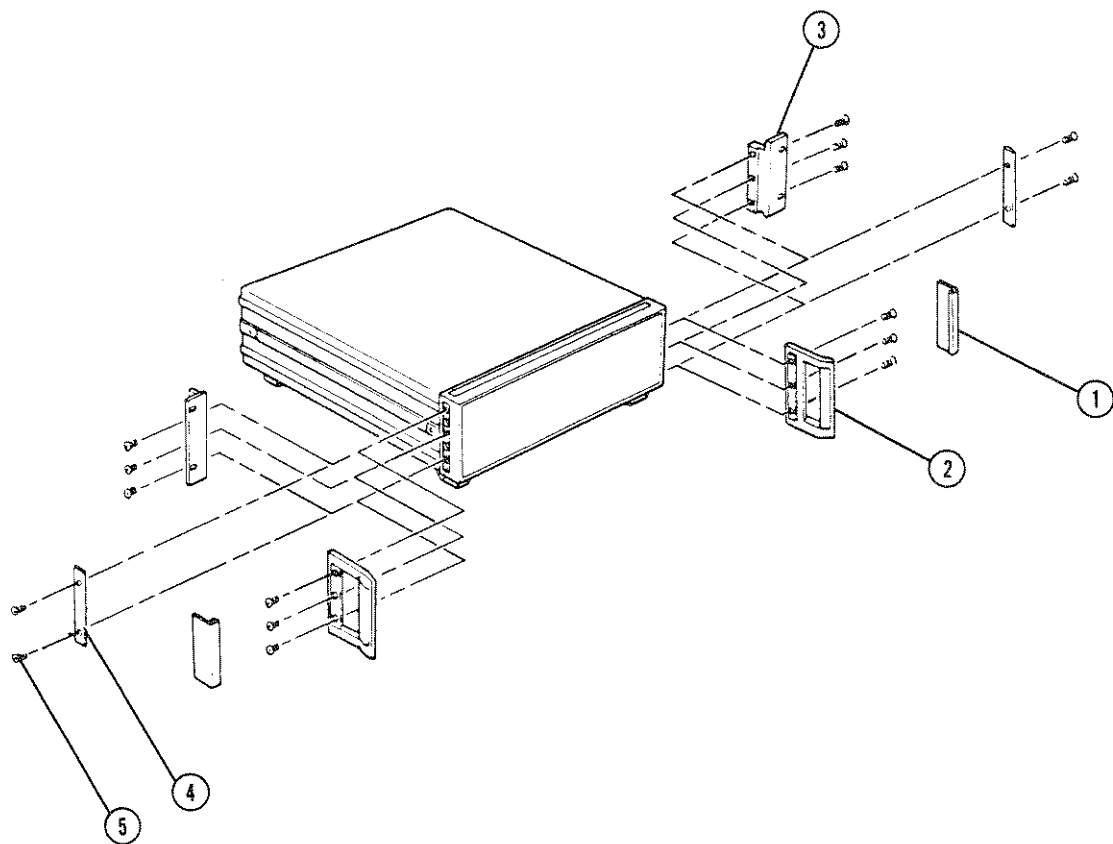

1. REMOVE RACK MOUNT FLANGE (3) AND/OR FRONT HANDLE ASSEMBLY, (1) (2).
2. ATTACH SHIPPING BARS* (4) WITH TWO 8-32 x 3/8 SCREWS (5).

*Refer to Figure 2-12 for Part Numbers of Shipping Bars and Screws.

Figure 2-13. Preparation of Instrument for Shipment

Rack Mount Kit with Front Handles, a combination of the Option 907 Kit and the Option 908 Kit. This kit supplies the necessary hardware and installation instructions for preparing the instrument to mount on equipment rack with 482.6 mm (19 in.) support spacing, with the addition of front handles. Installation instructions are also given in Figure 2-11. Additional Option 909 Kits may be ordered as HP Part Number 5061-0083.

Temperature..... -40°C to $+75^{\circ}\text{C}$
 Humidity.... 5% to 95% relative at 0°
 to $+40^{\circ}\text{C}$
 Altitude..... Up to 15240 meters
 (approximately 50,000 feet)

2-48. Battery Operation (Option 001)

2-49. Instruments with Option 001 contain a battery pack (inserted in the battery holder with a battery hold down clamp) and a modified A3 Microprocessor board. With Option 001 installed, the instrument has a nonvolatile memory which retains the contents of all instrument state storage registers, the current instrument state, and the HP-IB address. When shipped from the factory, the batteries are fully charged. The batteries will retain a sufficient charge to hold the memory contents for approximately 20 days from the date at which they were fully charged. The batteries are charged within the instrument, and a full charge is maintained at all times when the instrument LINE switch remains ON. The batteries do not charge when the instrument LINE switch is OFF. When fully discharged, the batteries will typically take approximately 33 hours to obtain a full charge. Allow the instrument to be on for at least 24 hours when new or when the instrument has been turned off for a sufficiently long enough period of time that the batteries might have become discharged to a level where memory contents may have been lost. Additional Option 001 Battery Kits may be ordered for the Model 8350A to upgrade a standard instrument to an Option 001 instrument by ordering HP Part Number 08350-60013. This Option 001 Battery Kit contains a battery pack, a battery pack hold down clamp, and a special A3 Microprocessor board. All other necessary wiring and hardware connections have been made at the factory on all standard instruments. Refer to Section VI Replaceable Parts in this manual for information and part numbers required to order individual battery packs.

2-50. STORAGE AND SHIPMENT

2-51. Environment

2-52. The instrument may be stored or shipped in environments within the following limits:

2-53. The instrument should also be protected from temperature extremes which may cause condensation in the instrument.

2-54. Packaging

2-55. **Original Packaging.** Containers and materials identical to those used in factory packaging are available through Hewlett-Packard offices. A complete diagram and listing of packaging materials used for the Model 8350A is shown in Figure 2-12. Prior to shipping in the factory packaging materials, the shipping bars should replace the front handles or rack mount flanges, as shown in Figure 2-13, to hold the instrument securely in the packaging material. If the instrument is being returned to Hewlett-Packard for servicing, attach a tag indicating the type of service required, return address, model number, and full serial number (located on rear panel serial plate). Mark the container FRAGILE to assure careful handling. In any correspondence, refer to the instrument by model number and full serial number.

2-56. **Other Packaging.** The following general instructions should be used for repackaging with commercially available packaging materials:

- Wrap the instrument in heavy paper or plastic. If shipping to a Hewlett-Packard Office or Service Center, attach a tag indicating the type of service required, return address, model number, and full serial number.
- Use a strong shipping container.
- Use enough shock-absorbing material around all sides of the instrument to provide a firm cushion and to prevent movement inside the container. Protect the control panel with cardboard.
- Seal the shipping container securely.
- Mark the shipping container FRAGILE to assure careful handling.
- In any correspondence, refer to the instrument by model number and full serial number.

SECTION III OPERATION

The Operation section of this manual consists of the following three subsections:

1. **OPERATING INFORMATION:** This subsection contains indexed functional blocks which provide complete (local and remote) information on the use of the 8350A Sweep Oscillator by function. Also contained in this subsection is Operator's Maintenance, Local, and Remote Operator's checks.
2. **LOCAL OPERATION:** This subsection provides Local (non-HP-IB) operating information arranged by function. This subsection also contains information on locally interfacing with the following test equipment:
 - HP 8755S Frequency Response Test Set
 - HP 8410B Network Analyzer
 - HP 7010B and other X-Y Recorders
 - HP 5343A Frequency Counter
3. **PROGRAMMING NOTES:** Programming Notes are individual publications documenting

the HP-IB use of the sweep oscillator. The following programming notes are included in this section:

- Introductory Operating Guide for use with the HP 9825A/B.
- Introductory Operating Guide for use with the HP 9835A.
- Introductory Operating Guide for use with the HP 9845A.
- Introductory Operating Guide for use with the HP 85A.
- Quick Reference Guide.

Contact your local sales office for copies of other Programming Notes as they become available.

This section also includes a blue service tag page. If sweep oscillator service is required, remove one of the tags and fill in as much information as possible. Attach this tag to the sweep oscillator to aid in servicing and reduce turn-around time.

8350A SWEEP OSCILLATOR

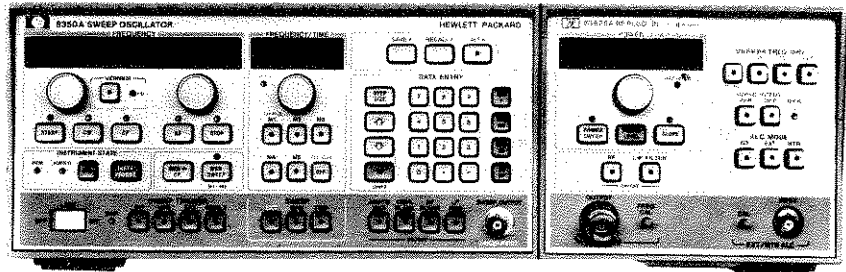

8350A SWEEP OSCILLATOR

© Copyright HEWLETT-PACKARD COMPANY 1980
1400 FOUNTAIN GROVE PARKWAY, SANTA ROSA, CALIFORNIA 95404

MANUAL PART NO. 08350-90001
Microfiche Part No. 08350-90002

Printed: AUGUST 1980



**HEWLETT
PACKARD**

SECTION III OPERATING INFORMATION

3-1. INTRODUCTION

3-2. This subsection contains a index of keys and functions which refer to the figured functional blocks at the end of this subsection. Included in this section are descriptions of all front panel controls connectors and indicators, operator's checks, operating instructions, and operator's maintenance.

3-3. SAFETY

3-4. Before applying power, refer to SAFETY CONSIDERATIONS in Section I of this manual.

3-5. The information, cautions, and warnings in this manual must be followed to ensure safe operation and to keep the instrument safe.

WARNING

Before the instrument is switched on, all protective earth terminals, extension cords, auto-transformers and devices connected to it should be connected to a protective earth grounded socket. Any interruption of the protective earth grounding will cause a potential shock hazard that could result in personal injury.

Only fuses with the required rated current and specified type should be used. Do not use repaired fuses or short circuited fuseholder. To do so could cause a shock or fire hazard.

CAUTION

Before the instrument is switched on, it must be set to the voltage of the power source, or damage to the instrument may result.

3-6. OPERATING CHARACTERISTICS

3-7. Table 3-1 briefly summarizes the major operating characteristics of the Sweep Oscillator. The table is not intended to be an in-depth listing of all operations and ranges. For more infor-

mation on Sweep Oscillator capabilities, refer to Specifications Table 1-1, and Supplemental Information Table 1-2.

3-8. Panel Features

3-9. Figure 3-1 Front Panel features provides a reference to a functional block figure number which provides a complete description of each control within the function block.

3-10. Rear Panel features are described in Figure 3-2.

3-11. OPERATOR'S CHECKS

3-12. The local operator's check (Figure 3-3) allows the operator to make a quick check of the main instrument functions prior to use. This check assumes that an RF plug-in is installed in the Sweep Oscillator and that a 10 dB attenuator, oscilloscope, and appropriate crystal detector are available. If these items are not available the preliminary self test may still be performed.

3-13. The remote operator's check (Figure 3-4) allows the operator to make a quick check to the main remote functions prior to use. This test is shown in program statements for HPL and BASIC and a general flow chart.

3-14. OPERATING INSTRUCTIONS

3-15. Located underneath the Sweep Oscillator is a pullout information card which contains information on general operating instructions, some remote programming information, and some plug-in usage information.

3-16. For a complete reference of each function refer to the function group index (Table 3-2).

3-17. LOCAL OPERATION

3-18. The operation of the 8350A Sweep oscillator in the Local mode is described in the Local Operation handbook and by functional block figures indexed in the table of contents and Table 3-2.

FRONT PANEL FEATURES

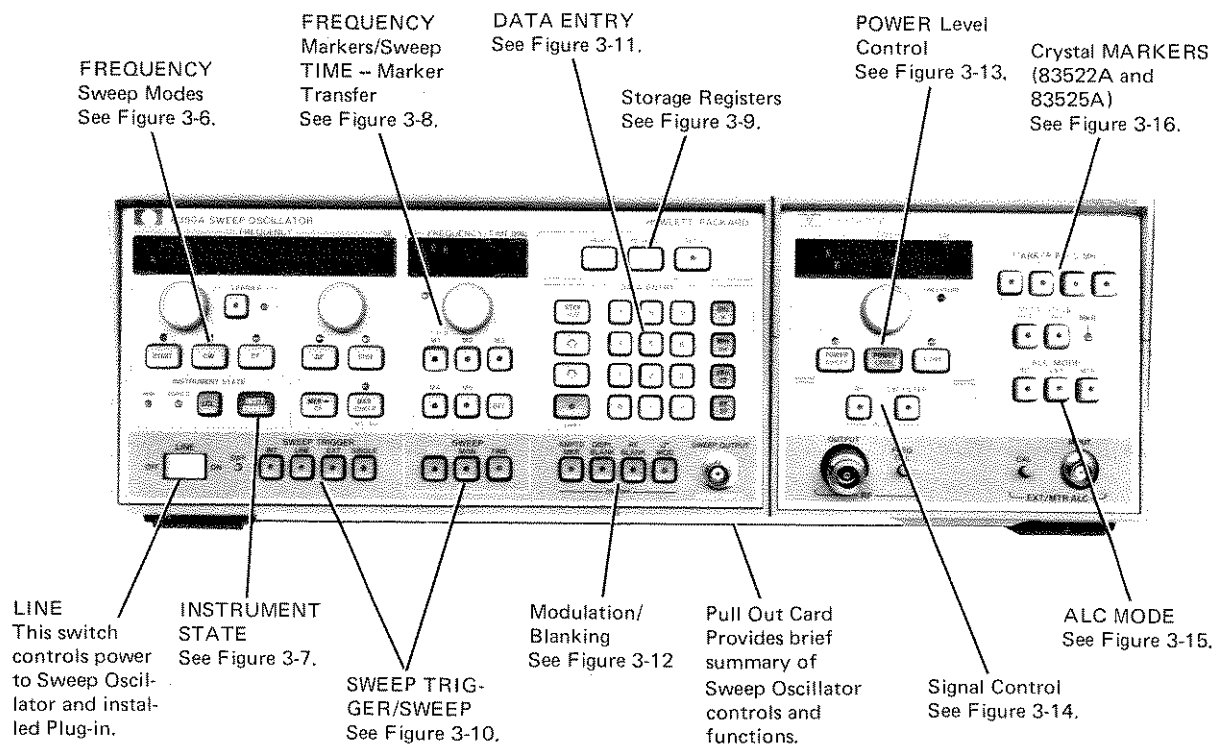
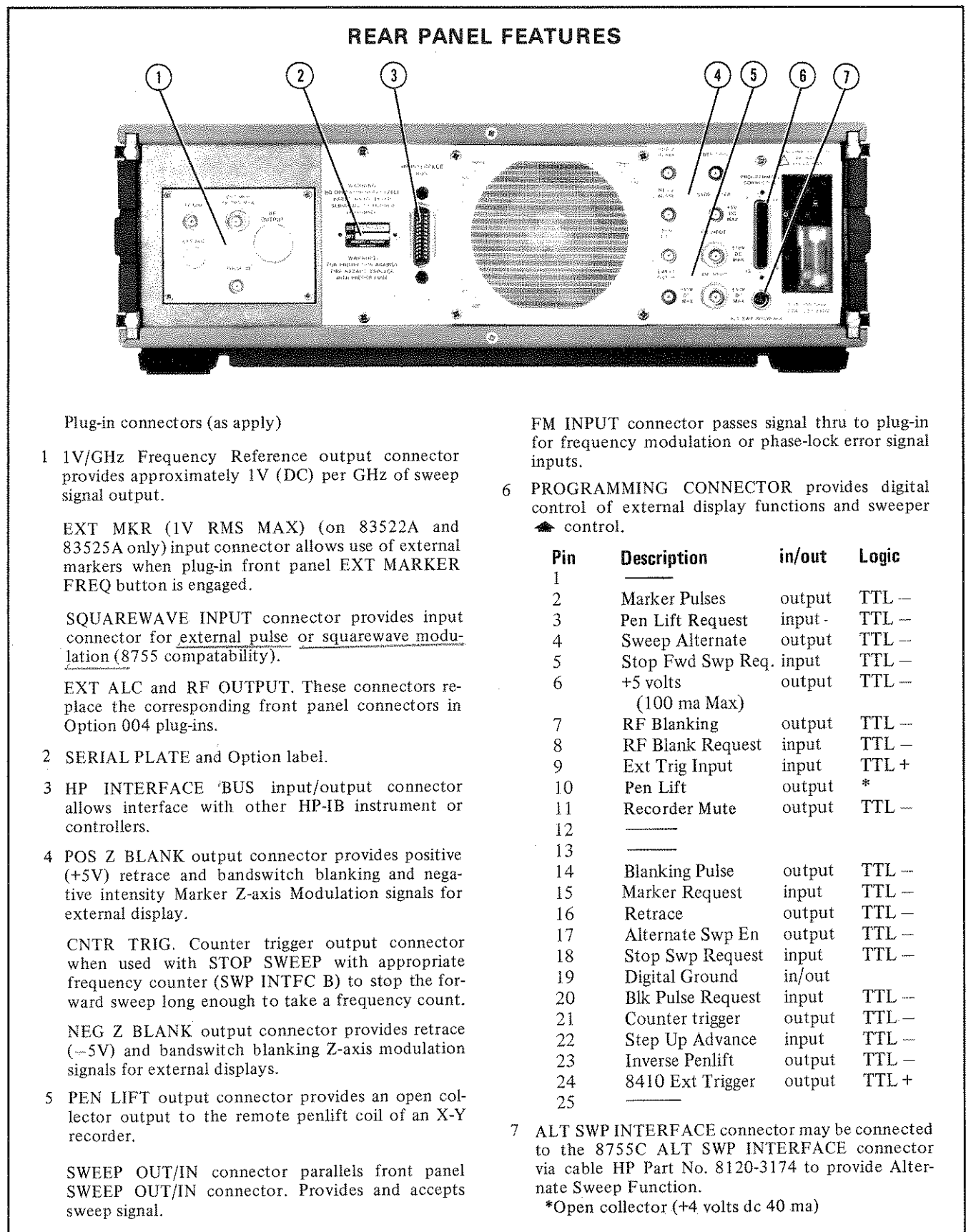

Figure 3-1. Front Panel Features



Plug-in connectors (as apply)

- 1 1V/GHz Frequency Reference output connector provides approximately 1V (DC) per GHz of sweep signal output.

EXT MKR (1V RMS MAX) (on 83522A and 83525A only) input connector allows use of external markers when plug-in front panel EXT MARKER FREQ button is engaged.

SQUAREWAVE INPUT connector provides input connector for external pulse or squarewave modulation (8755 compatibility).

EXT ALC and RF OUTPUT. These connectors replace the corresponding front panel connectors in Option 004 plug-ins.
- 2 SERIAL PLATE and Option label.
- 3 HP INTERFACE BUS input/output connector allows interface with other HP-IB instrument or controllers.
- 4 POS Z BLANK output connector provides positive (+5V) retrace and bandswitch blanking and negative intensity Marker Z-axis Modulation signals for external display.

CNTR TRIG. Counter trigger output connector when used with STOP SWEEP with appropriate frequency counter (SWP INTFC B) to stop the forward sweep long enough to take a frequency count.

NEG Z BLANK output connector provides retrace (-5V) and bandswitch blanking Z-axis modulation signals for external displays.
- 5 PEN LIFT output connector provides an open collector output to the remote penlift coil of an X-Y recorder.

SWEEP OUT/IN connector parallels front panel SWEEP OUT/IN connector. Provides and accepts sweep signal.

FM INPUT connector passes signal thru to plug-in for frequency modulation or phase-lock error signal inputs.

- 6 PROGRAMMING CONNECTOR provides digital control of external display functions and sweeper control.

Pin	Description	in/out	Logic
1			
2	Marker Pulses	output	TTL -
3	Pen Lift Request	input -	TTL -
4	Sweep Alternate	output	TTL -
5	Stop Fwd Swp Req.	input	TTL -
6	+5 volts	output	TTL -
	(100 ma Max)		
7	RF Blanking	output	TTL -
8	RF Blank Request	input	TTL -
9	Ext Trig Input	input	TTL +
10	Pen Lift	output	*
11	Recorder Mute	output	TTL -
12	—		
13	—		
14	Blanking Pulse	output	TTL -
15	Marker Request	input	TTL -
16	Retrace	output	TTL -
17	Alternate Swp En	output	TTL -
18	Stop Swp Request	input	TTL -
19	Digital Ground	in/out	
20	Blk Pulse Request	input	TTL -
21	Counter trigger	output	TTL -
22	Step Up Advance	input	TTL -
23	Inverse Penlift	output	TTL -
24	8410 Ext Trigger	output	TTL +
25	—		

- 7 ALT SWP INTERFACE connector may be connected to the 8755C ALT SWP INTERFACE connector via cable HP Part No. 8120-3174 to provide Alternate Sweep Function.
*Open collector (+4 volts dc 40 ma)

Figure 3-2. Rear Panel Features

Table 3-1. Sweep Oscillator Operating Characteristics

FREQUENCY RANGE	Set automatically when plug-in installed
SWEEP MODES	START-STOP CENTER FREQUENCY- Δ F Marker→Center frequency Marker Sweep CW Frequency
MARKERS	5 settable frequency markers amplitude and intensity
SWEEP TIME	Range .01–100 seconds
POWER	Control power level with 83500 Series Plug-ins

Table 3-2. Functional Block Index (1 of 2)

Function	Function Block Index	Page
ALC Mode	ALC Mode	41
ALL OFF	Frequency Markers	26
Alternate Sweep	Storage Registers	30
Amplitude Mkr Plug-in	Crystal Markers	43
Amplitude Markers 8350A	Modulation/Blanking	36
Back Space	Data Entry	34
Blanking Display	Modulation/Blanking	36
Modulation/Blanking RF	Modulation/Blanking	36
Center Frequency	Frequency Sweep Mode	21
Crystal Markers	Crystal Markers	43
CW Mode	Frequency Sweep Mode	21
CW Filter	Signal Control	40
Data Entry	Data Entry	34
dB—dBm	Data Entry	34
Delta Δ Frequency	Frequency Sweep Mode	21
Display Blanking	Modulation/Blanking	36
Down \blacktriangledown step	Data Entry	34
External ALC	ALC Mode	41
External Sweep	Sweep/Sweep Trigger	32
External Plug-in Markers	Crystal Markers	43
Frequency Sweep Modes	Frequency Sweep Mode	21
Frequency Markers 8350A	Frequency Markers	26
Frequency Markers Plug-in	Crystal Markers	43
GHz	Data Entry	34
HP-IB Only Functions	HP-IB Special Functions	45
Instrument Preset	Instrument State	24
Intensity Crystal Markers	Crystal Markers	43

Table 3-2. Functional Block Index (2 of 2)

Function	Function Block Index	Page
Intensity Markers 8350A	Frequency Markers.	26
Internal ALC	ALC Mode	41
Internal Sweep Trigger	Sweep/Sweep Trigger	32
Learn String	HP-IB Only Functions.	45
Level Power	Power Control	38
Line Sweep Trigger	Sweep/Sweep Trigger	32
Local key	Instrument State	24
Manual Sweep	Sweep/Sweep Trigger	32
M1 to M5	Frequency Markers.	26
Markers Crystal	Crystal Markers.	43
Marker Delta	Frequency Markers.	26
Marker Sweep	Frequency Markers.	26
Marker→Center Frequency	Frequency Markers.	26
Meter ALC	ALC Mode	41
Millisecond	Data Entry	34
MHz	Data Entry	34
Network Analyzer Trigger	HP-IB Only functions	45
Offset	Frequency Sweep Mode.	21
Output Active Parameter	HP-IB Only Functions.	45
Power Level	Power Control	38
Power Sweep	Power Control	38
Recall n	Storage Registers.	30
RF	Power Control	38
Save n	Storage Registers.	30
Shift	Data Entry	34
Single Sweep Trigger	Sweep/Sweep Trigger	32
Slope	Power Control	38
Slope Cal	Power Control	38
Square Wave \square Modulation	Blanking/Modulation.	36
Start Sweep	Frequency Sweep Mode.	21
Step Size	Data Entry	34
Stop Sweep	Frequency Sweep Mode.	21
Time Sweep	Frequency Markers.	26
UP \blacktriangle Step key	Data Entry	34
Vernier	Frequency Sweep Mode.	21

LOCAL OPERATOR'S CHECKS

DESCRIPTION

The Preliminary check provides assurance that most of the internal functions of the Sweep Oscillator are working. The main check provides a general check of the overall functions of the Sweep Oscillator.

PRELIMINARY CHECK

(Self test) Each time the Sweep Oscillator is turned on or INSTR PRESET button is engaged the instrument performs a series of self tests taking about one second to complete. When the self test is complete the instrument will be in the preset mode if a plug-in is installed or the left-most frequency display will have an E001 error code indicating no plug-in is installed. If error code E016 is observed refer to paragraph 3-103. If another error code is noted the Sweep Oscillator requires service refer to paragraph 3-107. Plug-in related error information (E050 to E059) is in the plug-in manual.

1. Set LINE switch to ON. Observe display in START/STOP mode with display frequency equaling plug-in range or E001 if no plug-in is installed.

MAIN CHECK

Equipment:

- RF Plug-in HP 83500 series or HP 86200 series with adapter HP 11869A (18 GHz or less)
- Oscilloscope..... HP 1220A or HP 1740A
- Crystal Detector HP 8473C or a crystal detector that will cover frequency range of interest.
- Attenuator 10 dB 8491B Option 010
- Cables BNC to BNC (3)..... 10503A (123 cm)

Setup:

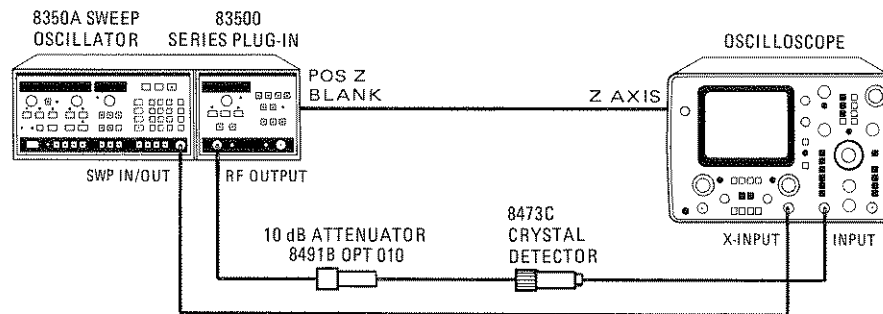

Connect the equipment listed above as shown in above diagram.

Figure 3-3. Local Operator's Check (1 of 2)

LOCAL OPERATOR'S CHECKS (Cont'd)**CAUTION**

BEFORE CONNECTING LINE POWER, ensure that all devices connected to this instrument are connected to the protective (earth) ground.

BEFORE SWITCHING ON THIS INSTRUMENT, ensure that the line power plug is connected to a three-conductor line power outlet that has a protective (earth) ground. (Grounding one conductor of a two-conductor outlet is not sufficient.)

NOTE

BEFORE SWITCHING ON THIS INSTRUMENT, ensure that the power transformer primary is matched to the available line voltage, the correct fuse is installed, and the safety precautions are taken. See *Power Requirements, Line Voltage Selection, Power Cables*, and associated warnings and cautions in Section II.

Procedure:



1. Set LINE switch to ON position. Observe that LEDs above START and STOP buttons are on with the frequency range of installed plug-in displayed above them. Oscilloscope trace should show detected RF signal output below zero-volt reference with no discontinuities in swept trace across band.
2. Press **CW** button. Observe LED above CW on and trace is reduced to dot at center of CRT with display at center of plug-in frequency range.
3. Press **CF** button. Observe LED above CF and ΔF buttons on, that displayed center frequency is at center of plug-in frequency range and ΔF display is equal to frequency span.
4. Press **MI** button. Observe button LED on and blinking and an intensity dot at approximately the center of the trace.
5. Press SWEEP **TIME** button then press DATA ENTRY  button a few times and observe sweep getting slower. Press DATA ENTRY  button a few times and observe sweep getting faster.
6. Press DATA ENTRY  **1** **GHz/s** and observe FREQUENCY/TIME display is 0.100 sec.

Figure 3-3. Local Operator's Check (2 of 2)

REMOTE OPERATOR'S CHECK			
Flowchart	HPL Statements ¹	BASIC Statements ²	Visual Indicators
<p>START</p> <p>--REMOTE</p> <p>Send REN command to ensure instrument is in remote enable state.</p> <p>--DATA</p> <p>Program sweep oscillator to Instrument Preset.</p> <p>Print Start and Stop frequencies.</p> <p>Switch to CW. Print CW.</p> <p>Switch to CF ΔF. Change sweep time to 10 seconds.</p> <p>--LOCAL</p> <p>Switch to local.</p>	<pre>rem 719 wrt 719,"IP" wrt 719,"OPFA" red 719,A wrt 719,"OPFB" red 719,B prt "START FREQ",A prt "STOP FREQ",B wrt 719,"CWOPCW" red 719,C prt "CW",C wrt,"CFST10SC," lcl 719</pre>	<pre>REMOTE 719 OUTPUT 719;"IP" OUTPUT 719;"OPFA" ENTER 719,A OUTPUT 719;"OPFB" ENTER 719,B PRINT "START FREQ";A PRINT "STOP FREQ";B OUTPUT 719;"CWOPCW" ENTER 719,C PRINT "CW";C OUTPUT 719;"CFST10SC" LOCAL 719</pre>	<p>Remote LED on</p> <p>Instrument START/STOP condition preset sweep</p> <p>Printout equals plug-in frequency range</p> <p>CW LED on printout CW frequency</p> <p>CF and ΔF, TIME LEDS on, 10 second sweep time</p> <p>Remote lamp out</p>
<p>1 Typical Statements for the HP 9825 Series Desktop Computer.</p> <p>2 Typical Statements for the HP 9835, 9845, and 85 Series Desktop Computers.</p>			

Figure 3-4. Remote Operator's Check

3-19. REMOTE OPERATION: HEWLETT-PACKARD INTERFACE BUS

3-20. The 8350A Sweep Oscillator can be operated remotely via the Hewlett-Packard Interface Bus (HP-IB). Bus compatibility, programming capability, and data formats are described in the following paragraphs. For complete information on specific program code syntax, functions, limits, etc., please see Functional Block Index Table 3-2.

3-21. All front panel functions except for the LINE switch and Set HP-IB Address are programmable through the HP-IB. Also provided are special HP-IB only functions to aid the programmer. Complete descriptions of all HP-IB programmable functions are contained within the functional blocks.

3-22. To verify that the Sweep Oscillator's HP-IB interface is functional, a quick check is provided in Figure 3-4 Remote Operators' Check. This tests that the 8350A can respond and send to the controller the fundamental HP-IB bus messages. The following information gives a general de-

scription of the HP-IB and defines the terms, concepts, and messages used in an HP-IB system.

3-23. For more information about the HP-IB, refer to any of the following documents:

IEEE Interface Standard 488-1975

ANSI Interface Standard MC1.1

"Improving Measurements in Engineering and Manufacturing" (HP Part No. 5952-0058)

"Condensed Description of the Hewlett-Packard Interface Bus" (HP Part No. 59401-90030)

3-24. General HP-IB Description

3-25. The HP-IB is a parallel bus of 16 active signal lines grouped into three sets according to function, to interconnect up to 15 instruments. Figure 3-5 is a diagram of the interface connections and bus structure. Table 3-3 defines the function of each signal line.

Table 3-3. The Bus Signals

Name	Nmemonic	Description
Data Input/Output	DIO1-8	The eight data lines for the byte of data.
Data Valid	DAV	Indicates the data lines have a valid byte of data.
Not Ready for Data	NRFD	Indicates that the listening devices are not ready to accept further data.
Not Data Accepted	NDAC	Indicates that the listening devices have not completely accepted the present byte of data.
Attention	ATN	Enables a device to interpret data on the bus as a controller command (command mode) or data transfer (data mode).
Interface Clear	IFC	Initializes the HP-IB system to an idle state (no activity on the bus).
Service Request	SRQ	Alerts the controller to a need for communication.
Remote Enable	REN	Places instruments under remote program control
End Or Identify	EOI	Indicates last data transmission during a data transfer sequence; used with ATN to poll devices for their status.

3-26. Eight signal lines form the first set and are termed "data" lines. The data lines carry coded messages which represent addresses, program data, measurements, and status bytes. The same data lines are used for input and output messages in bit-parallel, byte-serial form. Normally, a seven-bit ASCII code represents each piece (byte) of data, leaving the eighth bit available for parity checking.

3-27. Data transfer is controlled by means of an interlocked "handshake" technique which permits data transfer (asynchronously) at the rate of the slowest device participating in that particular conversation. The three data byte transfer control lines which implement the handshake (DAV, NRFD, NDAC) form the second set of lines.

3-28. The remaining five general interface management lines form the third set and are used in such ways as activating all the connected devices at once, clearing the interface, allowing a device to request service, etc.

3-29. Definition of HP-IB Terms and Concepts

3-30. The following list defines the terms and concepts that describe HP-IB system operations.

Byte: A unit of information consisting of 8 binary digits (bits).

Device: Any unit that is compatible with the IEEE Standard 488-1975.

Device Dependent: An action a device performs in response to information sent on the HP-IB. The action is characteristic of an individual devices' design and may vary from device to device.

Addressing: The set of characters sent by a controller to specify which device will send information on the bus and which device(s) will receive that information. A device may also have its address fixed so that it may receive information (listen only) or send information (talk only).

Polling: The process by which a controller can identify a device that needs interaction with it. The controller may poll devices for their operational condition one at a time, which is termed a serial poll, or as groups of devices simultaneously, which is termed a parallel poll.

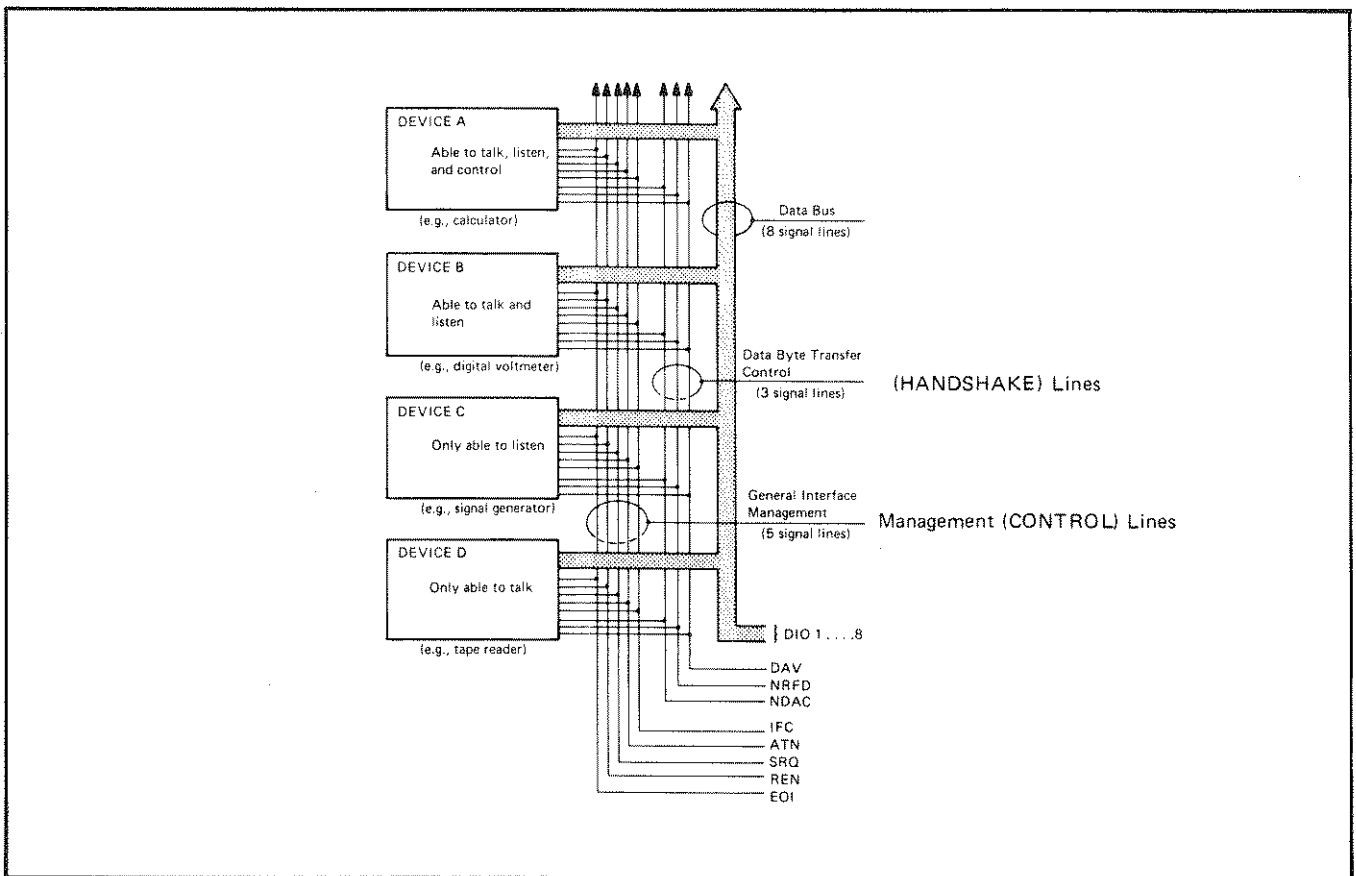

Figure 3-5. Interface Connections and Bus Structure

3-31. Basic Device Communication Capability

3-32. Devices which communicate along the interface bus fall into three basic categories.

Talkers: Devices which send information on the bus when they have been addressed.

Listeners: Devices which receive information sent on the bus when they have been addressed.

Controllers: Devices that can specify the talker and listener(s) for an information transfer. The controller can be an active controller or a system controller. The active controller is defined as the current controlling device on the bus. The system controller can take control of the bus even if it is not the active controller. Each system can have only one system controller, even if several controllers have system control capability.

3-33. HP-IB System Messages

3-34. The transfer of information via the HP-IB occurs from one device to one or more devices, thus consider the information to be a message. There are twelve types of messages on the HP-IB. The following describes each of the HP-IB System Messages.

- a. **The Data Message:** The actual information which is sent from the talker to one or more listeners on the HP-IB. The information or data can be numeric or a string of characters.
- b. **The Trigger Message:** This causes the listening device(s) to perform a device-dependent action when addressed.
- c. **The Clear Message:** This causes either the listening device(s) or all of the devices on the bus to return to a predefined device-dependent state.
- d. **The Remote Message:** This causes the listening device(s) to switch from local front panel control to remote program control when addressed to listen. This message remains in effect so that devices subsequently addressed to listen will go into remote operation.
- e. **The Local Message:** This clears the remote message from listening device(s) and returns the device(s) to local front panel control.
- f. **The Local Lockout Message:** This prevents the user of a device from manually inhibiting remote program control.
- g. **The Clear Lockout/Set Local Message:** This causes all devices on the bus to be removed from local lockout and revert to local. This message also clears the remote message for all devices on the bus.
- h. **The Require Service Message:** A device can send this message at any time to signify that the device needs some type of interaction with a controller. The message is cleared by sending the device's Status Byte message if the device no longer needs service.
- i. **The Status Byte Message:** A byte that represents the status of a single device on the bus. Within this byte, the seventh most significant bit (bit 6 of bits 0 through 7) indicates whether the device has sent a Require Service message. The remaining bits indicate the present operational conditions defined by the device. This byte is sent from a talking device in response to a serial poll operation performed by a controller.
- j. **The Status Bit Message:** A byte that represents the operational conditions of a group of devices on the bus. Each device responds on a particular bit of the byte thus identifying a device-dependent condition. This bit is typically sent by devices in response to a parallel poll operation by a controller.
- k. **The Pass Control Message:** This transfers the bus management responsibilities from the active controller to another controller.
- l. **The Abort Message:** The system controller sends this message to unconditionally assume control of the bus. This message terminates all bus communications but does not implement the Clear message.

This message can also be used by a controller to specify the particular bit and logic level that a device will respond with when a parallel poll operation is performed. Thus more than one device can respond on the same bit.

A summary of the twelve bus messages, their related commands and mnemonics are provided in Table 3-4.

Table 3-4. The Twelve Bus Messages (1 of 2)

HP-IB Message	Applicable	8350A Response	Related Comments	Interface Function	Message Type	Sample Statements	
						HPL (9825)	BASIC (9835,9845,85)
Data	Yes	Input data controls all front panel functions (except the Line switch) plus special HP-IB only functions. Output data includes information as to present instrument state, values of selected functions, and the instrument status.		T6 L4 AH1 SH1	Input Data	wrt 719; "..."	OUTPUT 719; "..."
					Output Data	red 719,A;...	ENTER 719;A,...
Trigger	Yes	Responds by triggering a sweep if and only if in the single sweep trigger mode.	GET	DT1	System Trigger	trg 7	TRIGGER 7
					Device Trigger	trg 719	TRIGGER 719
Clear	Yes	Clears the instrument status byte and the extended status byte.	DCL SDC	DC1	System Clear	clr 7	RESET 7
					Device Clear	clr 719	CLEAR 719
Remote	Yes	Removes the 8350A from local front panel control to remote HP-IB control. All functions remain the same as in local and the keyboard is non-responsive except the LOCAL key.	REN	RL1	System Remote	rem 7	REMOTE 7
					Device Remote	rem 719	REMOTE 719
Local	Yes	Removes the 8350A from remote HP-IB control to local front panel control. All functions remain the same as in the remote state.	GTL	RL1	System Local	lcl 7	LOCAL 7
					Device Local	lcl 719	LOCAL 719
Local Lockout	Yes	Functions the same as the remote message except that the entire front panel is disabled including the LOCAL key.	LLO	RL1		llo 7	LOCAL LOCKOUT 7
Clear Lockout/ Set Local	Yes	Removes the 8350A from local lockout and remote HP-IB control to local front panel control. All functions remain the same as in the remote state.	$\overline{\text{REN}}$	RL1		lcl 7	LOCAL 7
Require Service	Yes	The 8350A can set the HP-IB SRQ (Service Request) line if one of the following instrument conditions exists and has been enabled by the Request Mask value. Testable conditions include: parameter value altered, syntax error, end of sweep, power failure, and RF un-leveled.	SRQ	SR1		rds(719)→A, if bit (6,A) =1; gto "SRQ"	STATUS 719; A IF BIT (A,6)=1 THEN Srq

Table 3-4. The Twelve Bus Messages (2 of 2)

HP-IB Message	Applicable	8350A Response	Related Comments	Interface Function	Message Type	Sample Statements	
						HPL (9825)	BASIC (9835,9845,85)
Status Byte	Yes	Responds to a Serial Poll with one 8-bit byte with the seventh most significant bit (bit 6 of bits 0 through 7) set if the 8350A is Requesting Service. Bit 2 indicates a status change has occurred that can be detected only by analyzing the extended status byte which is accessible with the Output Status function only.	SPE SPD	T6		rds(719)→A	STATUS 719; A or A=S POLL (719)
Status Bit	No	The 8350A does not respond to a Paralell Poll.	PP0				
Pass Control	No	The 8350A does not have the ability to take or pass control of the HP-IB.	C0				
Abort	Yes	Responds by terminating all Listener or Talker functions.	IFC	T6 L4		cli 7	ABORT TO 7

3-35. HP-IB Addressing

3-36. Certain messages require that a specific talker and listener be designated. Each instrument on the bus has its own distinctive listen and/or talk address which distinguishes it from other devices. Devices can be listen only, talk only, and both talker and listener.

3-37. Addressing usually takes the form of “universal unlisten command, device talk address, device(s) listen address(es)”. The universal unlisten command removes all listeners from the bus, thereby allowing only the listener(s) designated by the device(s) listen address(es) to receive information. The information is sent by the talker designated by the talk address. The system controller may designate itself as either talker or listener.

3-38. Table 3-5 lists all the possible talk and listen addresses on the bus. The device address is

typically set via five binary bits which are the same for both listen and talk addresses, with the sixth and seventh bits used to determine when the address is listen (bits are 0,1) or talk (bits are 1,0). Some controllers distinguish between listen and talk automatically, requiring only the 5-bit code equivalent to designate a device.

3-39. 8350A HP-IB MESSAGE RESPONSES

3-40. The 8350A responds to the twelve bus messages as shown in Table 3-4.

3-41. 8350A HP-IB Compatibility.

3-42. Table 3-6 lists the 8350A Sweep Oscillators’ HP-IB capability, which are compatible with IEEE Standard 488-1975.

Table 3-5. Possible HP-IP Addresses

ASCII Listen Address	Characters Talk Address	Address Code (Binary)	Equivalent Decimal Value
		5 4 3 2 1	
SP	@	0 0 0 0 0	00
!	A	0 0 0 0 1	01
"	B	0 0 0 1 0	02
#	C	0 0 0 1 1	03
\$	D	0 0 1 0 0	04
%	E	0 0 1 0 1	05
&	F	0 0 1 1 0	06
'	G	0 0 1 1 1	07
(H	0 1 0 0 0	08
)	I	0 1 0 0 1	09
*	J	0 1 0 1 0	10
+	K	0 1 0 1 1	11
,	L	0 1 1 0 0	12
-	M	0 1 1 0 1	13
.	N	0 1 1 1 0	14
/	O	0 1 1 1 1	15
0	P	1 0 0 0 0	16
1	Q	1 0 0 0 1	17
2	R	1 0 0 1 0	18
3	S	1 0 0 1 1	19
4	T	1 0 1 0 0	20
5	U	1 0 1 0 1	21
6	V	1 0 1 1 0	22
7	W	1 0 1 1 1	23
8	X	1 1 0 0 0	24
9	Y	1 1 0 0 1	25
:	Z	1 1 0 1 0	26
;	[1 1 0 1 1	27
<	\	1 1 1 0 0	28
=]	1 1 1 0 1	29
>	↑	1 1 1 1 0	30

Table 3-6. 8350A Interface Functions

Code	Function
SH1	Source handshake capability
AH1	Acceptor handshake capability
T6	Basic talker; Serial Poll; Unaddress to talk if addressed to listen
L4	Basic listener; Unaddressed to listen if addressed to talk
SR1	Service Request capability
RL1	Remote; Local capability
PP0	No Parallel Poll capability
DC1	Device clear capability
DT1	Device trigger capability
C0	No controller capability
E1	Open collector bus drivers

3-43. Compatible Universal and Addressed HP-IB Commands.

3-44. The 8350A will respond to the following universal and addressed commands, which are sent in the command modes (ATN true).

Mnemonic	Command	ASCII Code
Universal:		
DCL	Device Clear	DC4
LLO	Local Lockout	DC1
MLA	My Listen Address	(selectable)
MTA	My Talk Address	(selectable)
SPD	Serial Poll Disable	EM
SPE	Serial Poll Enable	CAN
UNL	Unlisten	?
UNT	Untalk	-
Addressed:		
GET	Group Execute Trigger	BS
GTL	Go to Local	SOH
SDC	Selected Device Clear	EOT

3-45. Remote Mode.

3-46. Remote Capability. The 8350A communicates on the bus in both remote and local modes. In remote, its front panel controls are disabled except the LINE switch and LCL key. The 8350A can be addressed to listen or talk. When addressed to listen, the 8350A will automatically stop talking and respond to the following bus messages: Data, Trigger, Clear, Remote, Local, Local Lockout, Clear Lockout/Set Local, and Abort. When addressed to talk, the 8350A will automatically stop listening and send one of the following messages: Data, Require Service, or Status Byte.

3-47. Displays. The REM light is on when the 8350A is in the remote mode. The ADRS'D light is on when the 8350A is currently addressed to talk or listen. All other displays function the same as in local front panel control.

3-48. Local-to-Remote Change. The 8350A switches to remote upon receipt of the two part Remote message. The two parts of the Remote message are:

- Remote Enable (REN)
- Addressed to Listen (MLA)

3-49. The Sweep Oscillator's output signal and all control settings remain unchanged with the local-to-remote transition.

3-50. Local Mode.

3-51. Local Capability. In local, the 8350A can send a Require Service message, send a Status Byte, and respond to the Remote message.

NOTE

The 8350A can respond to all HP-IB messages except the Data Message while in local. However, most of these messages would not normally be used in the local mode.

3-52. Remote-to-Local Change. The 8350A returns to local control upon receipt of the Local or Clear Lockout/ Set Local message. It can also be set to local by pressing the front panel LCL key (assuming that local lockout is not in effect). The Sweep Oscillator's output signal and all control settings remain unchanged with the remote-to-local transition.

3-53. Local Lockout. When a data transmission is interrupted, which can happen by returning the 8350A to local with the front panel LCL key, the data could be lost. This would leave the 8350A in an unknown state. To prevent this, a local lockout is recommended to disable the LCL key. Local lockout remains in effect until the 8350A is returned to the local state by either turning the LINE switch off/on or by programming the Local Message.

3-54. 8350A Address Assignment Information.

3-55. The 8350A has a primary address that is determined by an internal storage register. The register is initialized upon power turn on by reading the address bits A5 through A1 from switches located on the 8350A A8 HP-IB Assembly. Note that these switches are factory preset to decimal 19 (Listen address of "3", Talk address of "S"). The 8350A HP-IB address can be dynamically changed from the front panel in local mode by executing the "Set HP-IB Address" function (Shift Local).

The present 8350A HP-IB address can be found by pressing the SHIFT followed by the LCL key.

3-56. The decimal equivalent of the talk/listen address will be displayed in the FREQUENCY/TIME display. Refer to Table 3-5 for interpretation of the equivalent decimal value into separate talk and listen address characters. To change the address refer to Figure 3-7 "Instrument State" for further information.

3-57. Receiving The Data Message

3-58. The 8350A accepts program codes that contain information for programming all of the front panel and special HP-IB only functions (except the LINE switch). The 8350A will respond to the Data message when in remote and addressed to listen.

3-59. Input Syntax. The 8350A responds to program codes in a Data message in the order in which they are received. Each function is programmed with a string of ASCII coded characters that follow one of the following sequences:

```
[Function Code] [Numeric Value] [Units Terminator] [EOS]
[Function Code] [Numeric Value] [EOS]
[Function Code] [EOS]
```

3-60. Function Codes. Function codes are typically 2 to 4 character mnemonics. For functions that have a numeric value associated with it, passing the function code only will enable and activate the function for further data entry.

3-61. Numeric Value. These are either a single decimal digit, a set of 14 characters or less representing a number, or a string of binary bytes. If the numeric value is a single digit (0 through 9), it represents a storage register. A string of 14 characters maximum can be expressed in exponential, decimal, or integer form. Acceptable numeric formats are referenced in further sections by the following format syntax:

Exponential	±d***d.d***E±dd
Decimal	±d***d.d***d
Integer	±d***d
Single Digit	d
Binary String	b***b
Binary Byte	b

Where the character 'd' indicates a leading or trailing zero, a space, or a numeric digit (0 through 9). The Characters "****" indicate a variable number of the previous characters. The character 'b' indicates an 8-bit binary byte. Numeric values that are not binary in nature are scaled by the appropriate units terminator.

3-62. Units Terminator. These are 2 character codes that terminate and scale the associated numeric value. Frequency values can be entered in GHz, MHz, kHz, or Hz. Sweep time values can be entered in Seconds or milliseconds. Power values can be entered in dBm or dB. If a units terminator is not passed, the 8350A assumes the numeric value is in the fundamental units of Hz or Seconds.

3-63. End Of String Message (EOS). This can be the ASCII character Line Feed (LF, decimal 10), the bus END command (EOI and ATN true), or another function code string.

NOTE

The HP-IB program code syntax typically mirrors that of the local front panel keystroke sequence.

3-64. Valid Characters. The alpha program codes can be either upper or lower case since the 8350A can accept either type. Spaces, unnecessary signs (+, -), leading zeroes, and carriage returns (CR) are ignored.

3-65. Program Codes. See Table 3-7 for the summary of input programming codes that are acceptable via the Data message.

3-66. Sending The Data Message.

3-67. The 8350A can send Data messages when in remote and addressed to talk. The available output modes are:

- Learn String
- Micro Learn String
- Mode String
- Interrogate Function
- Active Function
- Status

3-68. Each function is activated by the 8350A receiving a Data message with the appropriate function code (refer to Table 3-7). The Learn String, Micro Learn String, Mode String, and Status functions send a Data message consisting of a string of 8-bit binary bytes terminated using the bus END command (EOI and ATN true) with the last byte. The Interrogate and Active functions send a Data message consisting of a 14 character ASCII string representing the numeric value and terminated with a Carriage Return/Line Feed (CR/LF).

3-69. Binary Syntax. [b***b] [EOI]

3-70. Numeric Syntax. [\pm d.dddddE \pm dd][CR][LF]

3-71. The character 'b' indicates an 8-bit binary byte and 'd' indicates a decimal digit (0 through 9). The Characters '***' indicate a variable number of the previous characters. Note that the binary output format could have bytes that could be misinterpreted as Carriage Returns and/or Line Feeds so the user should defeat the ASCII CR/LF as a valid character string terminator.

3-72. Receiving The Trigger Message.

3-73. The 8350A responds to the Group Execute Trigger (GET) command to the HP-IB bus select code and a Selective Device Trigger to the 8350A HP-IB address. The effect of the GET command is to trigger the sweep if presently in the External Sweep Trigger mode only, otherwise no action is taken. The response is as if a Data message consisting of the Single Sweep Trigger (T4) program code were transmitted.

3-74. Receiving The Clear Message

3-75. The 8350A responds to both Device Clear (DCL) and Selective Device Clear (SDC) by resetting all HP-IB handshake lines to the inactive state. The effect is to remove the 8350A from any Talker or Listener control functions. The 8350A responds by clearing the Status Byte and the Extended Status Byte.

3-76. Receiving The Remote Message.

3-77. The Remote message causes the 8350A to switch to remote mode. It has two parts: 1) remote enable and 2) address-to-listen. The Sweep Oscillator's output and all other controls do not change with the local-to-remote transition.

3-78. The REM light turns on only when the 8350A is in remote mode and after receiving its first Data Message. The ADRS'D light turns on when the 8350A is addressed to talk or listen.

3-79. Receiving The Local Message.

3-80. The 8350A returns to front panel control when it receives the Local message. Its output and all other controls do not change with the remote-to-local transition.

3-81. When the 8350A goes to local mode, the front panel REM indicator turns off. However, the ADRS'D indicator would still illuminate if the 8350A were addressed.

3-82. The local message is the means by which the controller sends the Go To Local (GTL) bus command. The front panel LCL key can also return the 8350A to local mode. However, pressing the LCL key might interrupt a Data message to the 8350A and this would leave the 8350A in a state unknown to the controller. This situation could be avoided by sending the Local Lockout message which disables the LCL key.

3-83. Receiving The Local Lockout Message.

3-84. After receiving the Local Lockout message, the 8350A front panel LCL key is disabled in addition to all the other front panel keys. With local lockout in effect, the 8350A can be returned to local only by the controller or by turning the 8350A front panel LINE switch off/on.

3-85. Receiving The Clear Lockout/Set Local Message.

3-86. The 8350A responds to the Clear Lockout/Set Local message in the same way as to the Local message. Hence it returns to local front panel control. The 8350A need not be addressed to listen to receive this message.

3-87. Sending The Request Service Message.

3-88. The 8350A sends a Request Service message (RQS) whenever one of the following conditions exist and if it has been preprogrammed

Table 3-7. HP-IB Program Codes

Code	Description	Code	Description
AKm	Amplitude Marker On/Off	MPm	Marker 1-2 Sweep On/Off
ALmn	Alternate Sweep On/Off	MS	Milliseconds
A1	Internal Leveling	MZ	MHz
A2	External Crystal Leveling	M0	Marker Off
A3	External Power Meter Leveling	M1	Marker #1
BK	Backspace	M2	Marker #2
CAm	Amplitude Crystal Marker On/Off (83522/83525 Only)	M3	Marker #3
CF	Center Frequency	M4	Marker #4
Clm	Intensity Crystal Marker On/Off (83522/83525 Only)	M5	Marker #5
CW	CW Frequency	NT	Network Analyzer Trigger (8410B)
C1	1 MHz Crystal Marker Frequency (83522/83525 Only)	OA	Output Active Parameter
C2	10 MHz Crystal Marker Frequency (83522/83525 Only)	OL	Output Learn String
C3	50 MHz Crystal Marker Frequency (83522/83525 Only)	OM	Output Mode String
C4	External Crystal Marker Frequency (83522/83525 Only)	OP	Output Interrogated Parameter
DF	Delta F Frequency Span	OS	Output Status bytes
DM	dBm	OX	Output Micro Learn String
DN	Step Down/Decrement	PL	Power Level
DPm	Display Blanking On/Off	PSm	Power Sweep On/Off
DUm	Display Update On/Off	RCn	Recall Register
E	Exponent Power Of 10	RFm	RF Power On/Off
FA	Start Frequency	RM	Service Request Mask
FB	Stop Frequency	RPm	RF Blanking On/Off
Flm	CW Filter In/Out	RS	Reset Sweep
F1	-20 MHz/V FM	SC	Seconds
F2	-6 MHz/V FM	SF	Frequency Step Size
GZ	GHz	SH	Shift Function
HZ	Hz	SLm	Slope On/Off
IL	Input Learn String	SM	Manual Sweep
IP	Instrument Preset	SP	Power Step Size
IX	Input Micro Learn String	SS	Step Size
KZ	KHz	ST	Sweep Time
MC	Marker To Center Frequency	SVn	Save Register
MDm	Square Wave Amplitude Modulation On/Off	SX	external Sweep
MO	Marker Off	TS	Take Sweep
		T1	Internal Sweep Trigger
		T2	Line Sweep Trigger
		T3	External Sweep Trigger
		T4	Single Sweep
		UP	Step Up/Increment
		VR	CW Vernier
		0-9 + -	Acceptable Numeric Data

NOTES

1. Program codes of the form "XXm" use "m" to turn the function On or Off (1 or 0). For the storage register functions the "n" is 1 through 9.
2. The 8350A ignores spaces, plus signs, negative signs (except when valid) and any unexpected characters. Program codes can be upper or lower case alpha characters.

to send the message by the Service Request Mask (RM) function:

- Error in syntax
- Parameter value modified to default value
- Hardware failure
- End of sweep

3-89. The 8350A can send a Require Service message in either the local or remote mode. Further information pertaining to the instrument state can be obtained by conducting a Serial Poll or by executing the Output Status function, both of which access Status Byte information. The RQS state and the bus SRQ line are cleared only by executing a Serial Poll.

3-90. Sending The Status Byte Message.

3-91. After receiving a Serial Poll Enable command (SPE) and when addressed to talk, the 8350A responds by sending its Status Byte message as indicated in Table 3-8. A second status byte is available but must be accessed via the Output Status function. When the seventh most significant bit (bit 6, Request Service) of the Status Byte is true (one), an SRQ has occurred. See Service Request for the conditions causing a Service Request. Bit 4 indicates whether a change has occurred in the Extended Status Byte. If Bit 4 is

true, then the second status byte should be accessed via the Output Status function to determine the cause of the status change. All other bits indicate the present status of the noted function. The bits are true (one) if and only if the associated function/condition is true. To select an SRQ for a particular set of circumstances, both Status Bytes can be masked with the Service Request Mask function. The mask for each byte is determined by summing the decimal values of each selected function/condition that is desired. The default Service Request Mask Value is '00000000', or decimal 0. See Table 3-8 for decimal values of each Status Byte bit.

3-92. Sending The Status Bit Message.

3-93. The 8350A does not respond to the Parallel Poll Enable (PPE) bus command and thus cannot send a Status Bit message.

3-94. Receiving The Pass Control Message.

3-95. The 8350A does not have the ability to take or pass control thus it cannot respond to the Pass Control message.

3-96. Receiving The Abort Message.

3-97. The 8350A responds to the Abort message (IFC true) by stopping all Talker or Listener functions.

Table 3-8. Status Byte Information

STATUS BYTE (#1)								
BIT #	7	6	5	4	3	2	1	0
DECIMAL VALUE	128	64	32	16	8	4	2	1
FUNCTION	N/A	REQUEST SERVICE (RQS)	SRQ on Syntax Error	SRQ on End of Sweep	N/A	SRQ on Change in Extended Status Byte	N/A	SRQ on Numeric Parameter Altered to Default Value

EXTENDED STATUS BYTE (#2)								
BIT #	7	6	5	4	3	2	1	0
DECIMAL VALUE	128	64	32	16	8	4	2	1
FUNCTION	Airflow Failure	*RF Unleveled	Power Failure/on	N/A	N/A	N/A	N/A	Self Test Failed

*Bit/Functions not usable with 86200 Series Plug-ins and 11869A Adapter.

3-98. OPERATOR'S MAINTENANCE

3-99. Operator's maintenance consists of replacing defective fuses, cleaning the air filter, and cleaning the plug-in interface connectors. These items are discussed in the following paragraphs.

3-100. Fuses

3-101. There are twelve fuses in the 8350A. Only the ac line fuse located at the back of the instrument may be replaced by the Operator. The value for the ac fuse is printed on the rear panel of the instrument below the power module. The value and HP part number for the ac fuse may be found in Sections II (Installation) and IV (Replaceable Parts).

WARNING

For continued protection against fire hazard, replace only with 250 V fuses of the same current rating and type (normal blow).

3-102. To replace the ac fuse the Line switch should be switched off then the ac line cord removed from the power source and instrument. With the line cord removed, access may be gained to the fuse compartment. The fuse may be removed by pulling the lever inside the fuse compartment. The internal fuses should only be replaced by a qualified service technician.

WARNING

It is important that the following maintenance procedures be executed to retain the safety features which have been designed into the instrument.

3-103. Air Filter

3-104. The cooling fan located on the rear panel has a metal filter attached which will require periodic cleaning. Due to the variety of environmental conditions the interval between cleanings cannot be estimated. Error signal E016 indicates reduced air flow through an increase in temperature in the cooling system. When this error is noted on display a clogged filter may be the reason. To clean the filter refer to Section 8 of the manual.

3-105. Plug-in Interconnect

3-106. If plug-ins are changed frequently and/or the interconnectors are dirty the 8350A plug-in interconnect connector may require cleaning to avoid voltage losses (tune voltage).

3-107. Service Tag Information

3-108. If the Sweep Oscillator requires service and the operators maintenance is not sufficient the instrument may be sent as per Section 2 to your local HP service organization. Before sending the instrument back, fill out and attach one of the blue service tags. If a sweep oscillator error code is noticed when a failure occurs, note that error code in the failure symptoms/special control settings section of the tag.

FREQUENCY Sweep Mode

DESCRIPTION

This function block contains the keys to select one of the three desired modes (START/STOP, CW, CF/ Δ F) or a modification of the mode (VERNIER, OFFSET). The two displays provide a visual display of the frequencies in the mode selected. The rotary control knobs provide a variable control to change the frequency of the function selected.

PANEL LAYOUT

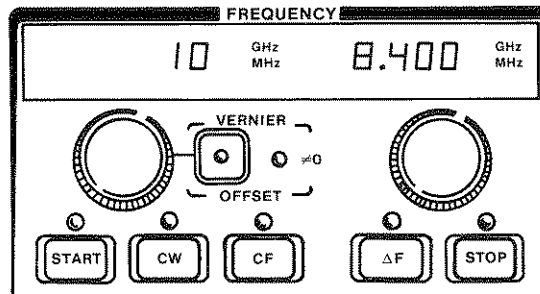

FUNCTIONS/INDICATORS

START: Enables START/STOP mode and allows selection of the lower frequency limit of sweep.

STOP: Enables START/STOP mode and allows selection of the upper frequency limit of sweep.

CW: Enables single frequency (CW) mode and allows selection of the frequency.

Swept CW: Enables CW mode with full SWEEP OUTPUT voltage (0-10 volts).

CF: Enables center frequency/delta frequency mode and allows selection of the center frequency.

Δ F: Enables center frequency/delta frequency mode and allows selection of the total frequency span.

VERNIER: Provides high resolution adjustments to values of the effective sweep center and CW frequencies. Range is 0.1 percent of plug-in frequency band.

OFFSET: Offset RF frequency by entered value. START/STOP, CF/ Δ F, and CW displays do not indicate the change. Light indicates non-zero OFFSET value.

$\neq 0$: This lamp indicates when a non-zero frequency vernier or offset value is in effect. To zero the vernier or offset, enter 0 MHz.

Figure 3-6. Frequency Sweep Mode (1 of 3)

LIMITATIONS/CONCERNS

1. The range of frequencies input to mainframe is determined by the plug-in (will accept values to $\pm 2\%$ out of range).
2. CW resolution equals 4096 points per band (includes $\pm 2\%$ overrange) except in VERNIER. Example; using a 2 to 8.4 GHz plug-in, 1.6 MHz is the resolution. The display range is 1 MHz to 99.99 GHz.
3. The order in which START/STOP or CF Δ F are entered is not important.
4. START frequency must be lower than STOP frequency. Entering a START frequency greater than the STOP frequency causes the STOP frequency to equal the START frequency. If the START frequency is greater than the STOP, then START equals the new STOP frequency.
5. Lights except as noted indicate active values/function.
6. Frequency values entered do not change when mode is changed.
7. Sweep Out provides a 0 to 10 volt ramp for all sweeps with 0 volts corresponding to the effective start frequency and 10 volts to the stop frequency. In CW mode the voltage out is equal to the percent of band (except swept CW).
8. Vernier value can "roll over" if knob or step causes the vernier value to exceed the maximum value then the CW/CF value is changed and the vernier value reset to 0 MHz (or appropriate value).

Figure 3-6. Frequency Sweep Mode (2 of 3)

LOCAL FUNCTION PROCEDURES:

Function	Activate	Data Forms				Range and Resolution
		On/Off	Knob	Step	Keyboard ¹	
Start Frequency	START		X	X	X	Range: See plug-in Resolution: ±0.24% of band
Stop Frequency	STOP		X	X	X	
Continuous Wave	CW		X	X	X	
Swept CW	SHIFT ΔF		X	X	X	
Center Frequency	CF		X	X	X	
Delta Frequency	ΔF		X	X	X	
Offset	SHIFT VERNIER		X	X	X	Range: ±0.05% of plug-in Resolution: ±.0008% of band
Vernier	VERNIER		X	X	X	

¹ Values must end with terminator (GHz or MHz).

REMOTE FUNCTION PROCEDURES:

Mode	Function	Program Code				
		Suffix	Scale	Resolution	Range	Resolution
START/STOP	Start	FA	Plug-in	±0.24%	GZ MZ KZ HZ	X10 ⁹ X10 ⁶ X10 ³ X1
	Stop	FB				
CW	CW	CW				
	Swept CW	SH CW				
CF/ΔF	Center Frequency	CF				
	Delta Frequency	DF				
OFFSET	Frequency Offset	SH VR				
VERNIER	Frequency Vernier	VR	±0.05% of band	±.0008%		

¹ Depends on plug-in used: 1KHz if <2 GHz in 83525 or 83522.

Figure 3-6. Frequency Sweep Mode (3 of 3)

INSTRUMENT STATE

DESCRIPTION

This function block contains two LEDs one that indicates whether Sweep Oscillator is in the remote mode, and another indicates when it is addressed to talk or listen. The local key when not in local lockout will switch the Sweep Oscillator from remote to local (front panel) control. The Instrument Preset key when engaged will first run the Sweep Oscillator self test then set the controls to the preset condition.

PANEL LAYOUT

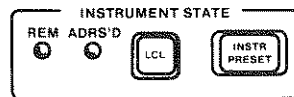

FUNCTIONS/INDICATORS

LCL: Returns Sweep Oscillator control to front panel from remote operation unless a Local Lockout has been executed. The 8350A retains the same control settings when switched from remote to local.

Select HP-IB Address: Provides a way to see and change the current HP-IP address code (0 to 30). The code is displayed in the FREQUENCY/TIME display.

INSTR PRESET: The following two steps take place when instrument preset is engaged or the sweep oscillator is switched on. Plug-in related error (E050 to E059) information is found in the plug-in manual.

1. A self test of the entire instrument is begun that takes approximately 1½ seconds to complete. If an error is found the test stops and an error code is displayed. Section 8 has a list of error codes and failures.
2. After self test the sweep oscillator presets the controls as follows:

SWEEP MODE: START/STOP, over the full frequency range of the plug-in

SWEEP TIME: fastest allowable for plug-in

Markers/Modulation: off, Marker frequency values reset to center of band

Vernier/Offset: 0 MHz

SAVE/RECALL: all registers set to INSTR PRESET value (if Opt. 001 Non-volatile memory, values unchanged)

When using 83500 series plug-ins:

POWER LEVEL: maximum leveled value

RF, CW Filter: on

ALC MODE: INT

CRYSTAL MARKERS: off (50MHz lamp on)

Figure 3-7. Instrument State (1 of 2)

REMOTE: Sets Sweep Oscillator into remote HP-IB operation.

LIMITATIONS/CONCERNS

1. Local key will not function if a Local Lockout has been implemented.
2. Allowable HP-IB addresses are from 0 thru 30. However the value 21 is typically reserved for the controller and should be avoided.
3. The HP-IB address set remains in effect until line power is turned off. At power turn on the internal HP-IB address switches are read and used as the address unless 8350A Option 001 is used. If Option 001 is used, the HP-IB address will remain unchanged.
4. If an instrument problem occurs Section 8 of the manual contains some operator initiated tests. These tests may isolate problems to enable service (via blue tag) to repair them faster.

LOCAL FUNCTION PROCEDURE:

Function	Activate	Data Forms				Range and Resolution
		On/Off	Knob	Step	Keyboard	
Local Key	LCL	X				
Select HP-IB Address	SHIFT LCL				X ¹	Integers from 0 to 30
Instrument Preset	INSTR PRESET	X				
Remote	Not Available					

¹ Address entered only after pressing the GHz, MHz, or dBm keys.

REMOTE FUNCTION PROCEDURE:

Mode	Function	Program Code				Resolution
		Prefix				
Local	Use HP - IB Command					
Select HP-IB Address	Not Available					
Instrument Preset	Instrument Preset	IP				
Remote	Use HP - IB Command					

Figure 3-7. Instrument State (2 of 2)

FREQUENCY Markers/Sweep TIME-Marker Transfer

DESCRIPTION

The frequency marker functions consist of up to five independent and continuously variable frequency markers. The Marker Δ function displays the difference frequency between any two markers. MKR \rightarrow CF sets the effective sweep center frequency (CF) equal to the active marker frequency. MARKER SWEEP initiates/exits sweep between Marker 1 and Marker 2. After exit, sweep returns to original sweep limits. The FREQUENCY/TIME display will display active marker frequency, Marker Δ frequency, Sweep Time, or frequency in manual sweep mode.

PANEL LAYOUT

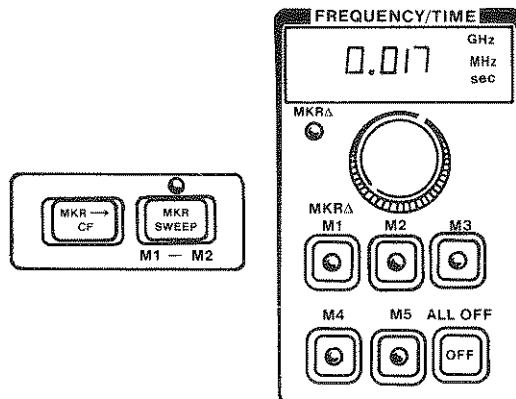

FUNCTIONS/INDICATORS

Markers 1 to 5: Each marker (M1 through M5) can be enabled and a frequency value defined. The last marker engaged is the active marker and it is the one modifiable by the control, step keys, keyboard, or remote control. Lamp off indicates marker off, lamp on, indicates marker on and lamp flickering indicates marker is active.

Active marker off: Turns off the active frequency marker and saves previous previous value. The value is recalled when marker is turned on later.

All Markers Off: Turns off all frequency markers saving the values of each to be recalled later when markers are turned on.

Marker Delta: Selects the MKR Δ mode where the FREQUENCY/TIME display indicates the frequency difference between the active frequency marker and the previously active frequency marker. The active marker is still active and modifiable via the FREQUENCY/TIME knob, step keys, keyboard or remotely. If in intensity marker mode the display trace is intensified between the two selected frequency markers.

Marker to Center Frequency: This function takes the value of the presently active frequency marker and reassigns it to the CW frequency, Center Frequency, or effective center frequency of the Start/Stop sweep. The frequency marker value is unchanged, the previous center frequency value is lost.

Figure 3-8. Frequency Markers/Sweep Time – Marker Transfer (1 of 4)

Marker Sweep: This function temporarily uses the values of Markers 1 and 2 and reassigns them to the Start and Stop frequencies respectively. The previous values of the Start and Stop frequencies are saved and reassigned when exiting Marker Sweep mode. If Marker 1 is greater than Marker 2 (or M2 less than M1) the lower frequency is used for the Start frequency, and the higher value for the Stop frequency. Note that the values of Markers 1 and 2 and hence the temporary Start and Stop frequency values can be modified in marker sweep mode by using either the start or the stop controls or M1 or M2 controls. The new values of M1 and M2 are retained upon exiting Marker Sweep mode.

Marker 1 to Start, Marker 2 to Stop: This functions the same as marker sweep except that the Start and Stop frequencies are permanently reassigned and not restorable to their previous values.

Counter Interface Enable and Disable: When Sweep Oscillator is used in swept mode this function enables the use of the 5343A Microwave Frequency Counter to count Start, Stop, or Marker frequencies.

LIMITATIONS/CONCERNS

1. All frequency markers are initialized to the value of the center frequency of the frequency range of the plug-in at power on.
2. Frequency markers if active and the present value is out of the present sweep frequency range, will be reassigned the value of the present effective center frequency when the FREQUENCY/ TIME knob is first turned.
3. If no markers are presently active when entering MKR Δ , Markers 1 and 2 are assumed the active and previously active markers respectively.
4. If Marker 1 frequency is higher than Marker 2 frequency then these values are permanently interchanged in Marker Sweep mode.
5. Start and Stop values are modified to correspond to the new center frequency and old sweep width in MKR \rightarrow CF. Likewise the Δ Frequency Span and Start/Stop may be modified so that the new frequency sweep is within the frequency range of the plug-in.
6. If no marker is presently active the previously active marker is assumed. At power on Marker 1 is assumed to be the active marker.
7. If Marker 1 and/or Marker 2 are not on when entering Marker Sweep mode, they are turned on and their previous values used. At power on, all markers are assigned the value of the effective center frequency of the plug-in frequency range.
8. If sweep width is out of range when MKR \rightarrow CF is engaged it will automatically scale down the Δ Frequency to be within plug-in frequency range.
9. The plug-in and markers have the capability of 2 percent frequency overrange, if this occurs a flickering of the GHz or MHz indicators will occur.

LOCAL FUNCTION PROCEDURE:

Function	Activate	Data Forms				Range and Resolution
		On/Off	Knob	Step	Keyboard ¹	
Markers	M1 to M5		X	X	X	
Marker Δ	SHIFT M1		X	X	X	
Marker to Center Frequency	MKR - CF		X	X	X	Range See plug-in Resolution: .024% of band
Marker Sweep	MKR SWEEP	X	X	X	X	
Permanent Marker Sweep	SHIFT MKR SWEEP		X	X	X	
Turn Off Active Marker	OFF	X				
Turn Off All Markers	SHIFT OFF	X				
Counter Interface Enable	[function] SHIFT M2	X				
Counter Interface Disable	SHIFT M3	X				

¹ Values must end with terminator (GHz or MHz).

Figure 3-8. Frequency Markers/Sweep Time - Marker Transfer (3 of 4)

REMOTE FUNCTION PROCEDURE:

Mode	Function	Program Code				
		Prefix	Range	Resolution	Suffix	Scale
Markers	Select and Position Markers	M1 to M5	Plug-in	.024%		
Δ Marker	Displays Difference Frequency	SH M1			GZ MZ KZ HZ	X10 ⁹ X10 ⁶ X10 ³ X ¹
MKR * CF	Active Marker To	MC				
MARKER SWEEP	Sweep ON M1 and M2 OFF	MP1 MP0				
MARKER SWEEP	Permanent Marker Sweep	SH MP				
OFF	Active Marker Off	M1 to M5			MO MO	
ALL OFF	All Markers Off	SH			MO MO	
Counter Interface Enable	Counting End Points or Marker On Swept Frequency	FA, FB, or M1 to M5 SH M2				
Counter Interface Disable	Disables Swept Counting	SH M3				

Figure 3-8. Frequency Markers/Sweep Time – Marker Transfer (4 of 4)

Storage Registers

DESCRIPTION

The Save n function allows all the control settings to be stored in one of the nine internal registers. The Recall n function will implement the previously stored settings. Alternate n function alternates between current state and register selected on successive sweeps.

PANEL LAYOUT



FUNCTIONS/INDICATORS

SAVE : Enables current settings (modes, frequencies etc.) to be stored in a register. Nine registers are available for storage (1 through 9).

RECALL: Enables a resetting of one of the nine stored register modes. When enabled the registers may be incremented with the UP control or decremented with the down control. Registers not previously stored will contain the instrument preset settings.

Alternate: Alternates between current state and selected stored register on successive sweeps. If used with appropriate HP 8755C, current state response is on channel 1 and selected state response is on channel 2.

LIMITATIONS/CONCERNS

1. Unused registers have instrument preset values stored until new new values are stored.
2. The instrument preset function sets all registers to instrument preset settings except in Option 001 instruments which retain stored settings even with AC power off.
3. Remote Step Up Advance (Programming Connector) or Auto Step allows cycling of storage registers.

Figure 3-9. Storage Registers (1 of 2)

LOCAL FUNCTION PROCEDURE:

Function	Activate	Data Forms				Range and Resolution
		On/Off	Knob	Step	Keyboard	
Store Settings	SAVEN				X	Integers 1 to 9
Recall Settings	RECALLn			X ¹	X	Integers 1 to 9
Alternate Sweep Settings	ALTn			X ¹	X	Integers 1 to 9
Alternate Sweep Off	ALTn	X			X	

¹ Step keys activated only after a number has been entered.

REMOTE FUNCTION PROCEDURE:

Mode	Function	Program Code				
		Prefix	Range	Resolution	Suffix	Scale
SAVE	Store Current Settings	SV	Register 1 to 9			
RECALL	Resets Stored Settings	RC	Register 1 to 9			
ALTERNATE	Successive Sweep Selected and Current	AL1	Register 1 to 9			
	Alternate Off	ALO				

Figure 3-9. Storage Registers (2 of 2)

SWEEP/SWEEP TRIGGER

DESCRIPTION

This function Block contains seven keys for control of sweep source and time. This block also has a SWP LED to indicate sweep in progress. The SWEEP type keys enable selection of EXT, MAN or TIME sweep controls. The SWEEP TRIGGER keys enable selection of INTernal, LINE, EXTernal and SINGLE sources of sweep triggering. Lights on keys indicate active function.

PANEL LAYOUT

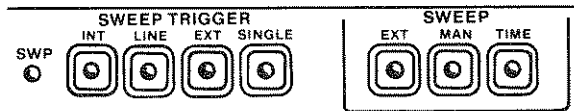

FUNCTIONS/INDICATORS

SWEEP EXTERNAL: Enables sweep input via front or rear panel SWP input BNC (SWP INPUT 0 to 10 volts) to externally tune plug-in oscillator.

SWEEP MANUAL: Enable manual control of sweep voltage via frequency inputs. Manual frequency is displayed on FREQUENCY/TIME display.

SWEEP TIME: Enables internally timed sweep. The triggering for TIME may be one of the following sweep trigger modes.

INT: Enables internal sweep triggering (free run, auto).

LINE: Enables triggering by power line frequency.

SWEEP TRIGGER EXT: Enables external triggering of sweep via rear panel auxiliary connector pin 9. A two volt trigger (20 volts max) must be supplied to auxiliary connector.

SINGLE: Selects and/or triggers or aborts single sweep.

LIMITATIONS/CONCERNS

1. SWEEP TRIGGER controls work only in TIME sweep mode.
2. Using the step keys with sweep time forces specific values in a 1,2,5 sequence such as 10ms, 20ms, 50ms, 100ms, etc. No step value can be set for sweep time.
3. When first engaged, single sweep is selected if in a different sweep trigger mode. If presently in single sweep, this triggers a new sweep.

Figure 3-10. Sweep/Sweep Trigger (1 of 2)

LOCAL FUNCTION PROCEDURE:

Function	Activate	Data Forms				Range and Resolution
		On/Off ³	Knob	Step	Keyboard ¹	
SWEEP TYPE External	EXT	X				
Manual	MAN		X	X	X	Range: Present Sweep Width Resolution: 0.01% of present sweep
Time	TIME		X	X ²	X	Range: 0.01 to 100 sec. ⁴ . Resolution: 0.001 sec.
SWEEP TRIGGER Internal	INT	X				
Line	LINE	X				
External Volts	EXT	X				2 to 5 Volts Input
Single Activates	SINGLE					Key and Triggers

¹ Values must end with terminator (GHz, MHz, S, or mS).

² The step size may not be set for time.

³ Each mode (except TIME) disables other modes.

⁴ The limit for broad band sweeps is higher than 0.01 second.

REMOTE FUNCTION PROCEDURE:

Mode	Function	Program Code				
		Prefix	Range	Resolution	Suffix	Scale
Sweep Type	External	SX				
	Manual	SM	Frequency		GZ MZ KZ HZ	X10 ⁹ X10 ⁶ X10 ³ X1
	Time	ST	0.01–100 second	0.001 second	SC MS	X1 second X10 ⁻³ seconds
Sweep Trigger	Internal	T1				
	Line	T2				
	External	T3				
	Single	T4				

Figure 3-10. Sweep/Sweep Trigger (2 of 2)

DATA ENTRY-Step Keys/Keyboard

DESCRIPTION

This function block contains the step key function, numeric entry keyboard and terminators which allow modification of many of the values of functions. This function block has a back key which works like an erase or rubout of the last entry. Also in this function block is a shift key (blue) which enables shift key functions.

PANEL LAYOUT

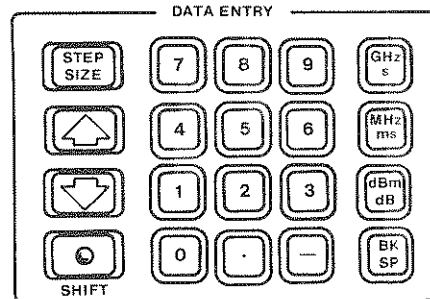

FUNCTIONS/INDICATORS

STEP SIZE: This function allows the setting of the frequency or power level step size.

▲ (step up): This function increments the presently active parameter value by the appropriate step size.

▼ (step down): This function decrements the presently active parameter value by the appropriate step size.

0-9, -, .: Numeric digits, sign, and decimal point useable to input data for active function.

BACK SPACE: This function performs a character back space, or rubout, to erase the last digit entered on the present numeric entry. Function enabled only when entering a number and units terminator have not been entered.

GHz/s: Units terminator for Gigahertz frequency data or seconds time data.

MHz/ms: Units terminator for Megahertz frequency data or millisecond time data.

dBm/dB: Units terminator for dbm or dB power data.

SHIFT (blue key): This function enables the "shift" functions that are labeled in blue on the front panel or required key code in remote HP-IB.

LIMITATIONS/CONCERNS

1. Step size not settable for sweep time. It is a 1,2,5 data progression like 10 msec, 20 msec, 50 msec, 100msec, etc.
2. No visible data display for step size values.
3. Step size entry is differentiated via units terminator (ie. frequency or power step).
4. All numeric entries are not input/entered until the appropriate units terminator is entered.
5. Auto Step via depressing up or down key causes the active parameter to be stepped as long as the key is depressed.
6. The dBm/dB key will be a default value of Hz or sec.

Figure 3-11. Data Entry- Step Keys/Keyboard (1 of 2)

7. Negative numeric data must be entered with negative sign first.
8. Blank and unnecessary negative signs are ignored by the sweep oscillator.
9. Some shift functions are not labeled on the front panel, References Shift Function section.
10. Shift key indicator on until a correct shift function key stroke is entered.
11. The default Step Size values are 0.1% of the present ΔF for frequency parameters, 1 dB for power parameters.

LOCAL FUNCTION PROCEDURE:

Function	Activate	Data Forms				Range and Resolution
		On/Off	Knob	Step	Keyboard	
STEP SIZE Frequency	(Frequency Parameter) STEP SIZE		X	X	X	Range: See plug-in frequency limits. Resolution: 1 MHz
STEP SIZE Power	(Power Parameter) STEP SIZE		X X	X X	X X	Range: See plug-in power limits Resolution: 0.01 dB
Reset to default STEP SIZE	SHIFT STEP SIZE	X				

REMOTE FUNCTION PROCEDURE:

Mode	Function	Program Code				
		Prefix	Range	Resolution	Suffix	Scale
STEP SIZE	Frequency Step Size	SF	See Plug-in Frequency Limits	1 MHz	GZ MZ KZ HZ	X10 ⁹ X10 ⁶ X10 ³ X1
	Power Step Size	SP	See Plug-in	0.1 dB	DM	
STEP INCREMENT	Step Up (▲)	UP				
STEP DECREMENT	Step Down (▼)	DN				
BACK SPACE	Back Space	BK				
Default STEP SIZE	Reset to default STEP SIZE	SH SS				

Figure 3-11. Data Entry – Step Keys/Keyboard (2 of 2)

Modulation/Blanking

DESCRIPTION

This function block controls the frequency marker display mode, RF power and external CRT control. Mainframe frequency markers can be RF amplitude dips or CRT intensity dots (via Z-axis control). The RF power can be turned off during the retrace sweep. The CRT display retrace sweep can be blanked. The internal squarewave amplitude modulation can be enabled. The squarewave frequency is 27.8 KHz standard for proper operation with the HP 8755 Frequency Response Test Set or internally selectable (see Section IV) for 1 KHz for proper operation with the HP 415 SWR Meter and other instruments. The sweep input/output connector is also in this block.

PANEL LAYOUT

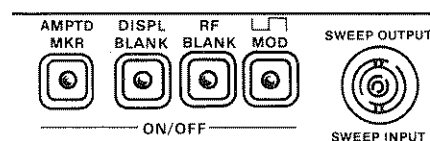

FUNCTIONS/INDICATORS

AMPLITUDE MARKER: This function when engaged (light on) sets the mainframe frequency markers into RF amplitude dips instead of CRT intensity dots (via Z-axis control).

DISPLAY BLANKING:- This function when engaged (light on) blanks the retrace sweep on CRT displays via Z-axis control.

RF BLANKING: This function when engaged (light on) blanks (turns off) the RF power during the retrace sweep.

□ SQUAREWAVE MODULATION: This function when engaged (light on) enables the internal amplitude modulation squarewave. The standard squarewave frequency is 27.8 KHz, internally selectable to 1 KHz.

SWEEP OUTPUT/INPUT: When Sweep Oscillator is in manual or time sweep mode this connector provides a linear ramp voltage from 0 to 10 volts that is synchronous with RF sweep. In external sweep mode connector is input for a sweep ramp from 1 to 10 volts.

LIMITATIONS/CONCERNS

1. Changing frequency of modulation (1 or 27.8 KHz) requires removal of a jumper (see Adjustment section).
2. Plug-in frequency markers are controlled from plug-in for CRT intensity dots or RF amplitude dips.

Figure 3-12. Modulation/Blanking (1 of 2)

3. Internal squarewave modulation and a External AM signal can be used simultaneously.
4. CRT Z-axis control is provided with both positive and negative polarity control for blanking (via rear panel POS Z-BLANK or NEG Z-BLANK). Mainframe frequency markers, when used in the CRT intensity dot mode are useable with positive polarity Z-axis control only.

LOCAL FUNCTION PROCEDURE:

Function	Activate	Data Forms				Range and Resolution
		On/Off	Knob	Step	Keyboard	
Amplitude Markers	AMPTD MKR	X				
Display Blanking	DSPL BLANK	X				
RF Blanking	RF BLANK	X				
Squarewave Modulation	□ MOD	X				

REMOTE FUNCTION PROCEDURE:

Mode	Function	Program Code				
		Prefix	Range	Resolution	Suffix	Scale
Amplitude Markers	Amplitude Marker On	AK1				
	Amplitude Marker Off	AK0				
Blanking	Display Blanking On	DP1				
	Display Blanking Off	DP0				
	RF Blanking On	RP1				
	RF Blanking Off	RP0				
Modulation	□ Modulation On	MD1				
	□ Modulation Off	MD0				

Figure 3-12. Modulation/Blanking (2 of 2)

POWER Control

DESCRIPTION

This function block contains all functions relating to the RF output power level. The desired power level can be set. To compensate for a linear loss through a device (like a cable) on the output of the plug-in, a slope compensation can be set to level the output. To provide a ramp of output power, a power sweep width can be set and the Power Sweep function enabled. Power Sweep starts the RF output power at the Power Level setting then ramps up the specific Power Sweep width.

PANEL LAYOUT

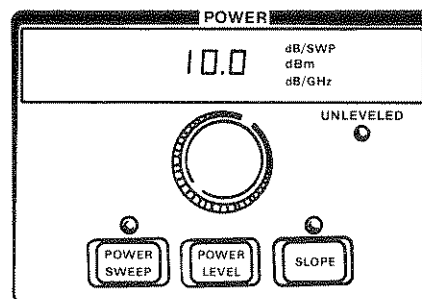

FUNCTIONS/INDICATORS

POWER LEVEL: This function when enabled (light on) allows setting of the output power level for all ALC modes. Calibrated power level in internal leveling mode only.

POWER SWEEP: This function when enabled (light on) allows setting of the power sweep width (in dB) for the power sweep function. Power Sweeps from Power Level to Power level plus Power Sweep width.

SLOPE: This function when engaged (light on) allows setting of the frequency slope compensation in dB/GHz. Allows compensation for lossy devices to achieve a flat, leveled output power at output of device/cable by increasing the output power at higher frequencies.

UNLEVELED Light: Light is on when all or portion of sweep is unleveled.

POWER Display: Provides digital display of Power Level and Power Sweep to a tenth of a dB and Slope to 0.01 dB. The units for power level are dBm, for power sweep dB, and for slope it is dB/GHz.

Figure 3-13. Power Control (83500 series Plug-ins) (1 of 2)

LIMITATIONS/CONCERNS

1. Power level control is calibrated over a 10 dB range, typically 15 dB. Power Level range up to 80 dB with plug-in Option 001 (70 dB Step Attenuator).
2. The total combined Slope and Power Sweep range is 15 dB.
3. Power Sweep will not cross a Step Attenuator boundary.
4. Power Sweep and Slope values may not be negative.

LOCAL FUNCTION PROCEDURE:

Function	Activate	Data Forms				Range and Resolution
		On/Off	Knob	Step	Keyboard ¹	
Power Level	POWER LEVEL		X	X	X	Range: See plug-in Resolution: 0.024 dB
Power Sweep	POWER SWEEP		X	X	X	
Slope	SLOPE		X	X	X	

¹ Values must end with terminator (dBm or dB).

REMOTE FUNCTION PROCEDURE:

Mode	Function	Program Code				
		Prefix	Range	Resolution	Suffix	Scale
Power	Level	PL	10-15 dB	0.01dBm	DM	X1 dBm X1 dB
Power	Sweep On	PS1	25.5 dB			
	Sweep Off	PS0				
	Slope On	SL1	5 dB/GHz			
Slope Off	SLO					

Figure 3-13. Power Control (83500 series Plug-ins) (2 of 2)

Signal Control

DESCRIPTION

This function block controls the signal purity and switches the signal RF off or on. The CW Filter, when enabled, reduces the oscillator tuning voltage noise and hence Residual FM. The CW Filter is inactive in sweep modes.

PANEL LAYOUT

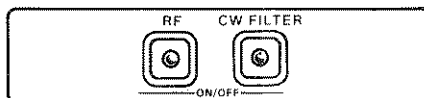

FUNCTIONS/INDICATORS

RF ON/OFF: This function switches RF power on (light on) or off (≥ 30 dB attenuation).

CW FILTER ON/OFF: This function enables (light on) or disables the oscillator tune voltage filter when in CW or manual sweep modes only.

LIMITATIONS/CONCERNS

1. CW filter not enabled during sweeps.

LOCAL FUNCTION PROCEDURE:

Function	Activate	Data Forms				Range and Resolution
		On/Off	Knob	Step	Keyboard	
RF Power	RF	X				
CW Filter	CW FILTER	X				

REMOTE FUNCTION PROCEDURE:

Mode	Function	Program Code				
		Prefix	Range	Resolution	Suffix	Scale
RF	Power On	RF1				
	Power Off	RF0				
CW Filter	Filter On	FI1				
	Filter Off	FI0				

Figure 3-14. Signal Control (83500 series plug-ins)

ALC MODE

DESCRIPTION

This functional block controls all Automatic Leveling Control (ALC) functions of the output power. Several modes of ALC can be selected, these are Internal, External via a Crystal/Detector, or external via a Power Meter.

PANEL LAYOUT

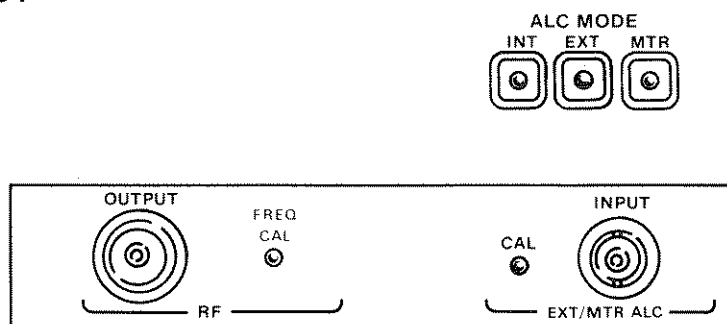

FUNCTIONS/INDICATORS

INTERNAL ALC: This selects the internal crystal detector/coupler for leveling the output power at the front panel output connector.

EXTERNAL ALC: This selects the external crystal detector for leveling with the detector output applied to the front panel External ALC BNC input connector.

METER ALC: This selects the external power meter for leveling with the power meter output applied to the front panel External ALC input connector.

EXT/MTR/ALC INPUT: Input connector for External crystal detector and power meter outputs.

ALC CAL: Used to adjust external leveling gain when using EXTERNAL leveling. Clockwise rotation increases gain.

FREQUENCY CAL: Adjustment that allows calibrating the RF plug-in frequency using the crystal markers, frequency marker indicator, and a CW or Start Frequency value.

LIMITATIONS/ CONCERNS

1. Only crystal detectors of negative polarity (-10 to -150 millivolts) can be used.
2. Only power meter outputs of 0 to 1 volts can be used. The HP 431 and 432 series are compatible, the HP 435 and 436 are not.

Figure 3-15. ALC Mode (83500 series plug-ins) (1 of 2)

LOCAL FUNCTION PROCEDURE:

Function	Activate	Data Forms				Range and Resolution
		On/Off ¹	Knob	Step	Keyboard	
Internal Leveling	INT	X				
External Leveling	EXT	X				
Power Meter Leveling	MTR	X				

¹ Each mode disables all other appropriate modes.

REMOTE FUNCTION PROCEDURE:

Mode	Function	Program Code				
		Prefix ¹	Range	Resolution	Suffix	Scale
ALC Leveling	INTERNAL	A1				
	External Crystal	A2				
	External Power Meter	A3				

¹ Mode disables all other possible modes.

FREQUENCY MARKER INDICATOR: Lamp lites when RF output frequency is coincident with the selected crystal marker frequency.

Figure 3-15. ALC Mode (83500 series plug-ins) (2 of 2)

Crystal MARKER FREQUENCY

DESCRIPTION

This functional block controls the crystal frequency markers by selection of the marker crystal frequency and the marker display mode (intensity or amplitude). Crystal frequency combs of 1 MHz (usable below 1 GHz), 10 MHz, 50 MHz, or an external frequency may be input to the rear panel External Marker input. The crystal frequency markers can be displayed independent of the mainframe frequency markers in their CRT intensity dot (via Z-axis control) and/or RF amplitude dips.

PANEL LAYOUT

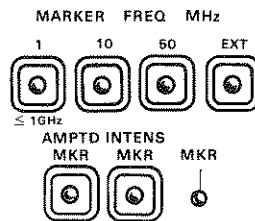

FUNCTIONS/INDICATORS

1 MHz CRYSTAL: Selects (light on) a crystal frequency comb of markers at harmonics of 1 MHz.

10 MHz CRYSTAL: Selects (light on) a crystal frequency comb of markers at harmonics of 10 MHz.

50 MHz CRYSTAL: Selects (light on) a crystal frequency comb of markers at harmonics of 50 MHz.

EXTERNAL FREQUENCY: Selects frequency markers at the RF frequencies that are input to the rear panel External Marker input to the rear panel External Marker input. Allowable RF power range at input is -10 dBm minimum to $+10$ dBm maximum.

INTENSITY MARKER: Sets the marker display mode to CRT intensity dots via Z-axis control.

AMPLITUDE MARKER: Sets the marker display mode to RF amplitude dips.

EXTERNAL MARKER INPUT: Rear panel input for external frequency marker. Maximum drive range -10 to $+10$ dBm.

Figure 3-16. Crystal Marker Frequency (83500 series plug-ins) (1 of 2)

LIMITATIONS/CONCERNS

1. Plug-in markers display modes are independent of the 8350A mainframe markers. Hence any combination of intensity or amplitude markers will work.
2. Intensity markers obtainable using the positive polarity Z-axis output only.
3. Maximum drive level of External Marker Input is +10 dBm.
4. Plug-in markers can be intensity and amplitude variety simultaneously.

LOCAL FUNCTION PROCEDURE:

Function	Activate	Data Forms				Range and Resolution
		On/Off	Knob	Step	Keyboard	
1 MHz Marker	1	X				
10 MHz Marker	10	X				
50 MHz Marker	50	X				
External	EXT	X				
Amplitude Markers	AMPTD MKR	X				
Intensity Markers	INTENS MKR	X				

REMOTE FUNCTION PROCEDURE:

Mode	Function	Program Code				
		Prefix	Range	Resolution	Suffix	Scale
Crystal Marker Frequency	1 MHz ¹	C1				
	10 MHz ¹	C2				
	50 MHz ¹	C3				
	External Input ¹	C4				
Crystal Marker	Amplitude MKR On Amplitude MKR Off	CA1 CA0				
	Intensity MKR On Intensity MKR Off	CI1 CI0				

¹ Mode disables the previous mode.

Figure 3-16. Crystal Marker Frequency (83500 series plug-ins) (2 of 2)

HP-IB ONLY FUNCTIONS

DESCRIPTION

This section describes functions which are only accessible via the HP-IB. These functions allow the HP-IB user to learn about the present instrument state, setup the instrument state, and enable some special functions to improve HP-IB operation.



FUNCTIONS

INPUT/OUTPUT LEARN STRING: A string of 90 bytes of binary data that completely describes the present instrument state (does not include the storage registers) of the 8350A and 83500 Series Plug-in. This information is packed and encoded for minimal storage requirements thereby making data analysis difficult. If data analysis is necessary, use the Output Mode String and Output Interrogated Parameter functions instead. When output from the 8350A and stored in an ASCII character data string, the Learn String can later be input to the 8350A to restore that instrument state. The length of the Learn String is fixed, independent of the functions selected and the plug-in used.

The Output Learn String function learns the present sweeper settings only. To learn the storage register settings, sequentially recall each storage register then learn the present sweeper settings. Likewise to restore the storage registers, input the learn string for the appropriate storage register then save the present sweeper settings in the proper register.

INPUT/OUTPUT MICRO LEARN STRING: A string of 8 bytes of binary data that completely describes the present CW Frequency, Vernier, Sweep Output voltage, and Power Level of the 8350A and 83500 Series Plug-in. This information is packed and encoded for minimal storage requirements thereby making data analysis difficult. When output from the 8350A and stored in an ASCII character data string, the Micro Learn String can later be input to the 8350A to restore the instrument state for rapid CW frequency programming. The length of the Micro Learn String is fixed, independent of the functions selected and the plug-in used.

In this mode the 8350A numeric displays are blanked and the Micro Learn String bytes are used to pre-load the appropriate internal DAC's. For proper operation the 8350A must be in the CW mode and the plug-in CW Filter capacitor should be off. Since the Micro Learn String overrides the present values of the 8350A when it is input, do not program any functions while in this mode. If a function is programmed one of two things may occur: 1) the 8350A may exit the Input Micro Learn String mode with the previous sweeper settings restored, or 2) the 8350A may interpret the program codes as another Micro Learn String and cause the instrument to enter a non-predicatable state. The only function that is valid for execution while the Micro Learn String is in effect is the Network Analyzer Trigger function.

To output the Micro Learn String: 1) program the desired CW frequency, 2) program the "OX" code, then 3) read the 8 byte string.

To input the Micro Learn String: program the "IX" code and the 8 byte string. When the user desires to exit the Input Micro Learn String mode and return to the normal mode of operation, the user must exit properly. When in the Input Micro Learn String mode the 8350A accepts the input program code/bytes in a special binary entry mode. The mode is exited by programming

Figure 3-17. HP-IB Only Functions (1 of 7)

the 8350A with a function code that does not start with a number (0–9) or the letters A through F since these are interpreted as possible Micro Learn String data characters. It is suggested that the user exit this mode by using the “M0” code as the mode terminator then restore the numeric displays via the “CW”, “ST”, and “PL” function codes.

OUTPUT MODE STRING: A string of 25 bytes of binary data that describes all of the presently active functions of the 8350A and 83500 Series Plug-in. This information is not packed thus allowing simple data analysis. The information passed indicates only which functions are presently active functions with no numeric values included. By determining the decimal value of each byte the user can determine which function is active. To determine the actual numeric value of some functions use the Output Interrogated Parameter function. The length of the Mode String is fixed, independent of the functions selected and the plug-in used.

OUTPUT INTERROGATED PARAMETER: The 8350A outputs the present numeric value of the instructed parameter that is to be interrogated. Any parameter that has a numeric value associated with it such as Start Frequency, Sweep Time, etc., can be interrogated. The units of the output data are Hz, dBm, dB, or sec., implied with the function selected.

OUTPUT ACTIVE PARAMETER: The 8350A outputs the numeric value of the parameter that is presently active, ie. enabled for value modification from the step keys or data entry. The units of the output data are Hz, dBm, dB, or sec., implied with the function selected.

OUTPUT STATUS: The 8350A outputs 2 sequential bytes, 8 bits wide, that indicate the present instrument status. The first status byte is equivalent to the Status Byte of the Serial Poll (the Status Byte Message), the second status byte is the Extended Status Byte which provides additional information. See the Status Byte Information table for a description of each Status Byte. Status Byte values are cleared upon execution of a Serial Poll (the Status Byte Message), Device Clear (the Clear Message), and/or Instrument Preset function command.

Status Byte Information Table

STATUS BYTE (#1)								
BIT #	7	6	5	4	3	2	1	0
DECIMAL VALUE	128	64	32	16	8	4	2	1
FUNCTION	N/A	REQUEST SERVICE (RQS)	SRQ on Syntax Error	SRQ on End of Sweep	N/A	SRQ on Change in Extended Status Byte	N/A	SRQ on Numeric Parameter Altered to Default Value

EXTENDED STATUS BYTE (#2)								
BIT #	7	6	5	4	3	2	1	0
DECIMAL VALUE	128	64	32	16	8	4	2	1
FUNCTION	Airflow Failure	*RF Unleveled	Power Failure/on	N/A	N/A	N/A	N/A	Self Test Failed

*Bit/Functions not usable with 86200 Series Plug-ins and 11869A Adapter.

Figure 3-17. HP-IB Only Functions (2 of 7)

SERVICE REQUEST MASK: This determines which bits within the 8350A Status Byte (byte #1) can cause the 8350A to send a Request Service (RQS) Message to the HP-IB controller. The Request Mask is a one 8-bit byte value where with each bit position corresponds to the same bit position as in the 8350A Status Byte. If in the Request Mask byte a bit is set (logical '1') then this condition is enabled for RQS generation. If the bit value is cleared (logical '0') then the bit is ignored. The Request Mask value ranges from decimal 0 to 255 where the decimal value can be determined by summing the decimal values of each Status Byte bit to be enabled (the user need not select the RQS bit). The default at power on is a Request Mask byte of '00000000' or decimal 0. The Request Mask is reset to the default value at power on only and is not affected by an Instrument Preset.

NETWORK ANALYZER TRIGGER (8410B): This causes an external trigger pulse to be generated for the HP 8410B Microwave Network Analyzer to re-phase lock on the present RF signal. This is used to insure proper HP-IB operation in stepped CW frequency sweeps to guarantee that the 8410B is phase-locked at the proper RF frequency after CW settling.

RESET SWEEP: This aborts the present single sweep that is in progress and resets the sweep so that it can be triggered again. This function is enabled only if the 8350A is in the Single Sweep Trigger mode and has the same effect as programming a single sweep trigger ("T4").

TAKE SWEEP: This triggers a single sweep. This function is enabled only if the 8350A is in the Single Sweep Trigger mode and has the same effect as programming a single sweep trigger ("T4").

DISPLAY UPDATE ON/OFF: This selects whether or not the 8350A updates its numeric displays upon further programming of any parameter with a numeric value. The function reduces the amount of time involved in programming the 8350A numerically related parameters (ie. CW Frequency) and aids in producing faster stepped CW frequency sweeps. The default at power on and Instrument Preset is the Display Update On state. When in the Display Update Off state, the 8350A numeric displays will be blanked.

FM SENSITIVITY (83500 Series Plug-ins Only): This selects the External FM Input sensitivity of -20 MHz per volt or -6 MHz per volt. This function is normally selected with an internal plug-in switch but can be overridden via the HP-IB. Note that the FM sensitivity is reset to the switch position after an Instrument Preset is executed. Thus the user should select the desired sensitivity after every Instrument Preset.

LIMITATIONS/CONCERNS

1. When using the Micro Learn String (both Input and Output), the 8350A must be in the CW mode and the plug-in CW Filter capacitor should be off.
2. You must exit the Input Micro Learn String mode with the "M0" code only. The numeric displays will still be blanked until the appropriate functions are re-activated.

Figure 3-17. HP-IB Only Functions (3 of 7)

3. All Learn String and Micro Learn String characters must be retained and re-input to the 8350A. If the 8350A does not receive the expected number of characters it will undergo an Instrument Preset.
4. The valid functions for the Output Interrogated Parameter are: FA, CW, CF, DF, FB, VR, SHVR, M1, M2, M3, M4, M5, SHM1, SF, SM, ST, PL, PS, SL, and SP.
5. The Request Mask byte value is reset only when another value is programmed. It is unaffected by Instrument Preset.
6. The plug-in FM Sensitivity range is reset after an Instrument Preset to the value selected by the internal switch.
7. The Output Learn String, Output Micro Learn String, Output Mode String, and Output Status functions send a Data message consisting of a string of 8-bit binary bytes terminated using the bus END command (EOI and ATN true) with the last byte. The Output Interrogated Parameter and Output Active functions send a Data message consisting of a 14 character ASCII string representing the numeric value in exponential form terminated with a Carriage Return/Line Feed (CR/LF).

Binary Syntax: [b***b] [EOI]

Numeric Syntax: [+d.dddddE+dd] [CR] [LF]

Where the character 'b' indicates an 8-bit binary byte and 'd' indicates a decimal digit (0 through 9). Note that the binary output format could have bytes that may be misinterpreted as Carriage Returns and/or Line Feeds so the user should defeat the ASCII CR/LF as valid character string terminators and rely on the byte count.

REMOTE FUNCTION PROCEDURE:

Mode	Function	Input		8350A Output Response To Input	Notes
		Prefix	Data		
Display Update On/Off	DISPLAY UPDATE ON	DUI			
	DISPLAY UPDATE OFF	DU0			
FM Sensitivity	-20 MHz/V	F1			
	-6 MHz/V	F2			

Figure 3-17. HP-IB Only Functions (4 of 7)

REMOTE FUNCTION PROCEDURE:

Mode	Function	Input		8350A Output Response To Input	Notes
		Prefix	Data		
Learn String	OUTPUT LEARN STRING	OL		90 bytes [EOI]	
	INPUT LEARN STRING	IL	90 bytes		
Micro Learn String	OUTPUT MICRO LEARN STRING	OX		8 bytes [EOI]	
	INPUT MICRO LEARN STRING	IX	8 bytes		
Mode String	OUTPUT MODE STRING	OM		25 bytes [EOI]	
Output Interrogated Parameter	OUTPUT INTERROGATE	OP	(Function Prefix)	$\pm d.dddddE\pm dd$ [CR/LF]	Valid Functions: FA, CW, CF, DF, FB, M1, M2, M3, M4, M5, VR, SHVR, SHM1, SS, ST, SM, PL, PS, SL, SP
Output Active Parameter	OUTPUT ACTIVE	OA		$\pm d.dddddE\pm dd$ [CR/LF]	
Output Status Bytes	OUTPUT STATUS	OS		2 bytes [EOI]	
Request Mask	REQUEST MASK	RM	1 byte		
Reset Sweep	RESET SWEEP	RS			
Take Sweep	TAKE SWEEP	TS			

Figure 3-17. HP-IB Only Functions (5 of 7)

MODE STRING (1 of 2)			
Byte #	Bit Usage 76543210	Example	Description
1	00000000 00000001 00000010	0 1 2	SWEEP MODE: Start/Stop CW CF/ Δ F
2	00000000 00000001 00000010 00000011	0 1 2 3	SWEEP TRIGGER: Int Line Ext Single
3	00000000 00000001 00000010	0 1 2	SWEEP SOURCE: Time Man Ext
4	0000----1 0000--1- 0000-1-- 00001---	On On On On	MODULATION/BLANKING: Amplitude Mkr On/Off (On=1, Off=0) Display Blanking On/Off RF Blanking On/Off Sq. Wave Modulation On/Off
5	00000000 00000001 00000010 00000011 00000100	0 1 2 3 4	ACTIVE MARKER #: M1 M2 M3 M4 M5
6	00000000 00000001 00000010 00000011 00000100	0 1 2 3 4	REFERENCE MAKRER #: M1 M2 M3 M4 M5
7	000----1 000--1- 000-1-- 000-1--- 0001----	On On On On On	MARKERS ON/OFF: M1 (On=1, Off=0) M2 M3 M4 M5
8	00000000 00000001 00000010	0 1 2	COUNTER TRIGGER PARAMETER: Start Freq. Stop Freq. Marker Freq.
9	-----1 -----1- -----1-- -----1--- ----1---- ---1----- --1----- -1----- 1-----	On On Yes Yes On On On On On	SPECIAL CONDITIONS: Non-Swept CW On/Off (On=1, Off=0) Default Step Size On/Off Vernier Negative Yes/No (Yes=1, No=0) Offset Negative Yes/No Mkr Δ Mode On/Off Mkr Sweep Mode On/Off Counter Trigger On/Off Alt. Sweep On/Off
10	00000000 00000001 00000010 00000011 00000100 00000101 00000110	0 1 2 3 4 5 6	KEYBOARD ASSIGNMENT: Start Stop CW/CF Δ F Vernier Offset Markers

Figure 3-17. HP-IB Only Functions (6 of 7)

MODE STRING (2 of 2)			
Byte #	Bit Usage 76543210	Example	Description
10 (Cont'd)	00000111	7	Step Size
	00001000	8	Sweep Time
	00001001	9	Manual Sweep
	00001010	10	Save/Recall/Alt
	00001011	11	Hex Entry Address
	00001100	12	Hex Entry Data
	00001101	13	Key Test
	00001110	14	HP-IB Address
	01111111	127	None
	01000000	128	Power Level
01000001	129	Power Sweep	
01000010	130	Slope	
11	00000000	0	ALTERNATE REGISTER #: 0
	00000001	1	1
	00000010	2	2
	00000011	3	3
	00000100	4	4
	00000101	5	5
	00000110	6	6
	00000111	7	7
	00001000	8	8
00001001	9	9	
12	00000000	0	NOT DEFINED
13	00000000	0	ALC Mode: Int
	00000001	1	Ext
	00000010	2	Mtr
14	000000-1	On	POWER CONTROL: CW Filter On/Off (On=1, Off=0)
	0000001-	On	Power Sweep On/Off
15	000000-1	On	POWER FUNCTIONS: Slope On/Off (On=1, Off=0)
	0000001-	On	Power Sweep On/Off
16	000000-1	On	CRYSTAL MARKER MODES: Amplitude Mkr On/Off (On=1, Off=0)
	0000001-	On	Intensity Mkr On/Off
17	00000000	0	CRYSTAL MARKER FREQUENCY: 1 MHz
	00000001	1	10 MHz
	00000010	2	50 MHz
	00000011	3	Ext Freq
18	00000000	0	FM INPUT SENSITIVITY: -20 MHz/V
	00000001	1	-6 MHz/V
19	00000000	0	NOT DEFINED
20	00000000	0	
21	00000000	0	
22	00000000	0	
23	00000000	0	
24	00000000	0	
25	00000000	0	
END OF MODE STRING			

Figure 3-17. HP-IB Only Functions (7 of 7)

LOCAL OPERATION

8350A SWEEP OSCILLATOR

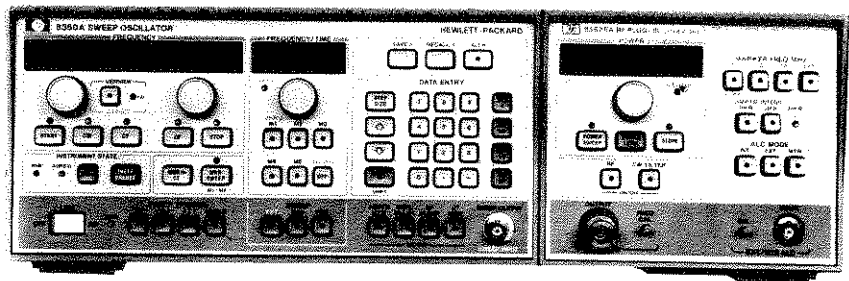

 **HEWLETT
PACKARD**

8350A SWEEP OSCILLATOR

© Copyright HEWLETT-PACKARD COMPANY 1980
1400 FOUNTAIN GROVE PARKWAY, SANTA ROSA, CALIFORNIA 95404

MANUAL PART NO. 08350-90001
Microfiche Part No. 08350-90002

Printed: AUGUST 1980



**HEWLETT
PACKARD**

LOCAL OPERATION

INTRODUCTION

This Local Operation handbook provides information on the local use (non HP-IB) of the 8350A Sweep Oscillator with 83500 series Plug-ins. Throughout this handbook are blocks of example procedures on implementing some of the information. The front panel controls are divided into function groups. These groups and other information topics are arranged in the following sequence:

- GETTING STARTED – Brief example of control usage.
- INSTRUMENT PRESET – Error codes and preset conditions.
- DATA ENTRY – Numeric, step, units, and shift keys.
- FREQUENCY – Mode selection, vernier and offset.
- FREQUENCY/TIME – Markers and sweep control.
- SAVEn/RECALLn/ALTn – Storage Registers, Step Up Advance.
- DISPLAY FUNCTIONS – Blanking, Modulation, and Sweep Out/In.
- 83500 SERIES PLUG-INS – Power, signal, and crystal markers.
- USE WITH SPECIFIC MEASUREMENT EQUIPMENT:
 - HP 8755S Frequency Response Test Set
 - HP 8410B Network Analyzer
 - HP 7010B and other X-Y Recorders
 - HP 5343A Frequency Counter
- APPENDIX 1 – Rear panel connector information.
- APPENDIX 2 – Use of 86200 series Plug-Ins with 11869A Adapter.
- APPENDIX 3 – Summary of Sweep Oscillator front panel controls with fold-out front panel drawing.

GETTING STARTED

NOTE

If a 86200 series RF Plug-in and 11869A Adapter are used, the plug-in coding on the adapter must be set properly to get the correct frequency display.

When the 8350A is turned on or when the INSTR PRESET key is pressed the front panel of the 8350A is set to the following pre-determined state: The RF output is swept over the full frequency range of the plug-in at the maximum specified leveled output power, minimum sweep time for the RF Plug-in installed, and the internal square wave amplitude modulation is off.

Example:

8350A with 83525A 0.01-8.4 GHz Plug-in

To change from the INSTR PRESET state to 4.2 to 6.2 GHz sweep (in START/STOP mode), 0.20 second sweep time, +4.5 dBm output power, 27.8 KHz square wave modulation on RF output:

1. Press the **START** key and then rotate the START control clockwise to increase the start frequency until the display above the START key reads 4.200 GHz
2. Rotate the STOP control counterclockwise to decrease the STOP frequency to 6.500 GHz.
3. Press the **TIME** key, then turn the FREQUENCY/TIME control clockwise to increase the sweep time to 0.2 second (displayed on the FREQUENCY/TIME display).
4. Press **MOD** key to activate the internal 27.8 KHz square wave modulation. The lamp in the center of the key will be on.
5. Press the **POWER LEVEL** key, then turn the plug-in POWER control until the display reads +4.5 dBm.

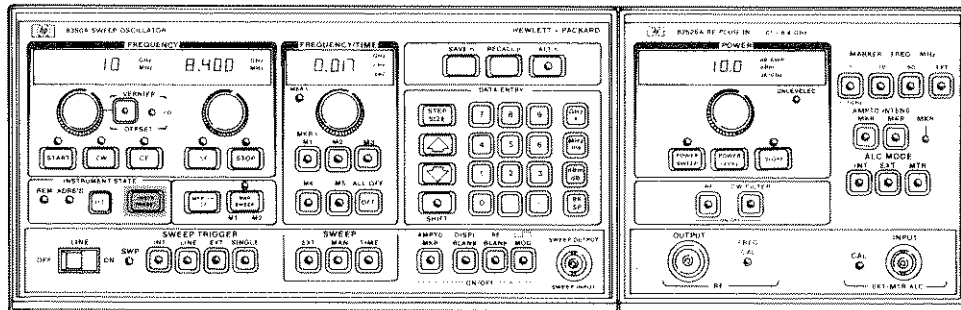
**INSTRUMENT PRESET**

This condition occurs when the power is turned on or when the INSTR PRESET key is pressed.

INSTR PRESET causes an internal self test to occur after which the instrument will be set to the preset condition. If certain internal errors or failures are detected during the self test or during normal operation of the 8350A they are indicated via error codes in the form "Ennn" (where $n = 0, \dots, 9$) read from the left FREQUENCY display. For a complete description of the error code listing see the Operating and Service Manual Section 8. The error codes are:

- E001 Plug-in interface failure. Check plug-in.
- E002 Sweep voltage DAC/Marker voltage DAC failure
- E003 Tuning voltage DAC/Marker voltage DAC failure

Figure 1. Instrument Preset Key (1 of 2)

- E004 Power supply failure
- E005 Instrument interface bus failure
- E006 Front panel bus failure
- E007 ROM failure
- E008
- E009
- E010
- E011 RAM failure
- E012
- E013
- E014
- E015 Microprocessor failure
- E016 Insufficient cooling. Check fan.

If the self test completes without errors the instrument presets to:

SWEEP MODE: START/STOP, over full frequency range of plug-in

SWEEP TIME: fastest allowable for plug-in

MARKERS: off

MODULATION: off

SWEEP TRIGGER/SWEEP: INT, TIME

VERNIER/OFFSET: 0 MHz

DISPLAY BLANKING: on

SAVE/RECALL: Initial power on sets all memory locations to INSTR PRESET state, if using 8350A Option 001 (Non-Volatile Memory) or if instrument is already on, the memory values remain unchanged when INSTR PRESET is pressed.

ALL OTHER FUNCTIONS: off

When using 83500 series Plug-ins:

POWER LEVEL: maximum specified leveled value

RF and CW FILTER: on

ALC MODE: INT

CRYSTAL MARKERS: off (83522A, 83525A only)

ALL OTHER FUNCTIONS: off

Figure 1. Instrument Preset Key (2 of 2)

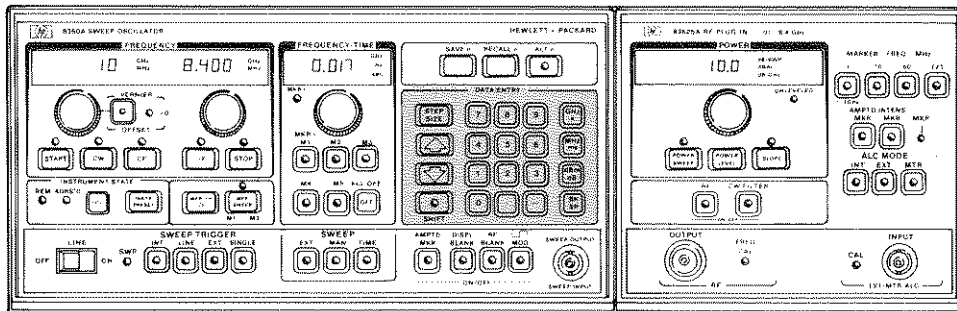

DATA ENTRY

This section contains the numeric keyboard, terminators (i.e., GHz, seconds, dBm), step size/up/down, backspace and shift keys. In addition to using the appropriate control, a function value can be set to an exact value or incremented by a specific amount via the keyboard.

Number/unit keys

These keys are used to enter values of frequency, time or power. Holding a number key down causes it to repeat.

Example:

To enter a START frequency of 1.870 GHz:

Press **START** **1** **.** **8** **7** **GHz/sec**

or

START **1** **8** **7** **0** **MHz/ms**

to enter the equivalent frequency in MHz.

Backspace Key BK SP. Prior to pressing a units key the value entered from the keyboard may be changed via the BKSP key without effecting the current instrument state. The backspace key allows the user to alter digits already entered.

Step UP and Step DOWN keys

These keys increment or decrement the active parameter (including memory registers) by the STEP SIZE or preset amount. By holding either key down the 8350A will continue to step

Figure 2. Data Entry (1 of 2)

therefore eliminating the need for the user to repeatedly press the step keys. The STEP UP function may be engaged via the remote STEP UP ADVANCE on the rear panel Programming Connector. The STEP UP ADVANCE is incremented by supplying contact closure to ground or logical 0 to pin 22.

STEP SIZE

This key is used to enter a frequency or power increment to be used with the UP or DOWN key. The STEP SIZE key is pressed before the quantity is entered. A frequency step that is entered is common for START, STOP, CF, CW, ΔF , VERNIER, OFFSET, MARKER and MANUAL SWEEP parameters. A power step is used for varying POWER LEVEL, POWER SWEEP and SLOPE. Default values are assigned at power on and instrument preset for step sizes until new values are entered. Note that a step size cannot be set for sweep time. The keyboard and step keys affect the last active function. The entered Step Size is not displayed.

Example:

To set a 250 MHz step size:

Press **STEP SIZE** **2** **5** **0** **MHz/ms**

After this, each time the UP or DN key is pressed the active frequency parameter will change by 250 MHz.

SHIFT key (BLUE)

This key is used to activate the functions coded in blue and some special functions. The lamp in the center of this key is on when the key is active.

Example:

Press **M1** **M2** **M3** **M4** **M5**

(MARKERS) ALL OFF. Pressing SHIFT, OFF turns off all markers.

The SHIFT key is also used to set the HP-IB address. Press **SHIFT** **LCL**; the FREQUENCY/TIME display will indicate the present HP-IB address number. The address may be changed to any value between 0 and 30 by using the keyboard to enter a number and the GHz, MHz or dBm key as a terminator. The 8350A is factory preset for an HP-IB address of 19.

NOTE

Address number 21 is normally reserved for calculator addressing and HP-IB interface functions and should not be used.

Figure 2. Data Entry (2 of 2)

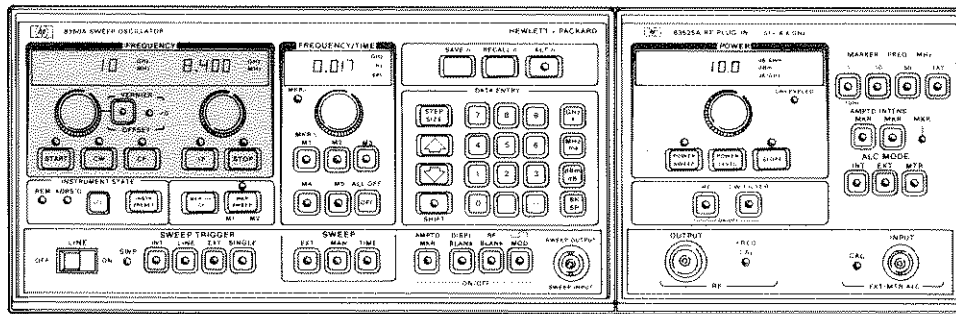

FREQUENCY

This section controls the sweep mode and frequency limits.

START/STOP

When either the **START** or **STOP** key is pressed the sweep oscillator is put in **START/STOP** mode. Swept RF output begins at **START** frequency and ends at **STOP** frequency. The **START** frequency must be less than or equal to the **STOP** frequency. The vernier and offset can be used to change the effective center frequency of the sweep. Left **FREQUENCY** display is start frequency of sweep; right **FREQUENCY** display is stop frequency. Frequencies may be changed in three ways.

- Frequency controls – Provides continuous adjustment. Clockwise rotation increases frequency.
- Data entry – Can enter specific frequency values from the number/units keyboard.
- Step up/down – enter step size (in GHz or MHz) using **DATA ENTRY** keyboard section. By first pressing the appropriate key (**START** or **STOP**) and then the **UP** or **DOWN** key can now increment or decrement the appropriate frequency sweep limit. If a step size has not been entered the function will change by the default value when **UP** or **DOWN** is pressed.

CF (CF/ΔF)

Puts display in mode where swept output is read as a center frequency and frequency sweep width. Output is swept from $CF - \Delta F/2$ (start frequency) to $CF + \Delta F/2$ (stop frequency). When changing between **CF/ΔF** and **START/STOP** modes only the method of display changes, the swept RF output remains the same.

When either **CF** or **ΔF** is activated the left display is center frequency (**CF**), the right display is delta frequency (**ΔF**). Both the **CF** and **ΔF** can be changed via the appropriate control, number/units keyboard and step size keys.

CW

When activated causes the 8350A to output a constant frequency. The value of the **CW** frequency is displayed on left **FREQUENCY** display. The **CW** frequency is the same as the center frequency (**CF**) of the previous swept range. The **CW** frequency value can be changed using the

Figure 3. Frequency Controls (1 of 2)

control, data entry keyboard or step keys. In CW mode, the SWEEP OUT voltage is equal to percent of full band. Pressing SHIFT, CW enters a "swept" CW mode with the SWEEP OUT being a 0 to 10 volt ramp that results in the display trace being a flat horizontal line. This is often useful when reading values (e.g., dB of attenuation) from a CRT screen when at a CW frequency.

FREQUENCY VERNIER

The effective center frequency of any mode (CW or swept) may be adjusted with high resolution up to $\pm 0.05\%$ of the frequency band being used with the vernier. Pressing the VERNIER key activates the function and sets the left FREQUENCY display to read the vernier value in MHz.

1. " $\neq 0$ " light is on whenever a frequency vernier or frequency offset is present in any mode. After setting vernier, to return to the previous mode, press the appropriate key (e.g., START, CF, etc.) and the display will return to reading the appropriate frequencies and the " $\neq 0$ " lamp will be lit.
2. Frequency vernier can be set by the control, data entry keyboard or step keys.
3. The displayed vernier adjustment can be up to $\pm 0.05\%$ of the frequency band being swept. When in a sub-band of a multiband plug-in (for example, the 0.01-2 GHz band of the 83525A .01-8.4 GHz plug-in) the adjustment range will be $\pm 0.05\%$ of the sub-band. This feature allows for better frequency resolution than would otherwise be possible with the vernier when using a multiband plug-in.
4. The vernier adds its value to the appropriate frequency parameter and then resets to zero when the adjustment exceeds $\pm 0.05\%$ for continuous adjustment.
5. ZEROING VERNIER. To set the vernier to zero, press VERNIER 0 MHz/ms and the " $\neq 0$ " lamp will turn off.

FREQUENCY OFFSET

The frequency offset feature allows the CW frequency and/or the effective center frequency of the swept range to be shifted by any amount up to the full range of the plug-in.

1. To enter an offset press SHIFT VERNIER and enter the offset by either the left FREQUENCY control or data entry keyboard. The amount of offset (in GHz or MHz) will be shown in the left FREQUENCY display and the " $\neq 0$ " lamp will be lit.
2. To exit the displayed offset mode press the appropriate mode key (i.e., START, CW, etc.). The sweep limits displayed will appear to be unchanged, however the " $\neq 0$ " lamp will be on indicating the offset is present and the actual RF output frequency will be shifted.
3. To return display or adjustment the frequency offset press SHIFT VERNIER. To zero the offset press SHIFT VERNIER 0 MHz.

OVERRANGE

The 8350A will permit frequency sweeps beyond the specified range of the plug-in by $\pm 2.0\%$ of the plug-in bandwidth. However, plug-in performance in the overrange condition is unspecified.

As a warning of the frequency overrange condition the GHz or MHz annunciator will flicker in the appropriate function display.

Figure 3. Frequency Controls (2 of 2)

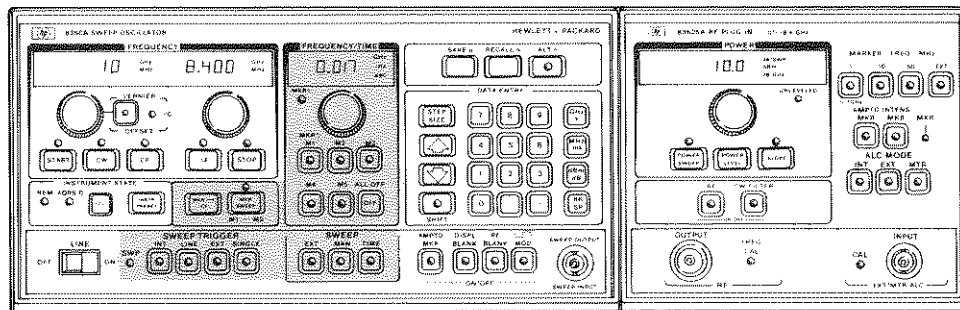

FREQUENCY/TIME

This display will read either GHz, MHz or sec depending upon the presently active function and range. This section controls five mainframe markers, manual sweep, and the sweep time. The five independent frequency markers can be displayed simultaneously as intensified dots on a CRT using the Z-axis or amplitude dips on the RF output.

SWEEP

Controls the rate at which the RF output is swept.

TIME. When the TIME key is pressed the output is swept at the user-specified or default rate. If time key is lit but display reads GHz/MHz or is blank, press TIME key again and display will read seconds. The mainframe can allow sweep times from 100 seconds to 0.01 second although the minimum sweep time is dependent on the plug-in being used and bandwidth being swept.

When display reads seconds, sweep time can be adjusted with the control knob or data entry keyboard. The step keys can be used to adjust the sweep time in a 1-2-5 sequency.

MANUAL SWEEP(MAN). FREQUENCY/TIME display will read GHz/MHz. By using the FREQUENCY/TIME control, step keys or data entry keyboard, it is possible to manually sweep the frequency range with the display indicating the present output frequency.

EXTERNAL SWEEP(EXT). The 8350A can be swept via an external voltage. Apply 0 to 10 volts into sweep output/input (can use BNC connector on front or rear panel) with 0V input corresponding to the lower frequency limit of the sweep range and 10V corresponding to the upper limit. DC sweep input voltages will cause CW frequency outputs. Markers and blanking outputs are disabled when in external sweep mode.

SWEEP TRIGGER

Controls when the sweep will begin in the timed sweep mode. The sweep light, SWP, is lit when the sweep is occurring.

INT. Sweep triggered internally, free running.

LINE. Sweep triggered by power line frequency.

Figure 4. Frequency/Time Controls (1 of 3)

EXT. The sweep can be triggered externally by applying a positive going signal from 0 to 2 volts minimum, +20 volts maximum to Programming Connector pin 9. The trigger signal must be wider than 0.5 microsecond at less than a 1 MHz repetition rate.

SINGLE. This key selects single sweep mode and aborts present sweep when first pressed. Subsequent keying will trigger or abort single sweeps at current sweep time.

MARKERS

Any or all of the five markers (M1 through M5) may be enabled by pressing the marker key corresponding to the marker desired. When a marker is activated it is set to its last active frequency unless INSTRUMENT PRESET has been activated in which case the marker will be set to the center of the fullband sweep. A marker can be in one of three states:

- ACTIVE – Lamp in center of key flashing.
- ON – Lamp on.
- OFF – Lamp off.

Only one marker at a time (the “active” marker) can have its value altered. The five mainframe markers are normally supplied through the positive Z-axis blanking pulses connector on the rear panel. By pressing the AMPTD MKR key the markers may be displayed as amplitude dips on the RF output.

- When a marker is active the keyboard, FREQUENCY/TIME control and step keys can be used to modify its value. The value of the active marker in GHz/MHz is displayed.
- By pressing OFF, the active marker only will be turned off. If multiple markers are on, the remaining lamps will remain lit although the display will go blank.
- A marker may be initially activated or returned to active state by pressing the corresponding marker key.
- All markers may be turned off simultaneously by pressing SHIFT, OFF.

Example:

Press **M3** (Note M3 lamp flashing other lamps off.)

Press **M5** (Note M5 lamp flashing, M3 lamp on and other lamps off.)

MKR (Marker) SWEEP. In this mode the RF output is swept between markers M1 and M2. The lamp over the key will be on. Marker 1 must be less than or equal to Marker 2 in frequency (if M1 is greater than M2 the values of M1 and M2 are permanently interchanged). By varying the active marker (1 or 2) or by turning the START/STOP controls the sweep limits can be altered. When both M1 and M2 are not on, the sweep occurs between the most recent values of M1 and M2. To exit this mode press MKR SWEEP and the lamp over the key will go out. Pressing SHIFT, MKR SWEEP causes the values of M1 and M2 to become the START/STOP frequency values permanently.

Figure 4. Frequency/Time Controls (2 of 3)

MARKER-TO-CENTER FREQUENCY (MKR→CF). When this key is pressed the frequency of the active marker becomes the center frequency of the swept output. The frequency span remains unchanged if within the frequency limits of the plug-in. If original frequency span exceeds plug-in limits, the frequency span will be reduced to retain symmetry.

MKR Δ. This function allows the frequency difference between any two markers to be displayed and the trace between them intensified (if intensity markers are selected).

1. Press **SHIFT M1** the display shows the frequency difference between the currently active marker and the one that was previously active.
2. The **FREQUENCY/TIME** control, keyboard and step keys can change the active marker value.
3. To exit **MKR Δ** mode press **OFF**.

Example:

1. Press **M4** and set frequency via **DATA ENTRY** keyboard or Control to 2 GHz.
2. Press **M2** and set frequency via **DATA ENTRY** keyboard or Control to 2.4 GHz.
3. Press **SHIFT MKR Δ** (Note Frequency/Time display reads difference between Marker 4 and Marker 2, 400 MHz).

Figure 4. Frequency/Time Controls (3 of 3)

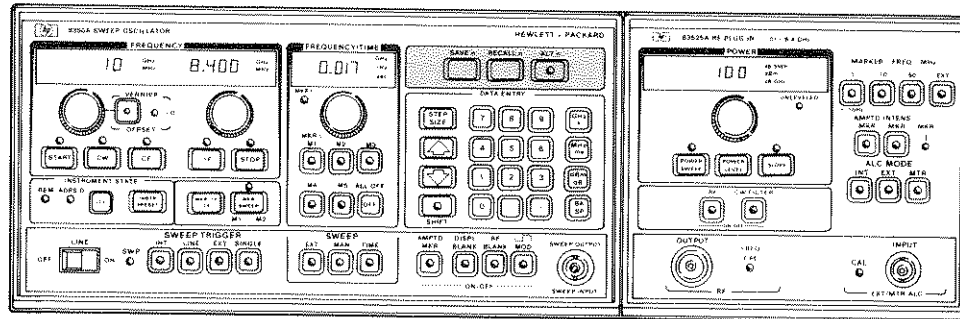

SAVE_n/RECALL_n/ALT_n

SAVE_n/RECALL_n

The 8350A is equipped with memory registers which allow up to nine complete front panel settings (frequency range, markers, power level, etc.) to be stored and later recalled. Instrument settings are stored in memory locations 1 through 9 by pressing SAVE_n and 1, . . . , or 9. To recall a stored instrument setting press RECALL_n and 1, . . . , or 9. The STEP keys may be used to step through the stored registers. The instrument settings stored in memory may be recalled remotely in sequence by using the Step Up Advance on pin 22 of the Programming Connector on the rear panel of the 8350A. A contact closure to ground or logic 0 is used to implement this function.

ALT_n

ALT_n causes the 8350A to alternate between the current instrument state and the setting stored in memory location *n* (where *n*=1, . . . , 9) on successive sweeps. When the 8350A is in this mode the lamp will be on and the SAVE_n and RECALL_n keys disabled. To exit from the ALT_n mode press the key again, the lamp will turn off and the SAVE_n/RECALL_n keys will become operational. When using the 8350A with an HP 8755C Swept Amplitude Analyzer, channel 1 displays the current instrument state and channel 2 displays the stored setting (provided the 8350A/8755C ALT SWP INTERFACE cable is connected).

Figure 5. Save *n*, Recall *n*, and ALT *n* Keys

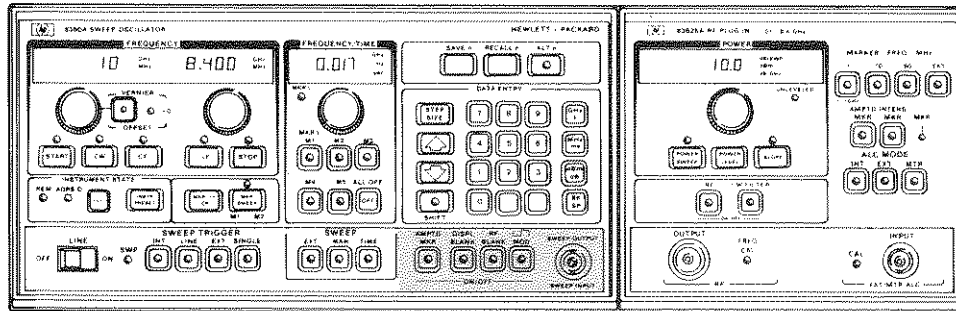

DISPLAY FUNCTIONS

AMPTD MKR, DISPL BLANK, RF BLANK. (Function in effect when lamp in center of key is lit)

DISPL BLANK ON/OFF. Blanks the display during the retrace via the POS Z BLANK or NEG Z BLANK outputs.

RF BLANK ON/OFF. Blanks (turns off) the RF power during the retrace.

AMMOD ON/OFF. Activates the internal 27.8 KHz square wave amplitude modulation of the RF output. This feature makes the 8350A directly compatible with the HP 8755 Frequency Response Test Set. The 8350A may be modified via an internal jumper to provide 1000 Hz square wave amplitude modulation for instruments like the HP 415E SWR Meter (refer to the Operating and Service Manual, Section 5). 5-21

SWP (Sweep) OUTPUT/SWP (Sweep) INPUT (BNC connection).

SWP (Sweep) OUTPUT. Supplies a 0 to 10 Volt signal when 8350A is in MAN or TIME sweep mode. 0V output is at the start frequency of sweep, 10V output is at the stop frequency of sweep. In CW mode the output is a dc voltage proportional to the percent of full band. Can be used to drive the X-axis on a CRT or X-Y recorder.

SWP (Sweep) INPUT. Used when in EXT SWEEP mode. Supplying a dc voltage will tune RF where 0 volts tunes to the lower frequency of the set sweep and 10 volts tunes to the upper frequency. The input can be a ramp for a swept output or DC for a CW frequency. The display and RF blanking must be off when externally sweeping.

Figure 6. Display Function Keys

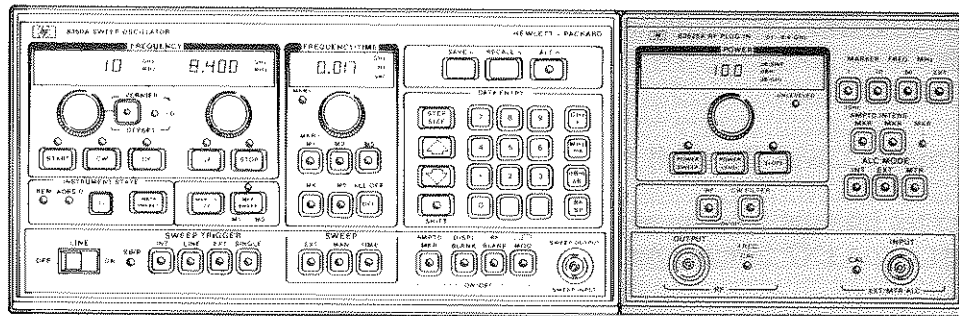

83500 SERIES PLUG-IN

Power Control

POWER LEVEL. When pressed, the plug-in display indicates the RF output power. The output power may be varied using the **POWER** control, keyboard or step size keys. Note that the internal leveling must be on and the unlevel light out for calibrated output power. The power is typically calibrated over a 15 dB range (80 dB with plug-in Option 002, Step Attenuator).

SLOPE. Compensates for high frequency power losses in external RF cables by increasing the power at higher frequencies. This compensation provides a flat RF signal output at the end of a cable or test set. Press **SLOPE** and the display will indicate the dB per GHz of the present sweep of compensation desired. Use the **POWER** control, keyboard or step keys to enter the amount of slope. Press **SLOPE** again to remove all compensation.

POWER SWEEP. This function enables the output power to be swept up. The maximum calibrated power sweep range is typically 10 dB. Note that when using plug-ins with Option 002 Step Attenuator, the power cannot be swept across the internal attenuator switch points. The procedure for performing a power sweep is:

1. After selecting the output frequency (sweep range or "swept" CW mode) use the power level to set the starting value for the power sweep.
2. Press the **POWER SWEEP** key, the display will now read the dB/SWP. By using the **POWER** control, data entry keyboard or step keys set the desired sweep range. Press the **POWER SWEEP** key again to turn the power sweep off.

Figure 7. Plug-in Controls (1 of 2)

Signal Control

RF ON/OFF. Turns the RF power on and off.

CW FILTER ON/OFF. When on, this filters the internal oscillator's tuning voltage to provide a more stable CW or MANUAL SWEEP frequency output. During swept operation this filter is always disabled.

ALC (Automatic Level Control) Mode: INT, EXT, MTR

INT. Provides internal leveling of output power at the output connector. The 83500 series Plug-in must be on INT leveling for calibrated output power.

EXT. This setting is used when leveling with an external crystal/diode detector. The front panel EXT ALC input accepts negative voltages in the -25 to -250 millivolt range (typically).

MTR. Used when leveling output power with an HP 432A/B/C Power Meter.

CAL. Adjusts the ALC gain so the display can be calibrated by an external power meter or detector.

CRYSTAL MARKERS (83522A, 83525A Plug-ins only)

50, 10, and 1 MHz crystal frequency marker combs are available. The 50 and 10 MHz are available at frequencies less than 2 GHz while the 1 MHz markers are available under 1 GHz.

AMPTD/INTENS. The markers can be set to be amplitude dips (on the RF output) and/or intensified spots (on the Z-axis of the CRT) or both. They are independent of the mainframe markers.

EXT (External Marker). An external frequency marker can be input through the rear panel of the plug-in. The marker appears when the RF output frequency equals the marker frequency. The external marker input power should be between -10 dBm and $+10$ dBm.

MKR Lamp. When the 8350A is in CW or manual/external sweep mode the MKR Lamp will light when the CW frequency is at a marker frequency. Useful when an accurate CW frequency reference is desired and to calibrate plug-ins.

RF OUTPUT CONNECTOR

Type N female. The 83570A 18 to 26.5 GHz Plug-in is equipped with a WR-42 waveguide output connector.

Figure 7. Plug-in Controls (2 of 2)

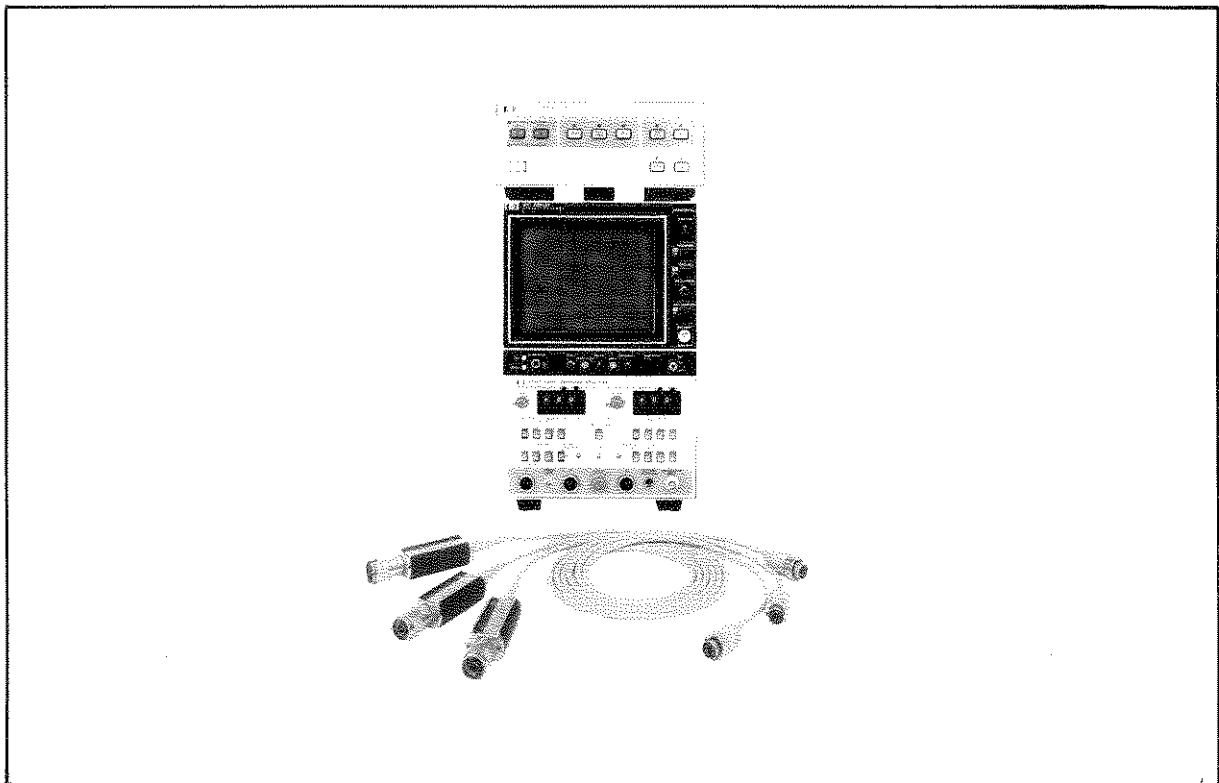

Figure 8. Frequency Response Test Set

INTERFACING THE 8350A WITH SPECIFIC MEASUREMENT EQUIPMENT

8755S FREQUENCY RESPONSE TEST SET

The 8755S consist of:

- 8755C Swept Amplitude Analyzer
- 182T Oscilloscope
- 11664A Detectors (3 each)
- 8750A Storage-Normalizer

The 8755S is used for scalar transmission and reflection measurements requiring up to 60 dB of dynamic range and for absolute power measurement from -50 dBm to $+10$ dBm.

The 8350A has the following features designed specifically for use with the 8755S Frequency Response Test Set:

RF Square-wave Modulation. By engaging the \square MOD key an internally generated squarewave modulation of the RF output is available thus eliminating the need for external modulating equipment. A jumper internal to the 8350A enables the square wave modulation frequency to be changed to 1 KHz (see section 5 of the Operating and Service manual for details).

Alternate Sweep Function. The ALTn function of the 8350A allows two different frequency and power settings to be swept on successive sweeps. The front panel setting and the setting stored in a memory register location n ($n=1, \dots, 9$) can be selected for alternate sweeps. The Alternate Sweep Function will not work properly with the 8755A or 8755B. See Figure 9 for a sweep display of the ALTn function when used to view a bandpass response at different resolutions and offsets.

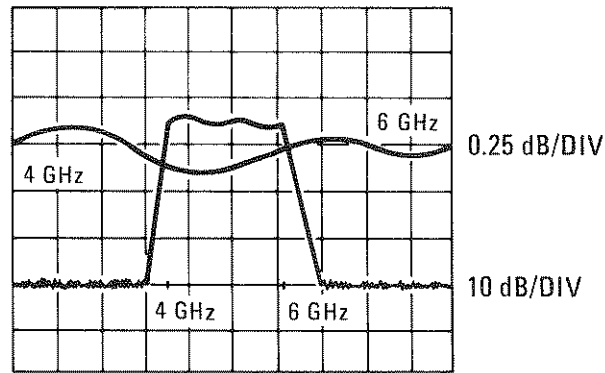

Figure 9. Alternate Sweep Function Display

Some other features enhancing the convenience and versatility of the 8755S are:

Marker Δ . The MKR Δ function is useful when using alternate sweep in overlapping different sweep widths. The overlapping portion of one of the sweeps can have an increased intensity. The 8750A Storage-Normalizer will need to be in BYPASS mode to view Z-axis modulation on the oscilloscope.

Power Sweep. The RF output power may be ramped up when the sweeper is in the swept or "swept" CW mode by using the POWER SWEEP function. See Figure 10 for a gain compression display using power sweep.

Save and Recall. This function allows the storage and recall of nine complete instrument settings.

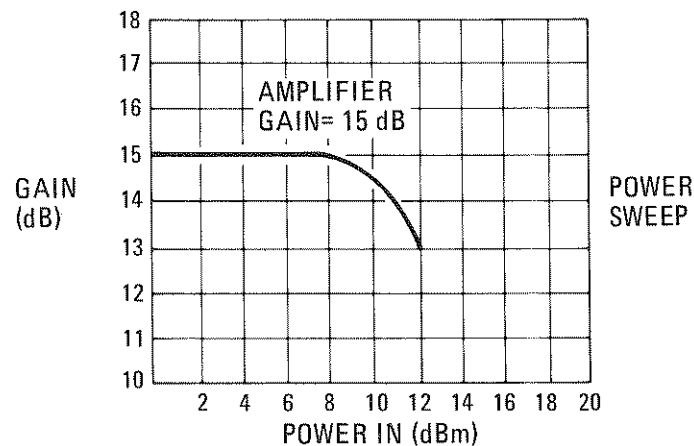

Figure 10. Gain Compression Display

Figure 11 outlines the general procedure used in making a scalar transmission and reflection measurement. The 11692D Dual-Directional Coupler is used in the example but if a 11666A Reflectometer Bridge is available it may be used instead of the Coupler and two detectors (8755S Option 002).

To keep the following procedure brief the 8750A will not be used (switched to BYPASS) in the procedure. The following anomalies exist when using the 8750A with the 8350A Sweep Oscillator:

- The 8350A DISPL BLANK must be engaged to ensure triggering 8750A updating.
- Intensity markers are changed to amplitude markers. In MKR Δ mode they appear as a level shift over the MKR Δ range.
- If an 8755 channel is switched off the trace goes to the reference line (bottom of CRT).

Example:

1. Connect the equipment as shown in Figure 11. Initially, the 8350A should be set by pressing **INSTR PRESET** and **LMOD** (Set to 27.8 KHz) which will set the front panel instrument state and activate the internal square wave modulation.

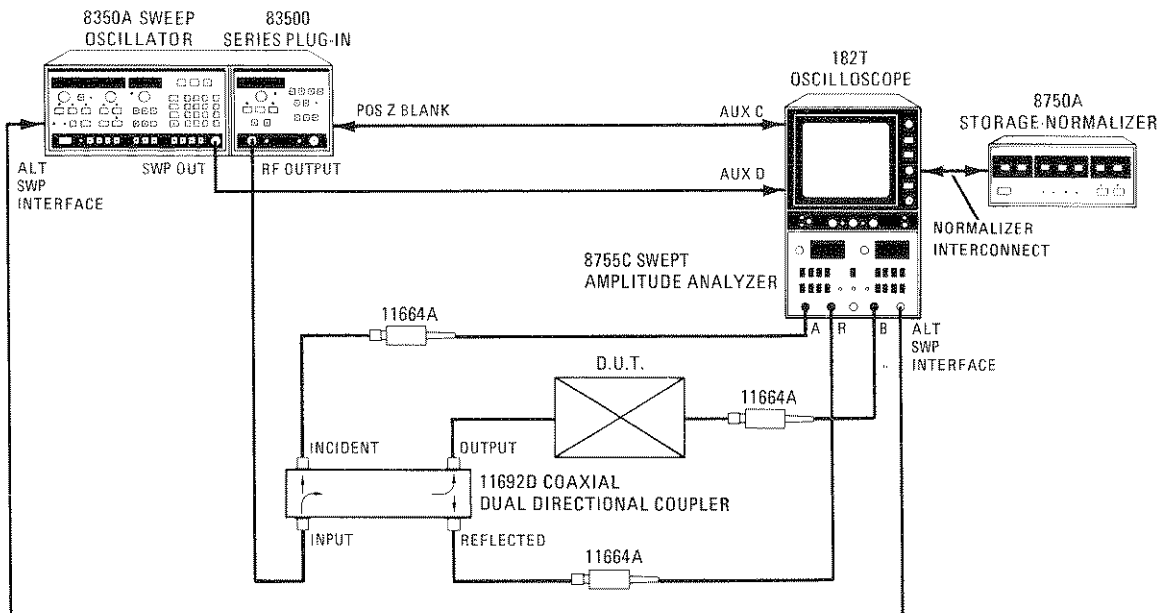

Notes on connections:

- Either the front or rear panel SWEEP OUT/IN may be used.
 - When in ALTn mode both channels 1 and 2 (on 8755) must be on and receiving inputs.
2. Turn off channel 1 on the 8755C by releasing the display pushbutton. Set the 8350A controls as desired. On channel 2 set the function, dB/DIV and Offset desired for viewing the current sweep setting.
 3. Set the 8350A controls as desired then store the current 8350A sweep setting in any available memory location. Then turn off channel 2 by releasing its display pushbuttons.
 4. Turn on Channel 1 of the 8755C and set the function, dB/DIV and Offset as desired. Set 8350A controls as desired.
 5. Turn on channel 2. Press **ALTn**, n and the 8350A will alternate between the two settings on successive sweeps.

Channel 1 now displays the response due to the current front panel setting while channel 2 displays the response to the setting stored in memory location n. The front panel controls of the 8350A are enabled and the current sweep setting may be altered if necessary.

Figure 11. Typical Test Setup Using 8755S

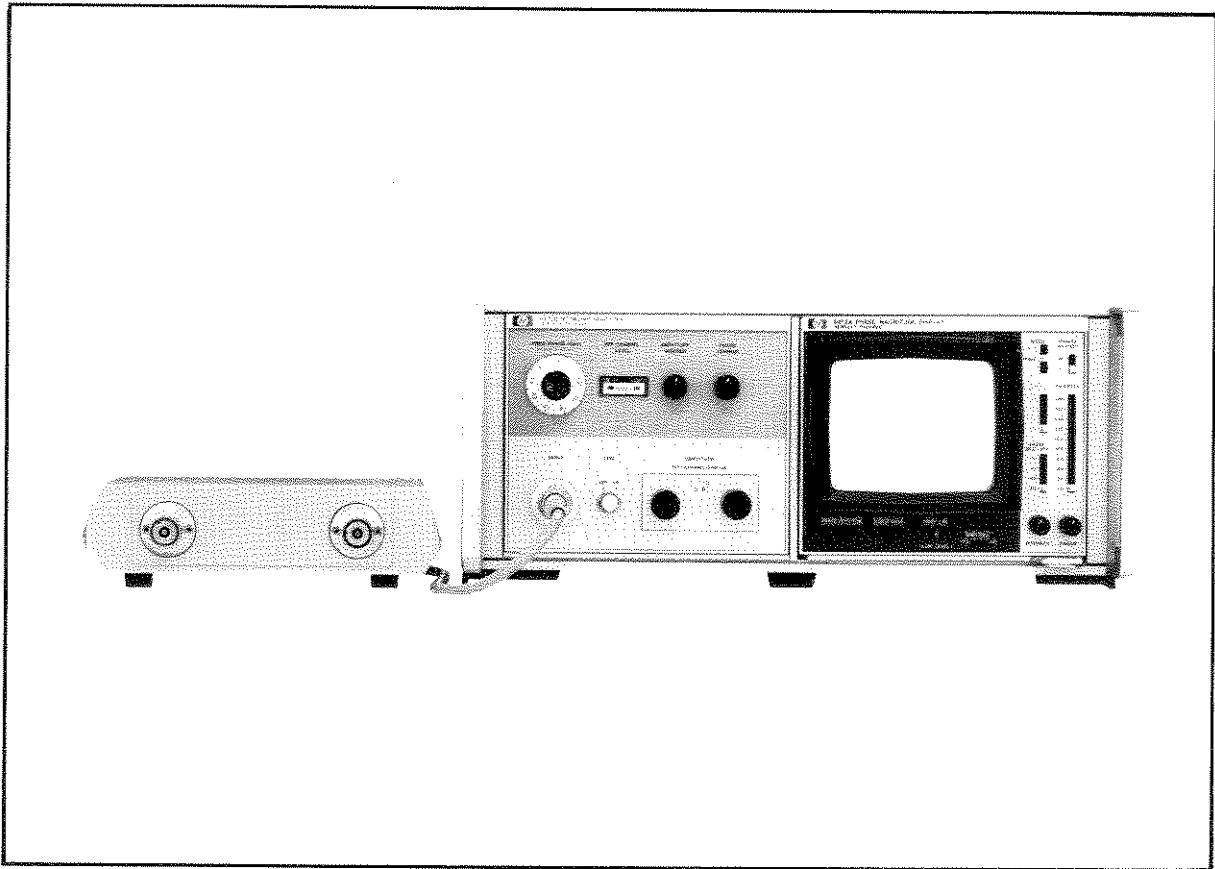

Figure 12. 8410B Network Analyzer

8410B NETWORK ANALYZER

The 8350A is compatible with the 8410B Network Analyzer systems and accessories. The Source Control Cable (HP P/N 08410-60146) synchronizes the two instruments to provide continuous multi-octave coaxial magnitude and phase measurement capability from 110 MHz to 18 GHz with 65 dB dynamic range. The frequency markers can be displayed in polar format as intensity dots (Z-axis). Frequency markers derived from crystal oscillators allow frequency measurements to be made with an accuracy of five parts per million.

Waveguide measurements between 18 and 26.5 GHz can be made with the K8747A Reflection/Transmission Test Unit which is designed for use with the 8410B. This test system utilizes two 8350A Sweep Oscillators and 83570A 18 to 26.5 GHz RF Plug-ins. One sweeper is used as a local oscillator while the second is used to sweep the desired frequency range.

See Figure 13 for an example measurement set up using the 8410B with a single 8350A and 83500 series Plug-in.

The 8410B **FREQ RANGE** should be set to **AUTO**. In addition, the sweep time on the 8350A should be slow enough and/or sweep range narrow enough to insure phase locking over entire sweep range.

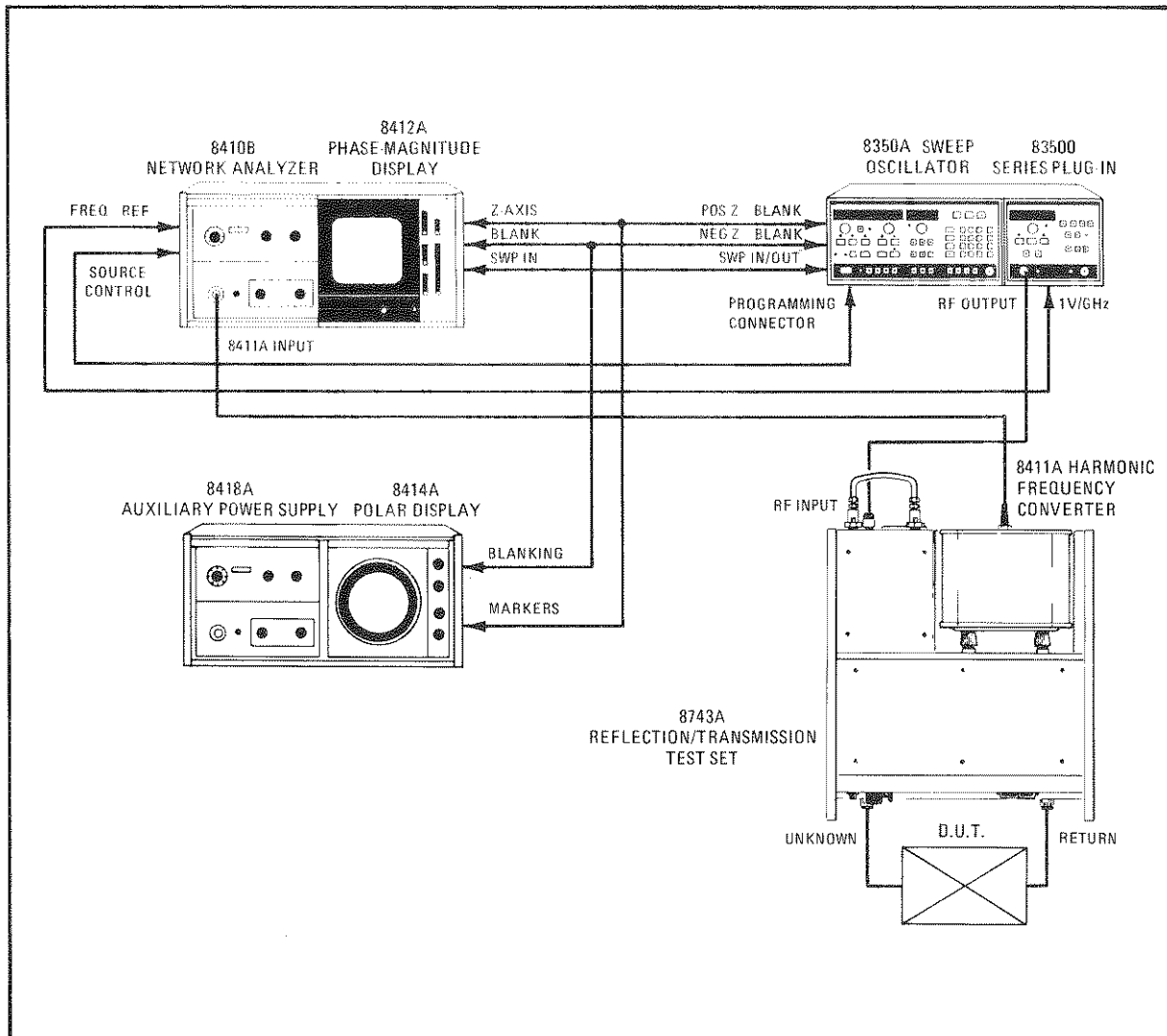

Figure 13. 8350A Connections to 8410

Notes on connections:

- **FREQ REF** output of the 83500 or 86200 series Plug-ins provides a 1-volt-per-GHz output so that the 8410B may synchronize with the sweep.
- The 8410B display units (8412A, 8414A) require that the **NEG Z BLANK** from the 8350A be used as the blanking signal.
- **POS Z BLANK** (from the 8350A line contains the Z-axis markers. This line connects to the **MARKERS** input on the 8414A Polar Display and to the **Z AXIS** input on the 8412A Phase-Magnitude Display.
- **SWEEP OUT/IN** outputs a 0 to +10 volt signal in proportion to the swept or CW frequency output. 0V corresponds to the lower frequency sweep limit; +10V to the upper. Swept RF output causes a ramp voltage out; CW output causes a dc voltage out. This connection is necessary only when using 8412A Phase-Magnitude Display.
- **8350A/8410B SOURCE CONTROL CABLE**. Provides "handshake" lines for synchronization between 8350A and 8410B (HP Part No. 08410-60146).

X-Y RECORDERS

The 8350A is equipped with outputs for controlling X-Y analog recorders.

Some of the HP X-Y recorders that may be used with the 8350A are:

7010B/7015B
7035B
7004B/7034A
7044/7045/7046/7047

The available/required signals for proper operation with an X-Y recorder are:

X INPUT – Typically SWEEP IN/OUT. Supplied by BNC connector on front or rear panel.

Y INPUT – Y axis voltage. On 8755S Frequency Response Test Set this would be AUX A for channel 1 or AUX B for channel 2. For 8410B systems, the 8412A display provides amplitude and phase outputs.

PEN LIFT – Signal line for controlling remote pen up/down. Pen up is open contact or +5 volts. Pen down (current sink) is contact closure to ground or 0 volt. Supplied by BNC connector on rear panel or pin #10 on 8350A Programming Connector.

RECORDER (SERVO) MUTE – 7044/7045/7047 only. Control line that mutes the power to the recorder servos for 100 ms at bandswitch (when using multi-band plug-ins) or designated points. Pin #1 on the 8350A Programming Connector.

PEN LIFT REQUEST – Allows a pen lift to be initiated by remote control independent of the present pen lift status. Pin #3 on the 8350A Programming Connector.

INVERSE PEN LIFT – Inverse function of Pen Lift, pin #23 on 8350A Programming Connector.

The pen lift control line is assigned to a pin on the Remote Control connector of the X-Y recorder. For a complete pin assignment listing refer to the Operating Manual for the particular X-Y recorder being used.

Pen lift pin location on X-Y recorders:

Recorder	Pen Lift Pin No.
7010B/7015B	3
7035B	18
7004B/7034A	18
7044A/45A/47A	1
7046A	34

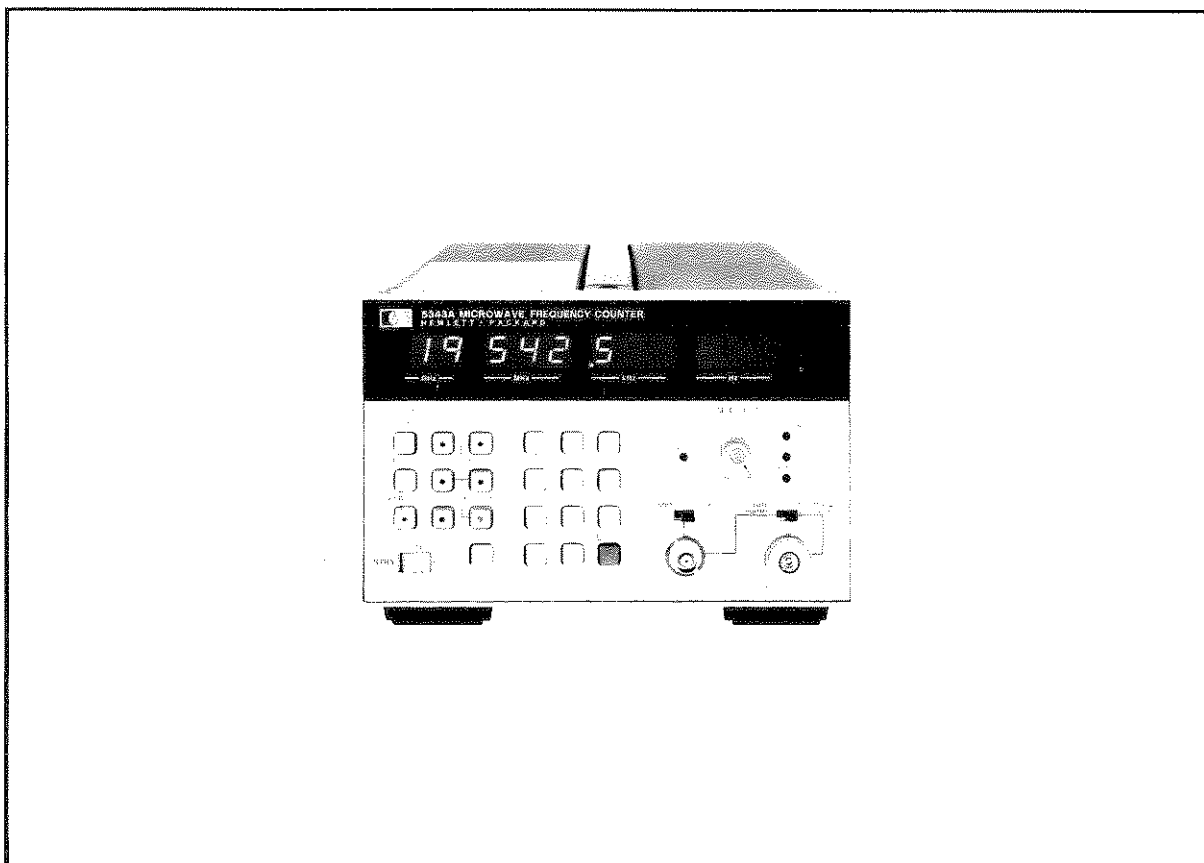

Figure 14.. 5343A Microwave Frequency Counter

5343A FREQUENCY COUNTER

The 5343A Microwave Frequency Counter can be used with the 8350A to measure frequencies in swept mode in addition to normal CW frequency measurements.

During swept operation the 5343A will stop the 8350A sweep and count a selected frequency parameter such as the START frequency, STOP frequency or any frequency markers in the sweep range. To accomplish this, the 8350A and 5343A communicate via two signal lines (Counter Trigger, Stop Sweep on the 8350A and Sweep Interface A and B on the 5343A) that enable the 8350A to externally trigger the 5343A and then allow the 5343A to stop the sweep long enough to gate and count the selected frequency parameter.

See Figure 15 for the test set up.

Measuring CW frequencies

When measuring CW frequencies the CNTR TRIG and STOP SWEEP connections are not necessary. The 5343A should be in the AUTO mode and the internal square wave modulation on the 8350A must be off.

Auxiliary Output

The auxiliary output of an RF Plug-in (if available) may be used with the 5343A. When using the auxiliary output of a multi-band plug-in such as the 83592A (0.01-20 GHz) the frequency multiplier feature of the 5343A may be used so that the proper RF frequency is displayed.

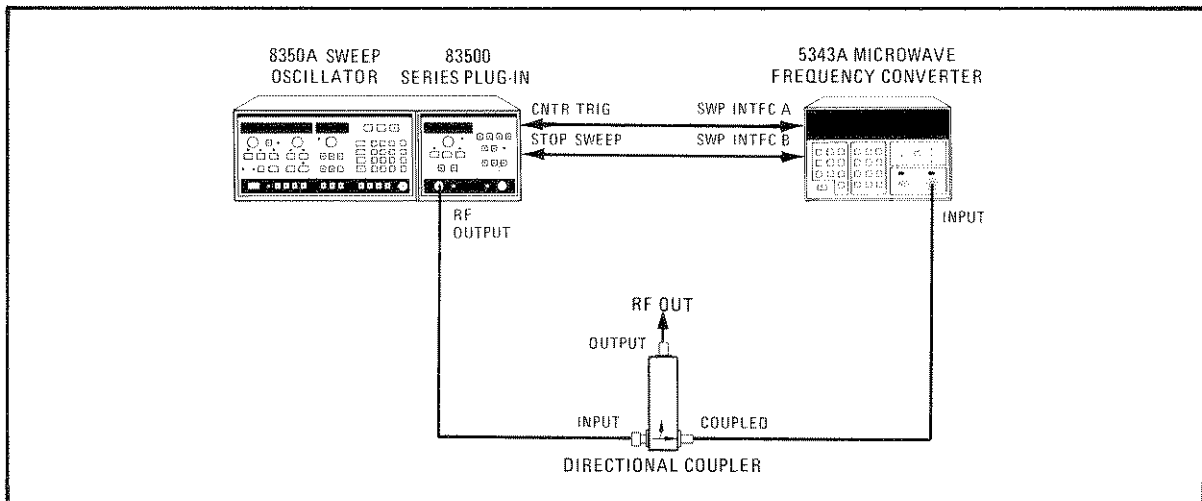

Figure 15. 5343A Test Setup

Notes on connections:

- A power splitter or directional coupler may be used as long as the input to the 5343A does not exceed +7 dBm or go below the minimum sensitivity.
- CNTR TRIG (Counter Trigger): Output for controlling the HP 5343A Microwave Frequency Counter. This allows a frequency count of the selected marker, START or STOP frequency of the present sweep. Connects to the SWP INTFC A (sweep interface, on the rear panel of the 5343A) to externally trigger the counter.
- STOP SWEEP: Input for stopping the progress of the forward sweep. When connected to the SWP INTFC B (sweep interface, on the rear panel of the 5343A) the 5343A stops the sweep long enough for the counter to gate and measure the selected frequency marker, START or STOP frequency. If the internal modulation on the 8350A is on, it is momentarily disabled so that the counter may measure the frequency.

To measure a START, STOP, or marker frequency during a sweep:

5343A: Set to AUTO, SWP M and set desired frequency resolution. Set the rear panel ACQ TIME switch to MED or FAST.

8350A: Select the frequency parameter to be measured by pressing the appropriate key, START, STOP, or any marker M_n (where n=1, . . . ,5) and then press SHIFT M₂

If the sweep setting is changed or it is desired to exit this mode, disable the 5343A by pressing SHIFT M₃ on the 8350A front panel.

Example:

To measure the START frequency.

1. Connect equipment as shown in Figure 15. Set the 5343A to AUTO, SWP M and set desired frequency resolution.
2. Press the 8350A INSTR PRESET START SHIFT and M₂ keys. The 5343A will temporarily stop the sweep, measure the frequency and display it at the desired resolution.

APPENDIX 1 REAR PANEL CONNECTIONS.

For a diagram of the rear panel see Figure 16.

POS Z BLANK. Positive Z axis blanking signal. Supplies a rectangular pulse of approximately +5V into 2500 ohms during the retrace and bandswitch points of the RF output. Also supplies a -5V (-8 volts for active marker) pulse when the RF is coincident with a marker frequency if intensity markers are selected.

NEG Z BLANK. Negative Z-axis blanking signal. Supplies a negative rectangular pulse (-5V into 2500 ohms) during the retrace and bandswitch points of the RF output.

PEN LIFT. Output to control the pen lift function of an X-Y recorder. Maximum pen-up level is +40V and maximum pen-down sink current is 500 mA (at +0.7V).

SWEEP OUT/IN. Wired in parallel with sweep out/in BNC connector on front panel. See Display Functions Control group for a description.

CNTR TRIG. Counter Trigger (HP 5343A Frequency Counter only). Output for controlling the external trigger input of the HP 5343A frequency counter.

STOP SWEEP. Input for stopping the progress of a forward sweep. When input is 0 to 0.8 volt, sweep is stopped - RF output is a constant CW frequency. Sweep continues when input voltage returns to greater than 2 volts or open circuit. Usable with the HP 5343A Frequency Counter and CNTR TRIG to select and measure frequency points along the sweep.

FM INPUT. Input for frequency modulation or phase lock error signal for the plug-in. This input is passed through to the plug-in and processed by the plug-in only. See plug-in specifications for frequency deviation and sensitivity.

AM INPUT. Input for external amplitude modulation of the plug-in. This input is passed through to the plug-in. See plug-in specifications for amplitude input range.

ALT SWP INTERFACE. Connects via cable HP Part No. 8120-3174 to 8755C to provide Alternate Sweep function.

PROGRAMMING CONNECTOR. See Figure 16 for pin designation.

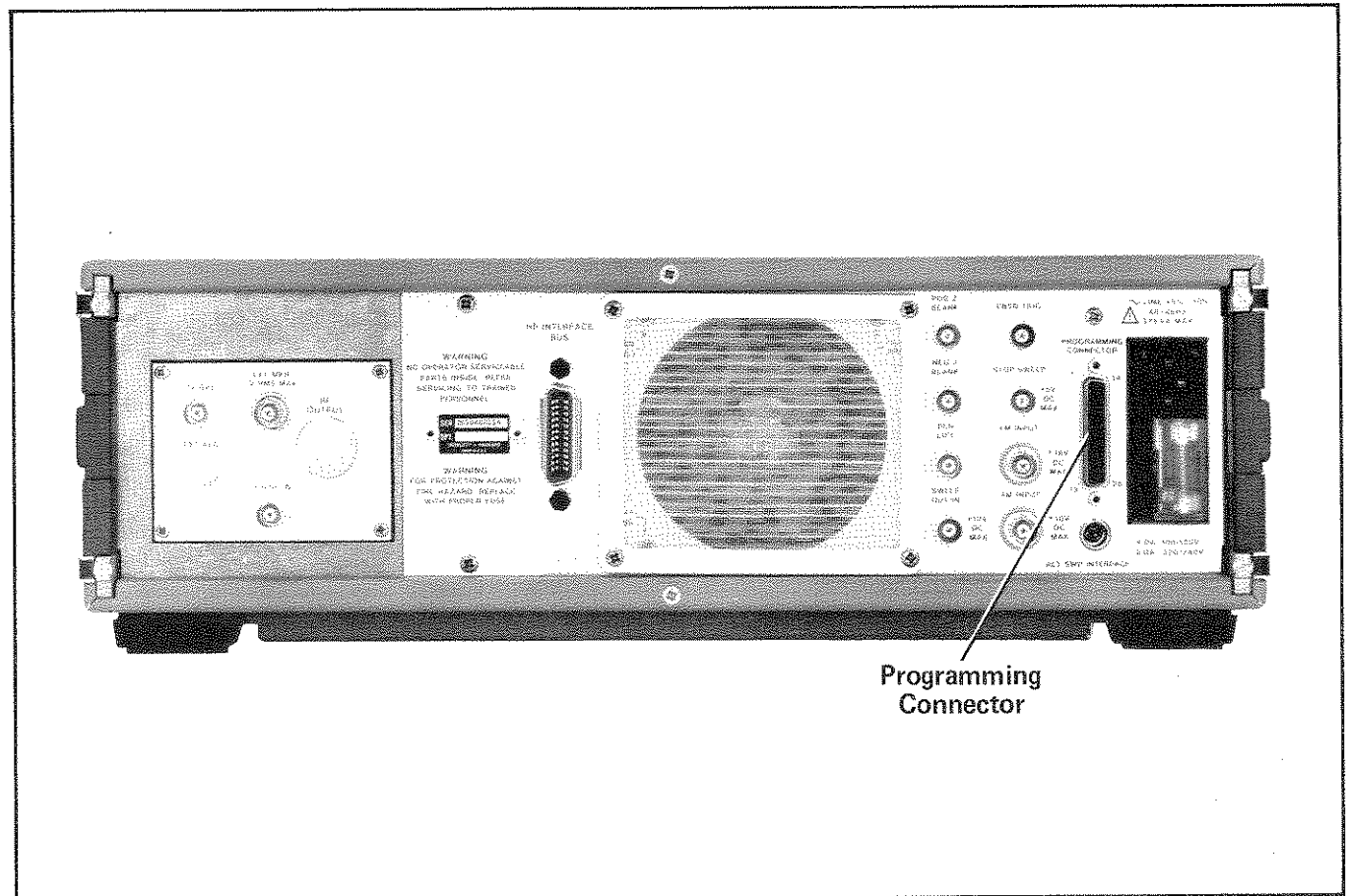

PROGRAMMING CONNECTOR

Pin No.	Description	Pin No.	Description
1	Marker Pulse	15 -	Marker Pulse Request (I)
2 -	Marker Pulse	16 -	Retrace (O)
3 -	Pen Lift Request (I)	17 -	Alternate Sweep (O)
4 -	Sweep Alternate (O)		Enable
5 -	Stop Fwd. Sweep Request (I)	18 -	Stop Sweep Request (I)
6	+5 Volt (100 ma MAX) (O)	19	Digital Ground (I/O)
7 -	RF Blanking (O)	20 -	Blanking Pulse Request (I)
8 -	RF Blank Request (I)	21 -	Counter Trigger (O)
9 -	Ext. Trigger Input (I)	22 -	Step Up (I)
10 +	Pen Lift (O)	22 -	Advance
11 -	Recorder Mute (O)	23 -	Inverse Pen Lift (O)
12	- (O)	24 +	8410 Ext. Trigger (O)
13	- (O)		
14 -	Blanking (O)	25	-

- Negative Logic (True is logical "0") (I) Input
 + Positive Logic (O) Output

Figure 16. Rear Panel Connections

APPENDIX 2:**86200 SERIES PLUG-INS WITH 11869A ADAPTER**

Figure 17. Connecting 11869A Adapter to 86200 series Plug-in

Although designed for the 8620 Sweep Oscillator, the 86200 series RF Plug-ins can be used in the 8350A Sweep Oscillator with the addition of the 11869A Adapter.

The 11869A Adapter provides the electrical and mechanical interface between the 8350A and an 86200 series Plug-in. A switch on the 11869A allows the user to select the appropriate interface code (from the code listing on the adapter) so that an 86200 series Plug-in can be used in the 8350A.

All of the standard performance and control of the 8350A is available when using an 86200 Plug-in with the 11869A Adapter. However, plug-in functions (e.g. output power, RF on/off, plug-in markers) will not be programmable and will not respond to keyboard and step keys. On the rear panel of the 11869A Adapter are several hole plugs that allow connections to be made to the back panel of the plug-in. 11869A Option 004 provides two semi-rigid cables to allow connection of 86200 series rear panel RF output to 11869A rear panel.

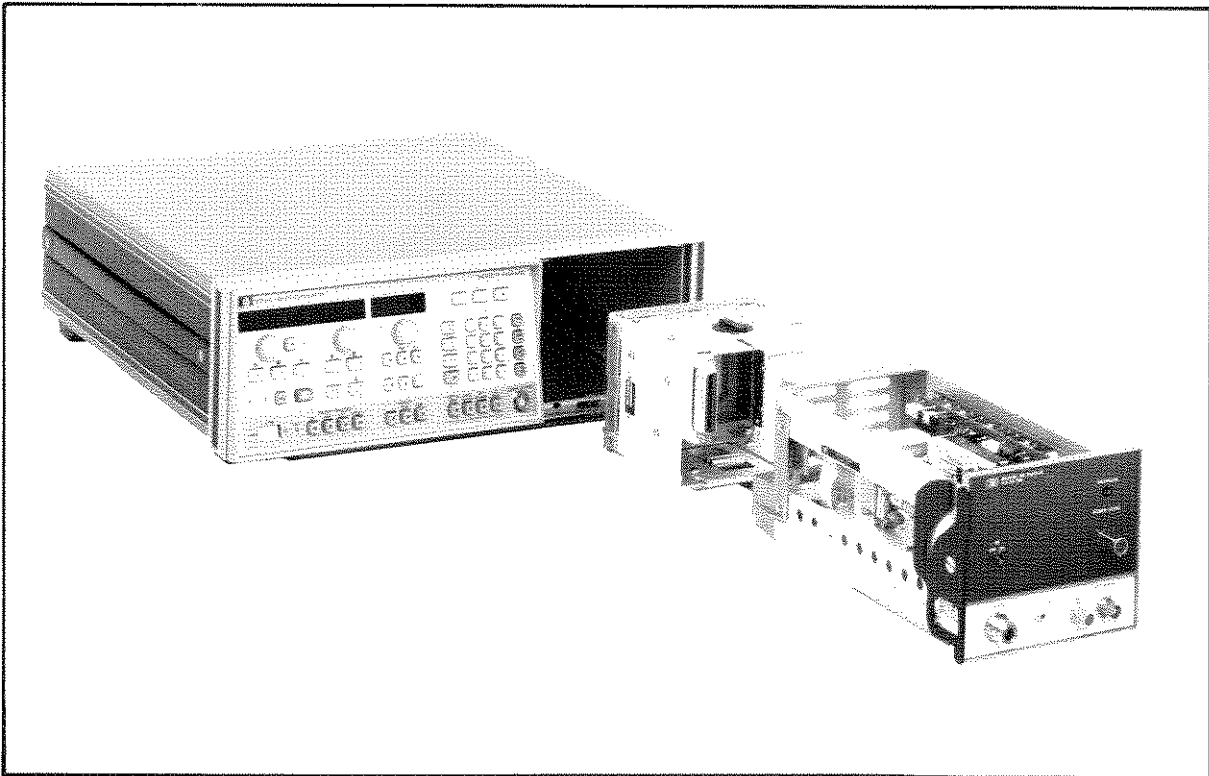
Special Plug-ins: (Plug-ins with Option HXX)

When using 86200 series Plug-ins that have been factory modified for a non-standard frequency range, a PROM obtained from the factory must be used in the 11869A Adapter. The PROM is inserted in the 16-pin socket on the PC board of the adapter and is needed for proper interfacing and controlling of a non-standard plug-in.

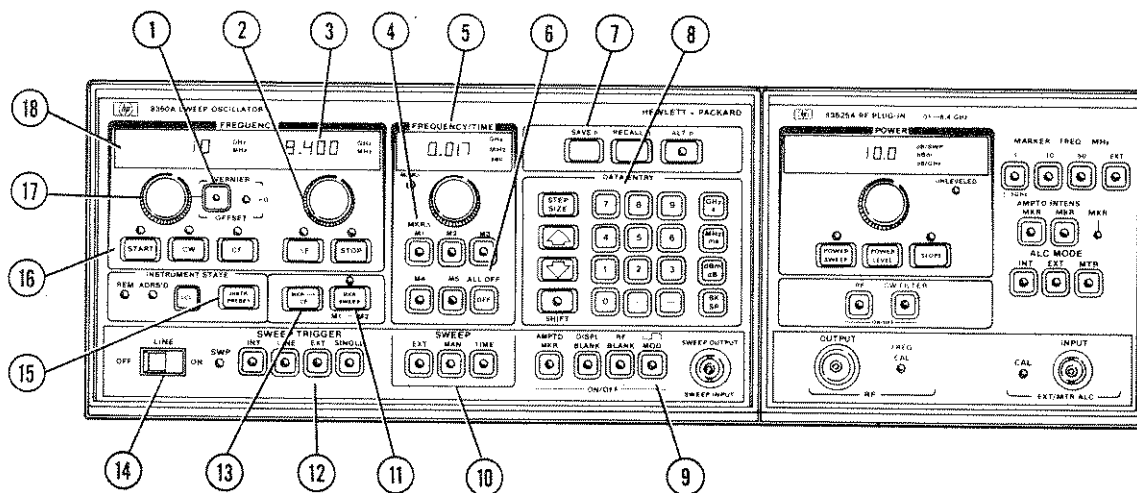

APPENDIX 3 FRONT PANEL CONTROLS SUMMARY

1. **Vernier/Offset.** Vernier function offsets sweep ranges, CW or CF frequencies. $\neq 0$ lamp lit when non-zero offset or vernier present.
2. **Right Frequency Control.** Adjusts ΔF or STOP frequency.
3. **Right Frequency Display.** Displays STOP or ΔF frequency in GHz or MHz.
4. **MKR- Δ .** Allows user to display frequency difference between any two markers and intensifies the appropriate portion of the display.
5. **Frequency/Time Display.** Display Marker or manual sweep frequency in GHz or MHz. Sweep Time in seconds and HP-IB address.
6. **Markers.** Controls the five independent, mainframe supplied frequency markers.
7. **Save n/Recall n/Alt n.** Can save and recall up to nine different settings.
8. **Data Entry Keyboard.** Can enter exact values or step sizes for most sweep parameters via the keyboard.
9. **Output Controls.** Can control marker display mode, RF and display blanking and internal square wave modulation (of the RF output).
10. **Sweep Mode.** Selects External, Manual, or Timed sweep mode.
11. **MARKER SWEEP.** Causes Marker 1 frequency to temporarily become start of sweep, Marker 2 frequency to become stop of sweep.
12. **Sweep Trigger.** Determines how sweep will trigger.
13. **MKR-CF.** Causes center frequency of sweep to be shifted to the frequency of the currently active marker.
14. **Line switch.** Turns on/off 8350A mainframe and plug-in.
15. **Instrument Preset.** Selects a pre-determined instrument state.
16. **START/CF/CW/ ΔF /STOP Sweep mode keys.** Selects mode of output and display.
17. **Left frequency Control.** Adjusts START, CW, CF, VERNIER or OFFSET.
18. **Left Frequency Display.** Displays START, CW, CF, VERNIER or OFFSET frequency in GHz or MHz, depending on mode selected, plus self test error codes.

Figure 18. Front Panel Controls

Introductory Operating Guide for the HP 8350A Sweep Oscillator with the HP 9825 Desktop Computer

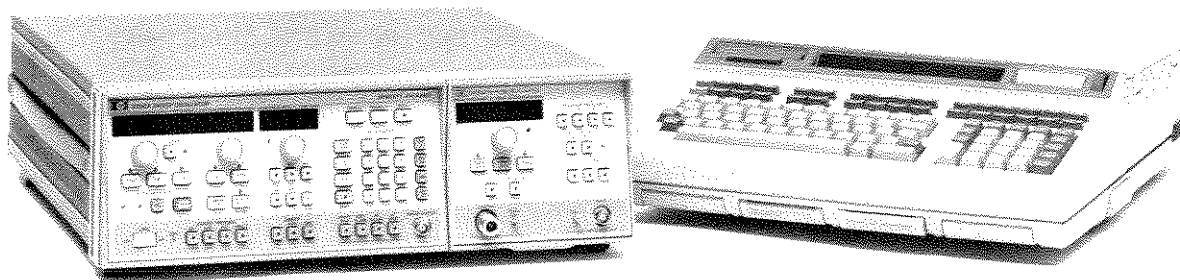

INTRODUCTION

This programming note is a guide to the remote operation of the HP 8350A Sweep Oscillator and appropriate HP 83500 Series Plug-in using the HP 9825 Desktop Computers. Included in this guide are the system connections for remote operation and several example programs with descriptions of each step.

The 8350A is fully compatible with the Hewlett-Packard Interface Bus (HP-IB). When used with a controller such as the 9825, complete control of the sweep mode, frequency limits, frequency markers, power level, and all other front panel controls can be achieved.

REFERENCE INFORMATION

For further information on the HP Interface Bus, the following references should prove helpful:

1. Condensed Description of the Hewlett-Packard Interface Bus (HP Part Number 59401-90030).

2. HP-IB Programming Hints for Selected Instruments/9825 (HP Part Number 59300-90005).

Complete reference information on the 8350A can be found in the 8350A Sweep Oscillator Operating and Service Manual (HP Part Number 08350-90001). For information on operating the 9825B the following references are available:

1. 9825B/T Operating, Programming and Control Manual (HP Part Number 09825-90200).
2. 9825B/T I/O Programming Manual (HP Part No. 09825-90210).

If using the 9825A:

1. 9825A/S Operating and Programming Manual (HP Part No. 09825-90000).
2. 9825A/S General I/O Programming Manual (HP Part No. 09825-90024).
3. 9825A/S Extended I/O Programming Manual (HP Part No. 09825-90025).

EQUIPMENT REQUIRED

To perform all the example programs described in this programming note, you will need the following equipment and accessories:

1. HP 8350A Sweep Oscillator with any HP 83500 Series Plug-in. Note that an HP 86200 Series Plug-in with the HP 11869A Adapter can be used but all references to power level and power control are not applicable and some functions do not have their full capability.
2. HP 9825B/T Desktop Computer (all ROM's are internal)

or

HP 9825A/S Desktop Computer with:

- a. HP 98210A String-Advanced Programming ROM
- b. HP 98213A or 98214A or 98216A General I/O-Extended I/O ROM

3. HP 98034A HP-IB Interface Card/Cable.

NOTE

The following equipment is not required for the programs to function but rather for a visual display of the 8350A functions.

4. HP 8755S Frequency Response Test Set with:
 - a. HP 8755C Swept Amplitude Analyzer
 - b. HP 180TR or 182T Display Unit
 - c. HP 11664A or 11664B Detector
 - d. Two 120 cm BNC cables (HP 11170C variety) or any appropriate oscilloscope with Detector (Crystal/Schottky), Attenuator and BNC cabling.
5. Any test device over the frequency range of the 83500 Series Plug-in.

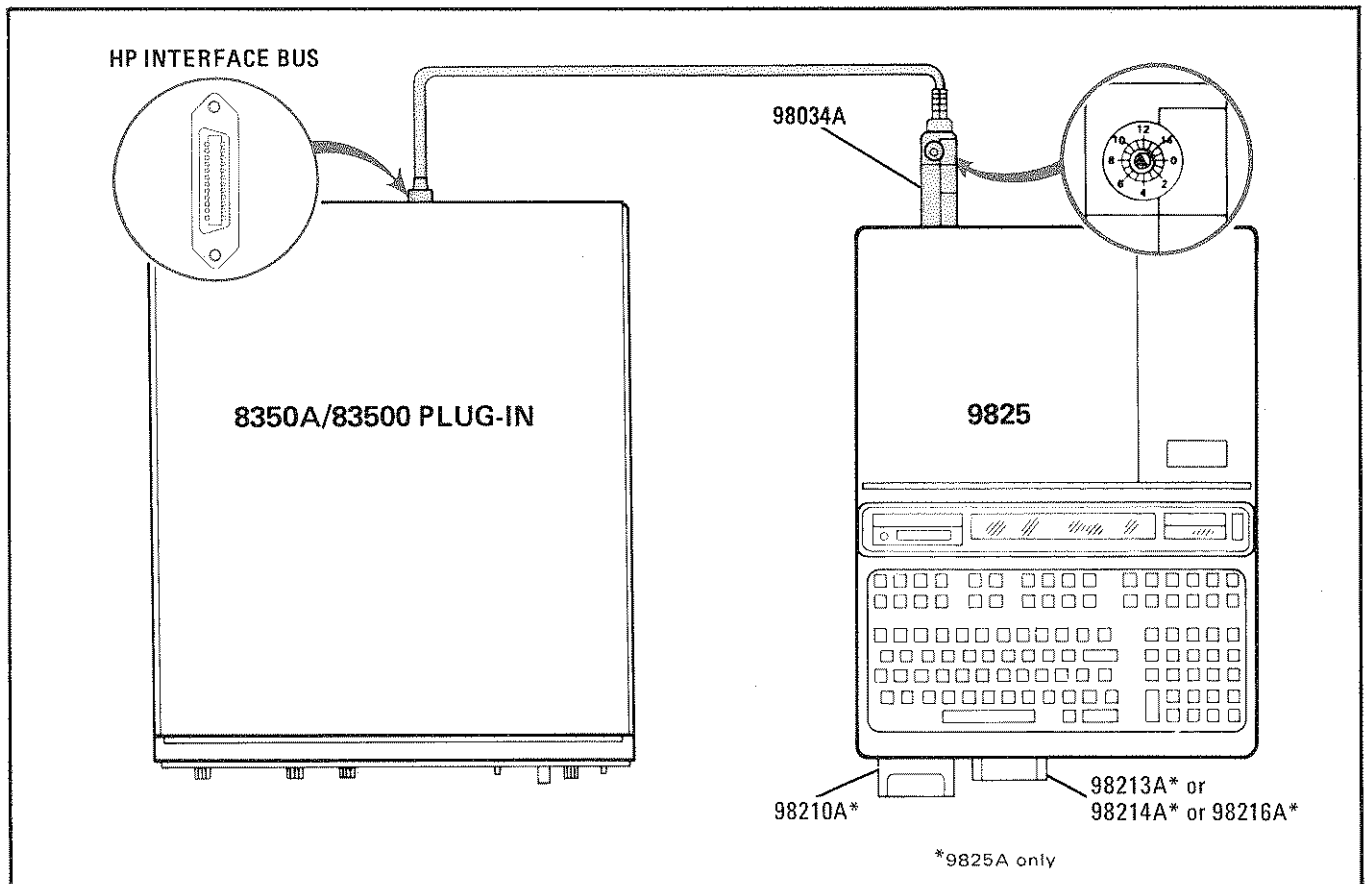

Figure 1. System Connection

SET-UP

Figure 1 shows the system connection and switch settings for the 98034A Interface and the 9825 Desktop Computer. The following procedure completes the setup:

1. Turn off the power to the 9825.
2. For the 9825 Desktop Computer verify that the ROMS's are installed. If using a 9825A, then check the front panel slots. If using the 9825B these ROM's are internal and may have been disabled by an internal switch.
3. Install the 98034A Interface Card into one of the rear panel slots of the 9825.
4. Verify that the rotary switch on top of the 98034A is set to "7". If not then set it to "7" since this is the select code for the interface card for all programs found within this guide.
5. Connect the 24-pin HP-IB connector of the 98034A to the rear panel HP-IB connector of the 8350A. This connector is tapered to insure proper connection.

CAUTION

Do not attempt to connect black metric threaded screws on one connector with silver English threaded nuts on another connector, or vice-versa, as damage may result. A metric conversion kit which will convert one cable and one or two instruments to metric hardware is available by ordering HP Part No. 5060-0138.

6. All programs within this guide expect the 8350A HP-IB address to be decimal 19. The 8350A HP-IB address switches are located inside the instrument and are factory preset to decimal 19. The present HP-IB address can be found by executing the front panel 'Set HP-IB Address' function by:

Press **SHIFT** **LCL**

The FREQUENCY/TIME display will indicate the present decimal address. If the number displayed is not 19 then reset it by:

Press **1** **9** **GHZ**

This HP-IB address will remain in effect until the instrument is powered off when the internal address switches are read at power on (unless 8350A Option 001 Non-volatile Memory is

used). Since Example 4 requires the 8350A to be powered off and then on, the internal address switches should be reset to 19 if necessary.

CHECK-OUT

Turn on the 9825 and the 8350A. The 9825 should have a "lazy T" (┌—) in the LED display and the 8350A should undergo an internal self test. The 8350A turn-on self test consists of the red LED numeric displays being blanked and all yellow indicator LED's on, then the 8350A sweep controls are set to the instrument preset state: Start/Stop Sweep over the entire plug-in frequency range, fastest sweep time for plug-in used (typically 10 milliseconds), and maximum leveled output power for the plug-in. If the 8350A fails the power-up self test an error message will be displayed in the far left LED display. Check section 8 of the 8350A Operating and Service Manual for error message decoding.

To verify that the HP-IB connections and interface are functional perform the following on the 9825:

1. Press **RESET**
2. Type 'rem 719'
3. Press **EXECUTE**

Verify that the REMote light on the 8350A is lit. If this fails, verify that the 98034A select code switch is set to "7", the 8350A address switches are set to "19", and the interface cable is properly connected.

If the 9825 display indicates an error message, it is possible that the above remote message was typed in incorrectly or the ROM's are not properly installed. If the 9825 accepts the remote statement and the "lazy T" appears in the display but the 8350A REMote light does not turn on, you could have a defective 98034A or 8350A. Perform the operational checks as outlined in the respective Operating and Service Manuals to find the defective device.

PROGRAMMING EXAMPLES

The following sample programs show the various ways of controlling the 8350A. In remote control situations the 8350A Sweep Oscillator can interact with the system HP-IB controller in two basic ways:

1. "Listen Mode": The 8350A listens to the control commands as to modifying the present instrument state. This effectively commands the 8350A

to do a specific event much like setting a front panel function.

2. "Talk Mode": The 8350A informs the controller of the present instrument state with a numeric value or a string of characters. This effectively allows the user to interrogate or learn any 8350A function.

Each programming example is structured using the following format:

1. A general description of the functions exercised.
2. A program listing.
3. An explanation of each program line.
4. Detailed instructions for operating the program.

A complete summary of all the 8350A HP-IB program codes is provided at the end of this note.

EXAMPLE PROGRAM 1: Remote, Local, Local Lockout, and Instrument Preset

Before programming the 8350A for different sweep functions, the user should be aware of the extent of remote control that can be used. The Remote Enable ('rem') command sets the 8350A into remote control from the local (manual) mode. In remote the 8350A will perform only as its functions are programmed. However if the LCL button is pressed, the 8350A will return to the remote state to local control. To prevent this from occurring the Local Lockout (llo) command disables all front panel controls, specifically the "Local" key. The Go To Local (lcl) command will return the 8350A to front panel control thereby removing it from the remote and local lockout modes. Note that the above remote and local commands are different from the general HP-IB bus local and remote commands (lcl 7 and rem 7). Finally, in remote control it is periodically desirable to reset the 8350A to a pre-defined state, this is achievable with the Instrument Preset function.

PROGRAM 1
0: rem 719;dsp "Remote";stp 1: rem 719;llo 7;dsp "Local Lockout";stp 2: lcl 719;dsp "Local";stp 3: wrt 719;"IP";stp *21323

PROGRAM 1 EXPLANATION

- Line 0: Sets 8350A to remote, the 9825 displays "Remote", then stops program execution.
- Line 1: Sets 8350A to remote and local lockout, the 9825 displays "Local Lockout", then stops program execution.
- Line 2: Sets 8350A to local, the 9825 displays "Local", then stops program execution.
- Line 3: Sets 8350A to remote and performs an Instrument Preset, then stops program execution.

To verify and investigate the different remote modes perform the following:

1. Press **RESET ERASE A EXECUTE** on the 9825. This erases the program memory.
2. Press **INSTR PRESET** on the 8350A.
3. Type in the above program.
4. Press **RUN** on the 9825.
5. With the 9825 displaying "Remote", verify that the 8350A REMote light is lit. From the front panel, attempt to change the start frequency and verify that this is impossible. Verify that the Instrument Preset key and all other keys except LCL are disabled. Now press the **LCL** key and verify that the 8350A REMote light is off and that you can modify any of the sweep functions.
6. Press **CONTINUE** on the 9825. With the 9825 displaying "Local Lockout" verify that the 8350A REMote light is again lit. Again attempt to change the start frequency and perform an instrument preset. Verify that this is impossible. Now press the **LCL** key and verify that still no action is taken.
7. Press **CONTINUE** on the 9825. With the 9825 displaying "Local" verify that the 8350A REMote light is off. Also verify that all sweep functions can now be modified via the front panel controls.
8. Press **CONTINUE** on the 9825. Verify that the 8350A has undergone an Instrument Preset and the REMote light is on. The Write ('wrt 719') statement does two things, one it performs a 'rem 719', and second it passes data to the 8350A.

Note that the 8350A LCL key produces the same result as programming 'lcl 719' or 'lcl 7'. Be careful as the latter command places all instruments on the HP-IB in local state as opposed to the 8350A alone.

EXAMPLE PROGRAM 2: Programming Functions

To program any function on the 8350A the controller must pass specific program codes and data to the sweeper. The statement that allows this is the Write (wrt) statement. The alphanumeric data string of the write statement can be a concatenation of character strings and/or variables. The data can be specific codes, free field formatted data, or reference a specific format (fmt) statement. For example, to program the CW Frequency (CW), one program code sequence is "CW", followed by the frequency in GHz, then "GZ". If the frequency is to be 7.555 GHz, then the string "CW7.555GZ" will suffice. However if the frequency were to change then a variable 'F' could indicate the frequency in GHz and the program string could be "CW",F,"GZ". Using a format statement also allows a specific number of digits to be passed, thereby avoiding any unexpected round off errors.

NOTE

This program expects an 83500 Series Plug-in that covers the frequency 7.555 GHz. If using a plug-in that does not cover this frequency range then the value in line 1 should be changed to an appropriate value.

```
PROGRAM 2
0: wrt 719,"IP";fxd 2
1: wrt 719,"CW7.555GZ";dsp
   "CW = 7.555 GHz";stp
2: ent "CW (in GHz) = ?";F
3: prt "CW = ",F," GHz"
4: wrt 719,"CW",F,"GZ";sto -2
5: fmt 1,"CW",f6.3,"GZ"
6: wrt 719.1,F;sto -4
*19247
```

PROGRAM 2 EXPLANATION

- Line 0: Puts the 8350A into a predefined state via instrument preset, then fixes data to 2 decimal places.
- Line 1: Puts the 8350A in CW mode and programs a CW frequency of 7.555 GHz, the 9825 displays "CW = 7.555 GHz", then stops program execution.
- Line 2: The 9825 displays "CW (in GHz) = ?". The user is prompted to input a new CW frequency value which is stored in the variable 'F'.
- Line 3: Print on the internal strip printer the programmed CW frequency.

- Line 4: Program the CW frequency using the default data format, then go to line 2.
- Line 5: Format statement #1 is set up for programming the CW frequency with a 1 MHz resolution.
- Line 6: Program the CW frequency via format statement #1, then go back to line 2.

The equipment setup is the same as the previous example. Reset the 9825, erase the 9825 memory, then type in the above program. Then perform the following:

1. Press **RUN** on the 9825. The 9825 displays "CW = 7.555 GHz". The 8350A changes from the instrument preset state of Start/Stop sweep to a CW frequency of 7.555GHz.
2. Press **CONTINUE** on the 9825. The 9825 now displays "CW (in GHz) = ?". Type in a new CW frequency (value in GHz), then press **CONTINUE**.
3. The 8350A will be programmed to the new CW frequency with the new value printed on the internal strip printer. The program jumps back to step 2. above.

When inputting the CW frequency try several values, each with a different number of digits after the decimal point. Notice that the 8350A displays the frequency to 3 decimal places (1 MHz frequency resolution). Values with better than 1 MHz frequency resolution are rounded to the nearest MHz by the 8350A. However when the 9825 is reset all numeric output data defaults to the 'fxd 2' or fixed 2 decimal places format. Thus the 9825 rounds the desired frequency to the nearest 10 MHz. To change this free-field format to more decimal places change the fixed format statement in line 0 to 'fxd 5' then re-run the program. Another approach is to utilize the format statement to set the desired number of decimal places. To use the format statement in the program perform the following on the 9825:

Press **STOP** **FETCH** **4** **EXECUTE**
then **DELETE** **LINE**

This should delete line 4 from program #2 and allow the use of lines 5 and 6 instead. Run the modified program again and use the same steps for operation as before. Now if the value inputted has a frequency resolution greater than 1 MHz the 9825 does the rounding instead of the 8350A. This is the preferred

programming approach. Change the format statement for 10 MHz frequency resolution and verify the results from the 8350A frequency display.

Since a device select code address can be a variable via the Device ('dev') statement, verify that this can be used in the modified or original program #2 by doing the following:

1. Insert before Line 0 a new line using the 'dev' command by:

Press **STOP** **FETCH** **0** **EXECUTE**
 Type 'dev "SWP",719'
 Press **INSERT** **LINE**

2. Modify the write statement(s) by fetching the necessary lines, then change the 'wrt 719' to 'wrt "SWP"' and 'wrt 719.1' to 'wrt "SWP.1"'.
3. Re-run the modified program using the same operation steps as above.

EXAMPLE PROGRAM 3: Setting Up A Typical Sweep

Typically the sweeper is programmed for the proper sweep frequency range, sweep time, power level, and marker frequencies for a test measurement. This program sets up the sweeper for a general purpose situation using several dedicated format statements. Note that not all parameters need to be reprogrammed every time.

NOTE

This program expects an 83500 Series Plug-in that covers the frequency range of at least 3 to 7 GHz. If using a plug-in with a different frequency range, change the values in lines 5, 8, and 9, to the appropriate values. If using an 86200 Series Plug-in, then do not enter Line 6.

PROGRAM 3	
0:	fmt 1, "FR", f6.3, "GZFB", f6.3, "GZ"
1:	fmt 2, "ST", f5.0, "MS"
2:	fmt 3, "M", f1.0, f6.3, "GZ"
3:	fmt 4, "PL", f6.2, "DM"
4:	wrt 719, "IPMD1"
5:	wrt 719.1, 3, 7
6:	wrt 719.4, 10
7:	wrt 719.2, 50
8:	wrt 719.3, 1, 4
9:	wrt 719.3, 2, 6; stp
	*20341

PROGRAM 3 EXPLANATION

- Line 0: Format statement for setting the Start and Stop Sweep frequencies in GHz.
- Line 1: Format statement for setting the Sweep Time in milliseconds.
- Line 2: Format statement for setting a Frequency Marker by marker number and frequency in GHz.
- Line 3: Format statement for setting the Output Power Level in dBm.
- Line 4: Preset the sweeper to a known state via instrument preset and enable the internal 27.8 kHz Square Wave Amplitude Modulation.

- Line 5: Set a Start/Stop Sweep of 3.0 to 7.0 GHz.
- Line 6: Set the Sweep Time to 50 msec.
- Line 7: Set the Output Power Level to +10 dBm.
- Line 8: Set Marker #1 to 4 GHz.
- Line 9: Set Marker #2 to 6 GHz, then stops program execution.

Set up the equipment as shown in figure 2 by adding the 8755C, the 180TR or 182T, the 11664, and a test device like a 4 to 6 GHz Bandpass Filter. It is important that the two rear panel connections from the 8350A to the 8755C/182T are made for a proper CRT display. For the example measurement set the following front panel controls:

On the 8755C:

Channel 1:
 Display OFF (press all the display push buttons so that they are out)

Channel 2:
 Display B
 dB/DIV 10 dB
 Reference Level -10 dB
 Reference Level Vernier OFF

On the 182T or 180TR:

Magnifier X1
 Display INT

After connecting the equipment: reset the 9825, erase the 9825 memory, then type in the above program. Then run the program. The 8350A will initially undergo an instrument preset which will set the proper power leveling mode and sweep blanking signals. Since the 8755C requires the RF signal to be modulated at a 27.8 kHz rate, the internal amplitude modulation is enabled. If using a 4 to 6 GHz Bandpass Filter as the test device, the CRT display should reflect the filter transmission

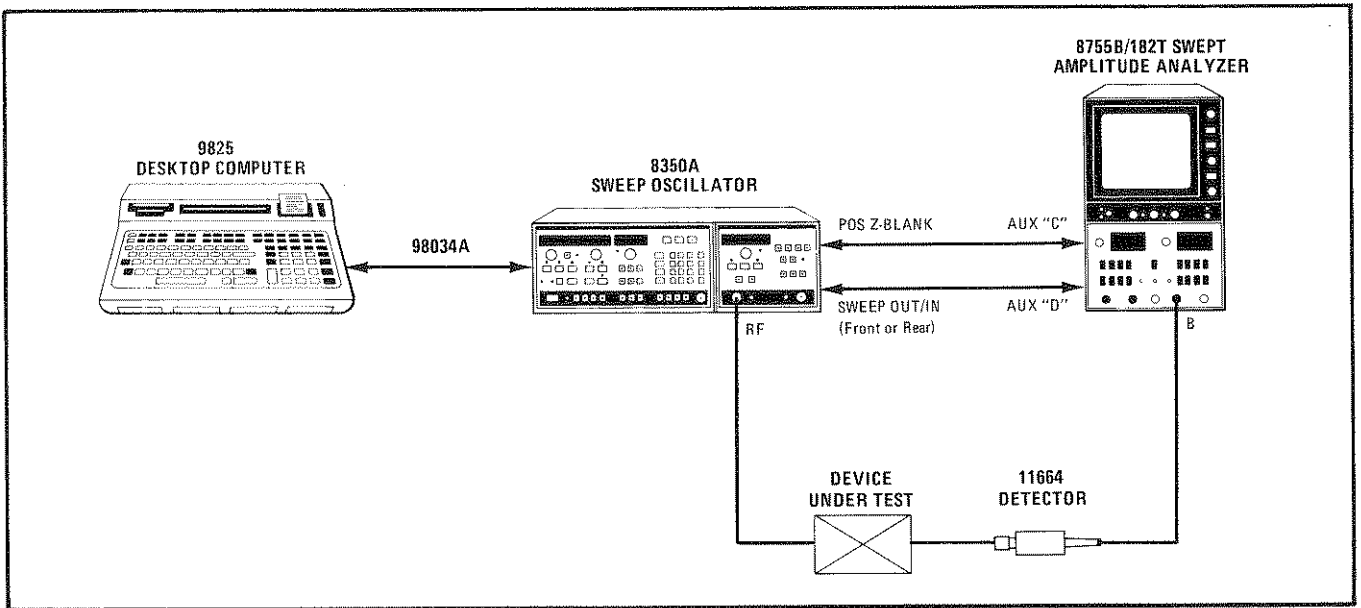

Figure 2. Equipment Setup For Program 3

response over the 3 to 7 GHz range. Two frequency markers of the Z-Axis Intensity dot variety are set to 4 and 6 GHz, hopefully within the passband or near

the 3 dB points. The setup can be modified by changing the values in lines 5, 6, 7, 8, and/or 9, then rerun the program.

EXAMPLE PROGRAM 4: Learning An Instrument State

Being able to save a specific instrument state is helpful when it is needed several times in a test or measurement procedure. The user could save the instrument state by manually logging the important sweep parameters such as frequency range, power level, ALC modes, etc., then re-inputting them at the appropriate time. A somewhat simpler approach is to save the instrument state in one of the 8350A internal storage registers, then recall it when needed.

However, this is not a permanent solution unless the 8350A Non-volatile Memory option (Option 001) is used. A more permanent solution is to use the Output Learn String function of the 8350A so that the 9825 can learn then store a data string that describes the present instrument state on a tape cartridge or in its' internal memory. Once an instrument state is stored or learned, the 8350A can then be restored to that state using the Input Learn String function. The power of these instrument Learn/Teach functions are demonstrated by the following program using the 9825 fast data transfer function.

```

PROGRAM 4
0: dim A$[116]
1: buf "Learn",A$,3
2: wrt 719,"IPMD1";!cl 719;stp
3: wrt 719,"OL"
4: tfr 719,"Learn",90
5: if rds("Learn")=-1;sto +0
6: A$[1,90]->A$
7: stp
8: wrt 719,"IL"&A$
9: stp
*23021

```

PROGRAM 4 EXPLANATION:

- Line 0: Set the length of the A\$ string to 116 characters.
- Line 1: Set up an I/O buffer named "Learn" that uses the string A\$ for data storage. The buffer type selected is a byte data, fast read/write buffer.
- Line 2: Set the 8350A to a predefined state via instrument preset and enable the square wave modulation. Return the 8350A to local control, then stops program execution.

- Line 3: Program the 8350A to output the Learn String.
- Line 4: Transfer the Learn String information into the 9825 data buffer specifying to transfer only 90 characters.
- Line 5: Check the status of the buffer to determine if the transfer is complete. If it is not, then keep checking the buffer status.
- Line 6: Extract the Learn String information from the buffer by removing the buffer pointers and re-save only the Learn String in A\$.
- Line 7: Stops program execution.
- Line 8: Program the 8350A to accept a new Learn String, then send the new Learn String to the 8350A.
- Line 9: Stops program execution.

Set up the equipment as in example 3 using the CRT display to verify the sweep settings. Note that the original equipment setup can also be used with the 8350A front panel indicators used for verification. Reset the 9825, erase the 9825 memory, then type in the above program. Run the program. The 8350A will undergo an instrument preset, enable the square wave modulation, then return to local front panel control. Then perform the following:

1. Adjust the 8350A to a preferred instrument state, then press **CONTINUE** on the 9825.
2. Turn the 8350A line power off. Wait five seconds then turn the 8350A power back on. Press **INSTR PRESET** on the 8350A.
3. Press **CONTINUE** on the 9825. Verify on the CRT display and/or the 8350A that the original instrument state has been restored.

EXAMPLE PROGRAM 5: Interrogating The Present Value Of A Function

While the 8350A Learn String enables the user to completely save a string of characters that define the present instrument state, the information is densely packed and encoded to save memory space. If the user wishes to determine the actual value of a specific parameter, say the Start Frequency, it would require a tedious process to extract a numeric value from several characters within the Learn String. An easier approach is to use the Output Interrogated Parameter function of the 8350A. With this function the 9825 instructs the 8350A to output the present numeric value of a specified function. Any function that has a numeric value associated with it (except Step Size) can be interrogated. Note that if the parameter is not presently active, the 8350A uses a computed value or its previous active value. The following program demonstrates the capability of the interrogate function.

to local control, then stop program execution.

- Line 1: Program the 8350A to output the present value of the Start Frequency. Read the value into the 9825 and store it in the variable 'A'.
- Line 2: Print on the internal strip printer the present value of the Start Frequency in MHz.
- Line 3: Program the 8350A to output the present value of the Stop Frequency. Read the value into the 9825 and store it in the variable 'B'.
- Line 4: Print on the internal strip printer the present value of the Stop Frequency in MHz.
- Line 5: Program the 8350A to output the present value of the Sweep Time. Read the value into the 9825 and store it in the variable 'T'.
- Line 6: Print on the internal strip printer the present value of the Sweep Time in milliseconds.
- Line 7: Stops program execution.

Set up the equipment as in example 3 using the analyzer's CRT display to verify the sweep settings. Note that the original equipment setup can also be used with the 8350A front panel indicators used for verification. Reset the 9825, erase the 9825 memory, then type in the above program. Run the program. The 8350A will undergo an instrument preset, enable the square wave modulation, then return to local front panel control. Then perform the following:

PROGRAM 5
<pre> 0: wrt 719,"IPMD1";ilcl 719;stp 1: wrt 719,"OPFA";ired 719,A 2: prt "Start Freq =",A/1e6 3: wrt 719,"OPFB";ired 719,B 4: prt "Stop Freq =",B/1e6 5: wrt 719,"OPST";ired 719,T 6: prt "Sweep Time =",1000T 7: stp *17982 </pre>

PROGRAM 5 EXPLANATION

- Line 0: Set the 8350A to a predefined instrument state via instrument preset and enable the square wave modulation. Return the 8350A

1. Adjust the 8350A to a preferred instrument state using the Start Frequency, Stop Frequency, and Sweep Time controls.
2. Press **CONTINUE** on the 9825.
3. The present values of the Start Frequency, Stop Frequency, and Sweep Time are sequentially interrogated and then printed on the internal strip printer of the 9825.

EXAMPLE PROGRAM 6: A Stepped CW Sweep

Present automatic measurement systems typically make measurements at a sequence of CW test frequencies instead of analog sweeping the frequency range of interest. If swept, the measurement data taking machine would need to sample the RF signal at a very fast rate to maintain accurate frequency information, too. This is typically not accomplished. Stepped CW sweeps can be accomplished in several ways with the 8350A:

1. Program sequential CW test frequencies.
2. Program the frequency sweep range then enable the manual sweep mode. Perform a stepped manual sweep by repetitively programming the step up/increment function.
3. Program the CW frequency to the start frequency, the Step Size to an appropriate value, then repetitively program the step up/increment function.

Considering the speed of programming the above approaches, the third is the most efficient time wise. This program illustrates a stepped sweep using this approach.

PROGRAM 6	
0:	wrt 719,"IPMD1"
1:	ent "Start Freq (GHz) = ?",A
2:	ent "Stop Freq (GHz) = ?",B
3:	ent "Step Size (GHz) = ?",C
4:	(B-A)/C+D
5:	wrt 719,"CWSS",C,"GZ"
6:	wrt 719,"CW",A,"GZ"
7:	for I=1 to D
8:	wrt 719,"UP";wait 20
9:	next I;to -3
	*21490

PROGRAM 6 EXPLANATION

- Line 0: Set the 8350A to a predefined instrument state and enable the square wave modulation.
- Line 1: The 9825 displays "Start Freq (GHz) = ?", input prompts for start frequency of the sweep. Store it in the variable 'A'.
- Line 2: The 9825 displays "Stop Freq (GHz) = ?", input prompts for the stop frequency of the sweep. Store it in 'B'.

- Line 3: The 9825 displays "Step Size (GHz) = ?", input prompts for the step size of the sweep. Store it in 'C'.
- Line 4: Determine the number of frequency steps in sweep, store in 'D'.
- Line 5: Set the CW Step Size.
- Line 6: Set the CW frequency to the start frequency value.
- Line 7: Iterate the CW step 'D' times.
- Line 8: Program the Step Increment/Up function, then wait 20 msec for settling.
- Line 9: Continue step iteration, then go to line 6.

The equipment setup is the same as in the previous example. Reset the 9825, erase the 9825 memory, then type in the above program. Run the program. The 8350A will undergo an instrument preset and enable the square wave modulation. Then perform the following:

1. The 9825 will display "Start Freq (GHz) = ?". Answer this prompt by inputting the desired Start frequency (value in GHz) of the sweep, then press **CONTINUE**
2. The 9825 will display "Stop Freq (GHz) = ?". Answer this prompt with the desired Stop frequency (in GHz) of the sweep, then press **CONTINUE**
3. The 9825 will display "Step Size (GHz) = ?". Answer this prompt with the desired Step size (in GHz) of the sweep, then press **CONTINUE**
4. The 8350 CW frequency will be programmed to the Start frequency of the sweep selected. Then the CW frequency is repetitively incremented by the step size value. The sweep is then restarted after reaching the stop frequency.

To stop the program press **STOP** or **RESET**.

Part of the time involved in changing CW frequencies is updating the numeric LED display. This time can be reduced by blanking the numeric display via the Display Update On/Off function. This can be implemented by modifying line 0 to: wrt 719, "IPMD1DU0". Re-run the modified program.

EXAMPLE PROGRAM 7: Using Service Requests, Status Bytes, and Request Mask

Certain error conditions of the 8350A can be detected by the 9825 so that corrective action can be taken. Examples of some detectable error conditions are RF power unlevelled, numeric data entry out of range, and line power failure. If an error condition exists, the user can instruct the 8350A to request service from the 9825 by initiating a Service Request (SRQ). The 9825 can detect whether an SRQ has taken place on the bus by analyzing bit 7 (see note) of the Status Byte of the 98034A HP-IB Interface. Two modes are available for analyzing the 98034A Status Byte: 1) periodically read the Status Byte, or 2) enable bit 7 to interrupt the program when it is set. In either case, once it is determined that the 8350A has requested service, the specific error condition(s) can then be determined by reading and analyzing the Status Bytes of the 8350A. The 8350A has two Status Bytes, each consisting of 8 bits with each bit indicating the present status of a particular function or condition. See Table 1 for a complete description of the conditions associated

with each Status Byte bit. The user can analyze these Status Bytes for every SRQ, or more simply, instruct the 8350A to issue an SRQ only if a specific set of error conditions exists. The set of conditions is determined by a numeric value passed by the Request Mask function. This numeric value is generated by summing the decimal values of each Status Byte bit to be checked. This program demonstrates the capability of the SRQ and Status Bytes to detect an error condition.

NOTE

This assumes that the status bits are numbered 0 thru 7 with the least-significant bit being number 0. Other references may assume that the bits are numbered 1 thru 8 with the least-significant bit being number 1.

If using an 86200 Series Plug-in, the Status Bytes can provide only limited information. Table 1 indicates which Status Byte function/bits are usable.

Table 1. 8350A Status Byte Descriptions

STATUS BYTE (#1)								
BIT #	7	6	5	4	3	2	1	0
DECIMAL VALUE	128	64	32	16	8	4	2	1
FUNCTION	Front Panel SRQ REQUEST	REQUEST SERVICE (RQS)	SRQ on Syntax Error	SRQ on End of Sweep	*SRQ on RF Settled	SRQ on Change in Extended Status Byte	SRQ on Front Panel Entry Complete	SRQ on Numeric Parameter Altered to Default Value

EXTENDED STATUS BYTE (#2)								
BIT #	7	6	5	4	3	2	1	0
DECIMAL VALUE	128	64	32	16	8	4	2	1
FUNCTION	N/A	*RF Unlevelled	Power Failure	*RF Unlocked	*External Freq. Ref. Selected	*Oven Cold	*Over Modulation	Self Test Failed

*Bit/Functions not usable with 86200 Series Plug-ins and 11869A Adapter.

PROGRAM 7 †

```
0: cli 7;clr 719;wrt 719,"IPMD1"  
1: oni 7,"SRQ"  
2: eir 7,128  
3: ent "CW Freq (GHz) = ?";F  
4: wrt 719,"CW",F,"GZ"  
5: wait 100  
6: sto -3  
7: "SRQ";rds(719)+A  
8: if bit(6,A)=0;sto +4  
9: if bit(0,A)=1;prt "Value Altered"  
10: if bit(5,A)=1;prt "Syntax Error"  
11: clr 719  
12: eir 7,128;iret  
*32644
```

PROGRAM 7 EXPLANATION

- Line 0: Clear the status of the HP-IB and the 8350A. Preset the 8350A to a predefined instrument state and enable the square wave modulation.
- Line 1: Indicate that if an interrupt from the 98034A HP-IB Interface is received that program execution will branch to the interrupt service routine located at the line labelled "SRQ".
- Line 2: Enable the controller to accept an interrupt from the 98034A if bit 7 (decimal value 128) is set.
- Line 3: The 9825 displays "CW Freq (GHz) = ?", input prompts for the desired CW frequency value in GHz. Store it in the variable 'F'.
- Line 4: Set the CW frequency as determined by 'F'.
- Line 5: Wait 100 milliseconds to allow the 8350A to interrupt.

Line 6: Go to line 3.

Line 7: Location of the interrupt service routine. Read the Status Byte of the 8350A and store it in 'A'.

Line 8: Check bit 6 of the 8350A Status Byte to see if it generated the SRQ, go to line 12 if not.

Line 9: Check bit 0 of the 8350A Status Byte for a Parameter Value Altered error indication. Print on the internal strip printer "Value Altered" if one exists.

Line 10: Check bit 5 of the 8350A Status Byte for a Syntax error. Print on the internal strip printer "Syntax Error" if one exists.

Line 11: Clear the 8350A status to enable another SRQ.

Line 12: Re-specify and re-enable interrupts from bit 7 of the 98034A, return from the interrupt service routine to the main program.

The equipment setup is the same as the previous example. Reset the 9825 memory, then type in the above program. Run the program. The 8350A will undergo an instrument preset and enable the square wave modulation. The 9825 then displays "CW Freq (GHz) = ?". Answer this prompt by inputting the desired CW frequency in GHz, then press CONTINUE. Verify that the 8350A CW frequency has been properly programmed. Try several values that are out of range of the plug-in's frequency limits and verify that an error message was printed on the strip printer. The program repeats the above input prompt. To stop the program press STOP or RESET.

† NOTE

For Program 7 to function properly, change line 0 to: 0: cli7; clr 719; wrt 719, "IPMD1RM" & char (97). This change enables status bit 5 (SRQ on Syntax Error) and bit 0 (SRQ on Numeric Parameter Altered to Default Value).

HP-IB PROGRAM CODES

CODE	DESCRIPTION	CODE	DESCRIPTION
AKm	Amplitude Marker On/Off	MZ	MHz
ALmn	Alternate Sweep On/Off	M0	Marker Off
A1	Internal Leveling	M1	Marker #1
A2	External Crystal Leveling	M2	Marker #2
A3	External Power Meter Leveling	M3	Marker #3
BK	Backspace	M4	Marker #4
CAm	Amplitude Crystal Marker On/Off (83522/ 83525 Only)	M5	Marker #5
CF	Center Frequency	NT	Network Analyzer Trigger (8410B)
CI _m	Intensity Crystal Marker On/Off (83522/ 83525 Only)	OA	Output Active Parameter
CW	CW Frequency	OL	Output Learn String
C1	1 MHz Crystal Marker Frequency (83522/ 83525 Only)	OM	Output Mode String
C2	10 MHz Crystal Marker Frequency (83522/ 83525 Only)	OP	Output Interrogated Parameter
C3	50 MHz Crystal Marker Frequency (83522/ 83525 Only)	OS	Output Status Bytes
C4	External Crystal Marker Frequency (83522/ 83525 Only)	OX	Output Micro Learn String
DF	Delta F Frequency Span	PL	Power Level
DM	dBm	PS _m	Power Sweep On/Off
DN	Step Down/Decrement	RC _n	Recall Register
DP _m	Display Blanking On/Off	RF _m	RF Power On/Off
DU _m	Display Update On/Off	RM	Service Request Mask
E	Exponent Power Of 10	RS	Reset Sweep
FA	Start Frequency	SC	Seconds
FB	Stop Frequency	SH	Shift Function
FI _m	CW Filter In/Out	SL _m	Slope On/Off
GZ	GHz	SM	Manual Sweep
HZ	Hz	SS	Step Size
IL	Input Learn String	ST	Sweep Time
IP	Instrument Preset	SV _n	Save Register
IX	Input Micro Learn String	SX	External Sweep
KZ	KHz	TS	Take Sweep
MC	Marker To Center Frequency	T1	Internal Sweep Trigger
MD _m	Square Wave Amplitude Modulation On/Off	T2	Line Sweep Trigger
MO	Marker Off	T3	External Sweep Trigger
MP _m	Marker 1-2 Sweep On/Off	T4	Single Sweep
MS	Milliseconds	UP	Step Up/Increment
		VR	CW Vernier
			0-9 + - Acceptable Numeric Data

NOTES

1. Program codes of the form "XXm" use "m" to turn the function On or Off (1 or 0). For the storage register functions the "n" is 1 through 9.
2. The 8350A ignores spaces, plus signs, negative signs (except for vernier, offset, and power values), and any unexpected characters. Program codes can be upper or lower case alpha characters.

For more information, call your local HP Sales Office or nearest Regional Office: Eastern (201) 265-5000; Midwestern (312) 255-9800; Southern (404) 955-1500; Western (213) 970-7500; Canadian (416) 678-9430. Ask the operator for instrument sales. Or write Hewlett-Packard, 1501 Page Mill Road, Palo Alto, CA 94304. In Europe: Hewlett-Packard S.A., 7, rue du Bois-du-Lan, P.O. Box, CH 1217 Meyrin 2, Geneva, Switzerland. In Japan: Yokogawa-Hewlett-Packard Ltd., 29-21, Takaido-Higashi 3-chome, Suginami-ku, Tokyo 168.

Introductory Operating Guide for the HP 8350A Sweep Oscillator with the HP 9835A Desktop Computer

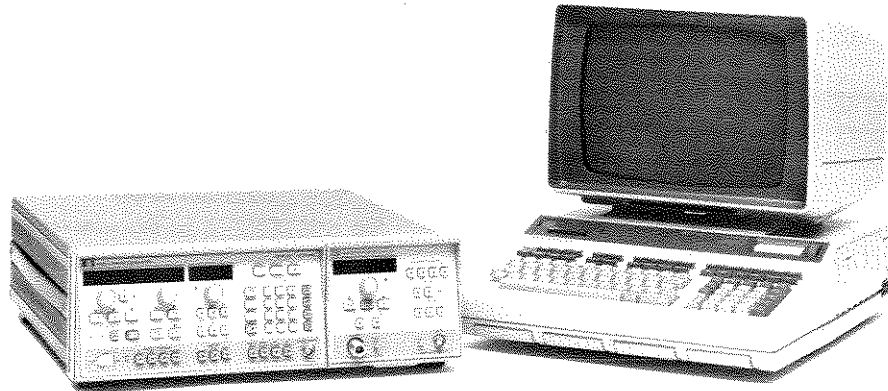

INTRODUCTION

This programming note is a guide to the remote operation of the HP 8350A Sweep Oscillator and appropriate HP 83500 Series Plug-in using the HP 9835A Desktop Computer. Included in this guide are the system connections for remote operation and several example programs with descriptions of each step.

The 8350A is fully compatible with the Hewlett-Packard Interface Bus (HP-IB). When used with a controller such as the 9835A, complete control of the sweep mode, frequency limits, frequency markers, power level, and all other front panel controls can be achieved.

REFERENCE INFORMATION

For further information on the HP Interface Bus, the following reference should prove helpful:

- Condensed Description of the Hewlett-Packard Interface Bus (HP Literature No. 59401-90030).

Complete reference information on the 8350A can be found in the 8350A Sweep Oscillator Operating and Service Manual (HP Part No. 08350-90001). For information on operating the 9835A the following references are available:

- 9835A Operating and Programming Manual (HP Part No. 09835-90000).
- 9835A I/O ROM Programming Manual (HP Part No. 09835-90060).

EQUIPMENT REQUIRED

To perform all the example programs described in this programming note, you will need the following equipment and accessories:

1. HP 8350A Sweep Oscillator with any HP 83500 Series Plug-in. Note that an HP 86200 Series Plug-in with the HP 11869A Adapter can be used but all references to power level and power control are not applicable.
2. HP 9835A Desktop Computer with:
 - a. HP 98332A I/O ROM (actually 4 ROM's)
 - b. HP 98034A Revised HP-IB Interface Card/Cable

NOTE

The following equipment is not required for the programs to function but rather for a visual display of the 8350A functions.

3. HP 8755S Frequency Response Test Set with:
 - a. HP 8755C Swept Amplitude Analyzer
 - b. HP 180TR or 182T Display Unit
 - c. HP 11664A or 11664B Detector
 - d. Two 120 cm. (4 ft.) cables (HP 11170C type).

or any appropriate Oscilloscope with Crystal/Schottky Detector, Attenuator, and BNC Cabling.

4. Any test device over the frequency range of the 83500 Series Plug-in.

SET-UP

Figure 1 shows the system connection and switch settings for the 98034A Interface and the 9835A Desktop Computer. The following procedure completes the setup:

1. Turn off the power to the 9835A.

2. Verify that the ROM's are installed in the 9835A. If not, then install the ROM's in an unused ROM drawer then insert the drawer in one of the front panel slots of the 9835A.
3. Install the 98034A Interface Card into one of the rear panel slots of the 9835A.
4. Verify that the rotary switch on top of the 98034A is set to "7". If not then set it to "7" since this is the select code for the interface card for all programs found within this guide.
5. Connect the 24-pin HP-IB connector of the 98034A to the rear panel HP-IB connector of the 8350A. This connector is tapered to insure proper connection.

CAUTION

Do not attempt to mate black metric threaded screws on one connector with silver English threaded nuts on another connector, or vice-versa, as damage may result. A metric conversion kit which will convert one cable and one or two instruments to metric hardware is available by ordering HP Part No. 5060-0138.

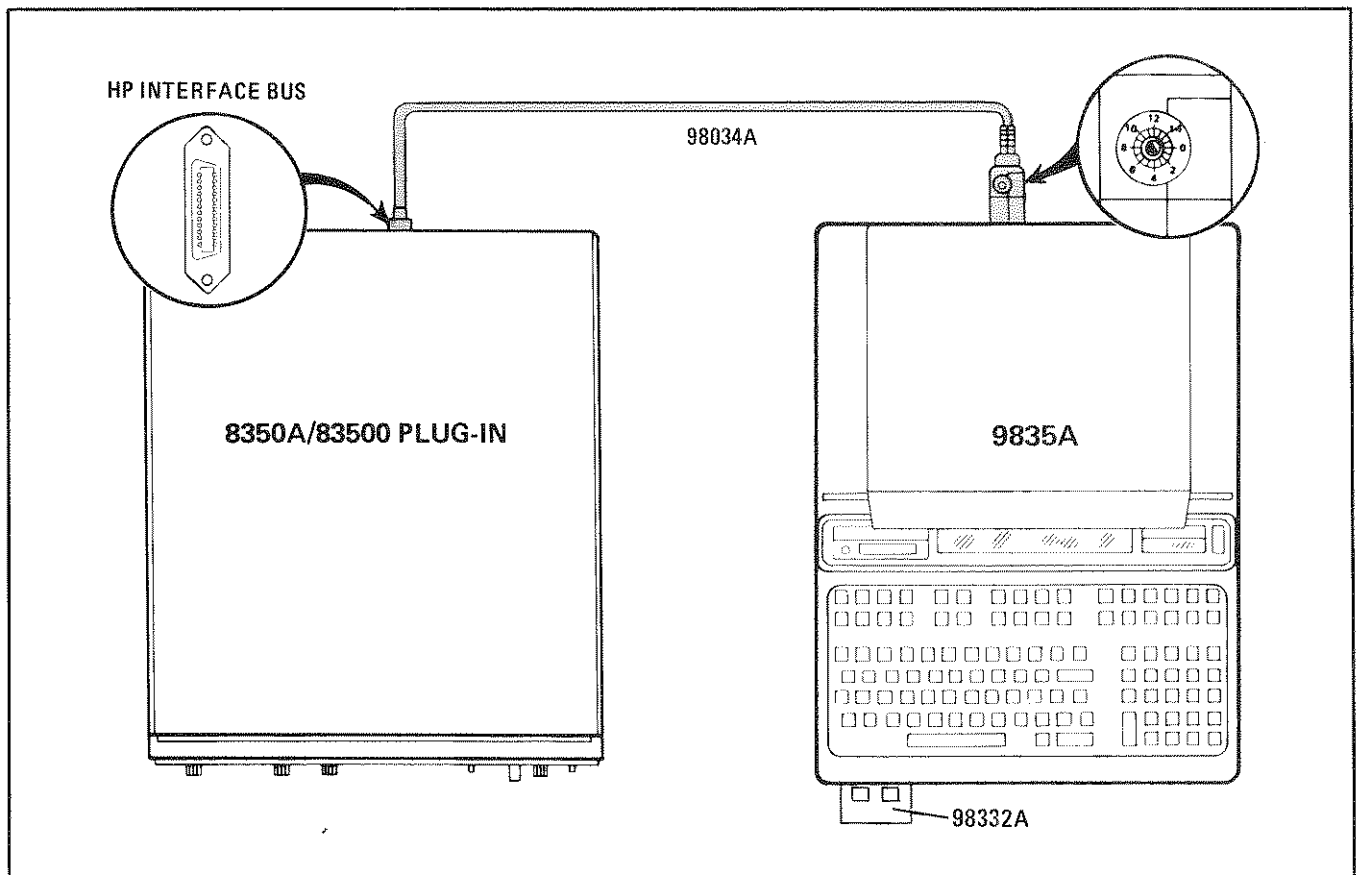

Figure 1. System Connection

6. All programs within this guide expect the 8350A HP-IB address to be decimal 19. The 8350A HP-IB address switches are located inside the instrument and are factory preset to decimal 19. To execute a front panel 'Set HP-IB Address' which will display the present HP-IB address:

Press **SHIFT** **LCL**

The FREQUENCY/TIME display will indicate the present decimal address. To reset the number if 19 is not displayed:

Press **1** **9** **GHZ**

This HP-IB address will remain in effect until the instrument is powered off since the internal address switches are read at power on (unless 8350A Option 001 Non-volatile Memory is used). Since Example 4 requires the 8350A to be powered off then on, the internal address switches should be reset to 19 if necessary.

CHECK-OUT

Turn on the 9835A and the 8350A. The 9835A should undergo an internal memory test then display "9835A READY FOR USE" on the CRT display. The 8350A should also undergo a turn-on self test consisting of the red LED numeric displays being blanked and all yellow indicator LED's on, then the 8350A sweep controls are set to the instrument preset state: Start/Stop Sweep over the entire plug-in frequency range, fastest sweep time for plug-in used (typically 10 milliseconds), and maximum leveled output power for the plug-in. If the 8350A fails the power-up self test an error message will be displayed in the far left LED display. Check section 8 of the 8350A Operating and Service Manual for error message decoding and diagnostics.

To verify that the HP-IB connections and interface are functional perform the following on the 9835A:

1. Press **CONTROL** **STOP** (or **RESET**)
2. Type 'REMOTE 719'
3. Press **EXECUTE**

EXAMPLE PROGRAM 1: Remote, Local, Local Lockout, and Instrument Preset

Before programming the 8350A for different sweep functions, the user should be aware of the extent of remote control that can be used. The Remote Enable ('REMOTE') command sets the 8350A into remote control from the local (manual) mode. In remote the 8350A will perform only as its functions are programmed. However if the LCL button is pressed, the 8350A will return from the remote state

Verify that the REM light on the 8350A is lit. If this fails, verify that the 98034A select code switch is set to "7", the 8350A address switches are set to "19", and the interface cable is properly connected.

If the 9835A display indicates an error message, it is possible that the above remote message was typed in incorrectly or the ROM's are not properly installed. If the 9835A accepts the remote statement and the display is clear but the 8350A REM light does not turn on, you could have a defective 98034A or 8350A. Perform the operational checks as outlined in the respective Operating and Service Manuals to find the defective device.

PROGRAMMING EXAMPLES

The following sample programs show the various ways of controlling the 8350A. In remote control situations the 8350A Sweep Oscillator can interact with the system HP-IB controller in two basic ways:

1. "Listen Mode": The 8350A listens to the control commands as to modifying the present instrument state. This effectively commands the 8350A to do a specific event much like setting a front panel function.
2. "Talk Mode": The 8350A informs the controller of the present instrument state with a numeric value or a string of characters. This effectively allows the user to interrogate or learn any 8350A function.

Each programming example is structured using the following format:

1. A general description of the functions exercised.
2. The program listing.
3. An explanation of each program line.
4. Detailed instructions for operating the program.

to local control. To prevent this from occurring the Local Lockout ('LOCAL LOCKOUT') command disables all front panel controls, specifically the "Local" key. The Go To Local ('LOCAL') command will return the 8350A to front panel control thereby removing it from the remote and local lockout modes. Note that the above remote and local commands are different from the general HP-IB bus

local and remote commands ('LOCAL 7' and 'REMOTE 7'). Finally, in remote control it is periodically desirable to reset the 8350A to a pre-defined state; this is achievable with the Instrument Preset function.

PROGRAM 1	
10	REMOTE 719
20	DISP "Remote"
30	PAUSE
40	REMOTE 719
50	LOCAL LOCKOUT 7
60	DISP "Local Lockout"
70	PAUSE
80	LOCAL 719
90	DISP "Local"
100	PAUSE
110	OUTPUT 719;"IP"
120	END

PROGRAM 1 EXPLANATION:

- Line 10: Sets 8350A to remote.
- Line 20: The 9835A displays "Remote".
- Line 30: Temporarily stops program execution.
- Line 40: Sets 8350A to remote.
- Line 50: Sets local lockout mode.
- Line 60: The 9835A displays "Local Lockout".
- Line 70: Temporarily stops program execution.
- Line 80: Sets 8350A to local.
- Line 90: The 9835A displays "Local".
- Line 100: Temporarily stops program execution.
- Line 110: Sets 8350A to remote and performs an Instrument Preset.
- Line 120: Stops program execution.

To verify and investigate the different remote modes do the following:

EXAMPLE PROGRAM 2: Programming Functions

To program any function on the 8350A the controller must pass specific program codes and data to the sweeper. The statement that allows this is the Output ('OUTPUT') statement. The alphanumeric data string of the output statement can be a concatenation of character strings and/or variables. The data can be specific codes, free field formatted data, or reference a specific image ('IMAGE') statement. For example, to program the CW Frequency

1. Press **CONTROL STOP, SCRATCH, A, EXECUTE** on the 9835A. This scratches the program memory.
2. Press **INSTR PRESET** on the 8350A.
3. Type in the above program.
4. Press **RUN** on the 9835A.
5. With the 9835A displaying "Remote", verify that the 8350A REM light is lit. From the front panel, verify that the start frequency cannot be changed. Verify that the INSTR PRESET key and all other keys except LCL are disabled. Now press the **LCL** key and verify that the 8350A REM light is off and that you can modify any of the sweep functions.
6. Press **CONTINUE** on the 9835A. With the 9835A displaying "Local Lockout" verify that the 8350A REM light is again lit. Again attempt to change the start frequency and perform an instrument preset. Verify that this is impossible. Now press the **LCL** key and verify that still no action is taken.
7. Press **CONTINUE** on the 9835A. With the 9835A displaying "Local" verify that the 8350A REM light is off. Also verify that all sweep functions can now be modified via the front panel controls.
8. Press **CONTINUE** on the 9835A. Verify that the 8350A has undergone an Instrument Preset and the REM light is on. The Output ('OUTPUT 719') statement does two things, one it performs a 'REMOTE 719', and second it passes data to the 8350A.

Note that the 8350A LCL key produces the same result as programming 'LOCAL 719' or 'LOCAL 7'. Be careful as the latter command places all instruments on the HP-IB in local state as opposed to the 8350A alone.

(CW), one program code sequence is "CW", the frequency in GHz, "GZ". If the frequency is to be 7.555 GHz, then the string "CW7.555GZ" will suffice. However if the frequency were to change then a variable 'F' could indicate the frequency in GHz and the program string could be "CW",F,"GZ". Using an image statement also allows a specific number of digits to be passed, thereby avoiding any unexpected round off errors.

NOTE

This program expects an 83500 Series Plug-in that covers the frequency 7.555 GHz. If using a plug-in that does not cover this frequency range then the value in lines 30 and 40 should be changed to an appropriate value.

```
PROGRAM 2
10 OUTPUT 719;"IP"
20 FIXED 2
30 OUTPUT 719;"CW7.555GZ"
40 DISP "CW = 7.555 GHz"
50 PAUSE
60 INPUT "CW (in GHz) = ?";F
70 PRINT "CW = ";F;" GHz"
80 OUTPUT 719;"CW";F;"GZ"
90 GOTO 60
100 IMAGE "CW",DD.DDD,"GZ"
110 OUTPUT 719 USING 100;F
120 GOTO 60
```

PROGRAM 2 EXPLANATION:

- Line 10: Puts the 8350A into a predefined state via instrument preset.
- Line 20: Fixes numeric data output to 2 decimal places.
- Line 30: Puts the 8350A in CW mode and programs a CW frequency of 7.555 GHz.
- Line 40: The 9835A displays "CW = 7.555 GHz".
- Line 50: Temporarily stops program execution.
- Line 60: The 9835A displays "CW (in GHz) = ?". The user is prompted to input a new CW frequency value which is stored in the variable 'F'.
- Line 70: Print on the CRT display the programmed CW frequency.
- Line 80: Program the CW frequency using the default data format.
- Line 90: Go to line 60.
- Line 100: Image statement is set up for programming the CW frequency with a 1 MHz resolution.
- Line 110: Program the CW frequency via image statement in line 100.
- Line 112: Go to line 60.

The equipment setup is the same as the previous example. Reset the 9835A, scratch the 9835A memory, then type in the above program. Then do the following:

1. Run the program. The 9835A displays "CW = 7.555 GHz". The 8350A changes from the instrument preset state of Start/Stop sweep to a CW frequency of 7.555 GHz.
2. Press **CONTINUE** on the 9835A. The 9835A now displays "CW (in GHz) = ?". Type in a new CW frequency (value in GHz), then press **CONTINUE**.
3. The 8350A will be programmed to the new CW frequency with the new value printed on the CRT display. The program jumps back to step (2) above.

When inputting the CW frequency try several values, each with a different number of digits after the decimal point. Notice that the 8350A displays the frequency to 3 decimal places (1 MHz frequency resolution). Values with better than 1 MHz frequency resolution are rounded to the nearest MHz by the 8350A. However when the 9835A is reset all numeric output data defaults to the 'FIXED 2' or fixed 2 decimal places format. Thus the 9835A rounds the desired frequency to the nearest 10 MHz. To change this free-field format to more decimal places modify the fixed format statement in line 20 to 'FIXED 5' then re-run the program. Another approach is to utilize the image statement to set the desired number of decimal places. To use the image statement in the program, do the following on the 9835A:

Press **STOP**
Type 'DEL 80, 90'
Press **EXECUTE**.

This should delete lines 80 and 90 from program #2 and allow the use of lines 100, 110, and 120 instead. Run the modified program again and use the same steps for operation as before. Now if the value inputted has a frequency resolution greater than 1 MHz the 9835A does the rounding instead of the 8350A. This is the preferred programming approach. Change the image statement for 10 MHz frequency resolution and verify the results from the 8350A frequency display.

Since a device select code address can be a variable, verify that this can be used in the modified or original program #2 by doing the following:

1. Insert before Line 10 a new line with the variable 'Swp' by:
Press **STOP**
Type '5 Swp=719'
Press **STORE**.

2. Modify the output statement(s) by editing the necessary lines and changing the 'OUTPUT 719' to 'OUTPUT Swp' and 'OUTPUT 719 USING 100' to 'OUTPUT Swp USING 100'.

3. Re-run the modified program using the same operation steps as above.

EXAMPLE PROGRAM 3: Setting Up A Typical Sweep

Typically the sweeper is programmed for the proper sweep frequency range, sweep time, power level, and marker frequencies for a test measurement. This program sets up the sweeper for a general purpose situation using several dedicated image statements. Note that not all parameters need to be reprogrammed every time.

NOTE

This program expects an 83500 Series Plug-in that covers the frequency range of at least 3 to 7 GHz. If using a plug-in with a different frequency range, change the values in lines 60, 90, and 100, to the appropriate values. If using an 86200 Series Plug-in then do not enter line 70.

PROGRAM 3	
10	IMAGE "FR", DD. DDD, "GZFB", DD. DDD, "GZ"
20	IMAGE "ST", DDDDD, "MS"
30	IMAGE "M", D, DD. DDD, "GZ"
40	IMAGE "PL", DDD. D, "DM"
50	OUTPUT 719; "IPMD1"
60	OUTPUT 719 USING 10; 3, 7
70	OUTPUT 719 USING 40; 10
80	OUTPUT 719 USING 20; 50
90	OUTPUT 719 USING 30; 1, 4
100	OUTPUT 719 USING 30; 2, 6
110	END

PROGRAM 3 EXPLANATION:

- Line 10: Image statement for setting the Start and Stop Sweep frequencies in GHz.
- Line 20: Image statement for setting the Sweep Time in milliseconds.
- Line 30: Image statement for setting a Frequency Marker by marker number and frequency in GHz.
- Line 40: Image statement for setting the Output Power Level in dBm.
- Line 50: Preset the sweeper to a known state via instrument preset and enable the internal 27.8 kHz Square Wave Amplitude Modulation.
- Line 60: Set a Start/Stop Sweep of 3.0 to 7.0 GHz.

- Line 70: Set the Output Power Level to +10 dBm.
- Line 80: Set the Sweep Time to 50 milliseconds.
- Line 90: Set Marker#1 to 4 GHz.
- Line 100: Set Marker#2 to 6 GHz.
- Line 110: Stop program execution.

Set up the equipment as shown in Figure 2 by adding the 8755C, the 180TR or 182T, the 11664, and a test device like a 4 to 6 GHz Bandpass Filter. It is important that the two rear panel connections from the 8350A to the 8755C/182T are made for a proper CRT display. For the example measurement set the following front panel controls:

On the 8755C:

Channel 1:
Display OFF (press all the display push buttons so that they are all out)

Channel 2:
Display B
dB/DIV 10 dB
Reference Level -10 dB
Reference Level Vernier OFF

On the 182T or 180TR:

Magnifier X1
Display INT

After connecting the equipment: reset the 9835A, scratch the 9835A memory, then type in the above program. Then run the program. The 8350A will initially undergo an instrument preset which will set the proper power leveling mode and sweep blanking signals. Since the 8755C requires the RF signal to be modulated at a 27.8 kHz rate, the internal amplitude modulation is enabled. If using a 4 to 6 GHz Bandpass Filter as the test device, the CRT display should reflect the filter transmission response over the 3 to 7 GHz range. Two frequency markers of the Z-Axis Intensity dot variety are set to 4 and 6 GHz, hopefully within the passband or near the 3 dB points. The setup can be modified by changing the values in lines 60, 70, 80, 90, and/or 100, then re-run the program.

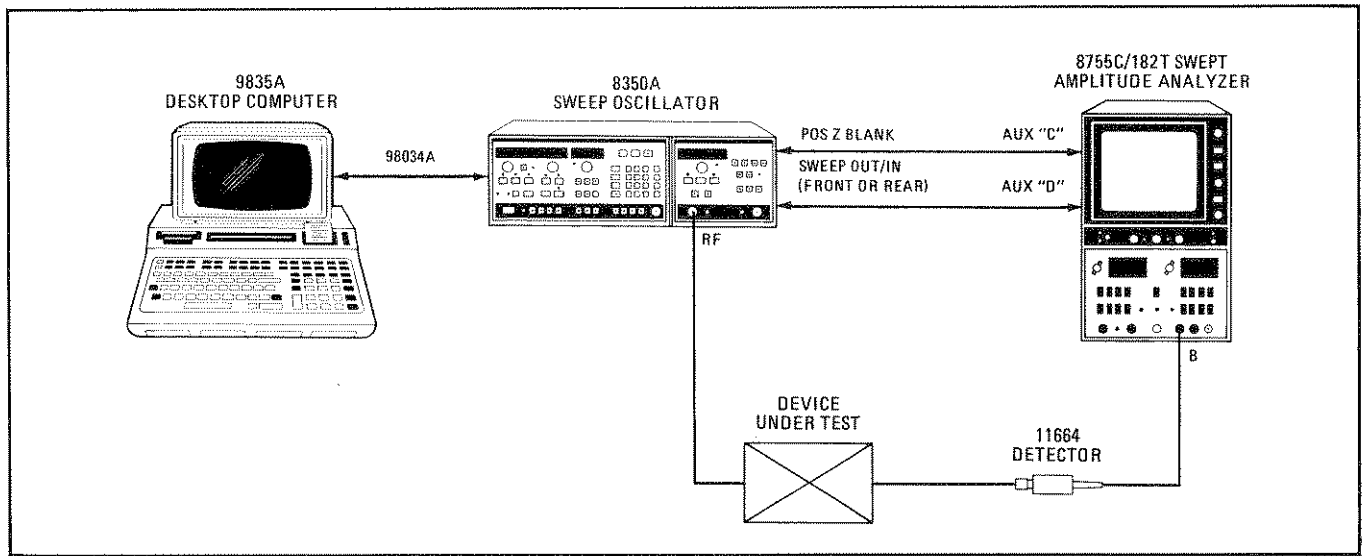

Figure 2. Equipment Setup For Program 3

EXAMPLE PROGRAM 4: Learning An Instrument State

Being able to save a specific instrument state is helpful when it is needed several times in a test or measurement procedure. The user could save the instrument state by manually logging the important sweep parameters such as frequency range, power level, ALC modes, etc., then re-inputting them at the appropriate time. A somewhat simpler approach is to save the instrument state in one of the 8350A internal storage registers, then recall it when needed. However, this is not a permanent solution unless the 8350A Non-volatile Memory option (Option 001) is used. A more permanent solution is to use the Output Learn String function of the 8350A so that the 9835A can learn then store a data string that describes the present instrument state on a tape cartridge or in its' internal memory. Once an instrument state is stored or learned, the 8350A can then be restored to that state using the Input Learn String function. The power of these instrument Learn/Teach functions are demonstrated by the following program using the 9835A fast data transfer function.

PROGRAM 4	
10	OPTION BASE 1
20	DIM A\$(100)
30	OUTPUT 719;"IPND1"
40	LOCAL 719
50	PAUSE
60	OUTPUT 719;"OL"
70	ENTER 719 BFHS 90 USING "#,90A";A\$
80	PAUSE
90	OUTPUT 719;"IL"&A\$
100	END

PROGRAM 4 EXPLANATION:

- Line 10: Define the first element in any array to be at index number 1.
- Line 20: Set the length of the A\$ string to 100 characters.
- Line 30: Set the 8350A to a predefined state via instrument preset and enable the square wave modulation.
- Line 40: Return the 8350A to local control.
- Line 50: Temporarily stops program execution.
- Line 60: Program the 8350A to output the Learn String.
- Line 70: Read the Learn String into the 9835A using a byte fast handshake transfer of 90 string characters ignoring the line feed as the string terminator. Store the 90 character Learn String in A\$.
- Line 80: Temporarily stops program execution.
- Line 90: Program the 8350A to accept a Learn String, then send the new Learn String to the 8350A.
- Line 100: Stop program execution.

Setup the equipment as in example 3 using the CRT display to verify the sweep settings. Note that the original equipment setup can also be used with the 8350A front panel indicators used for verification. Reset the 9835A, scratch the 9835A memory, then

type in the above program. Run the program. The 8350A will undergo an instrument preset, enable the square wave modulation, then return to local front panel control. Then perform the following:

1. Adjust the 8350A to a preferred instrument state, then press **CONTINUE** on the 9835A.

2. Turn the 8350A line power off. Wait five seconds then turn the 8350A power back on. Press **INSTR-PRESET** on the 8350A.
3. Press **CONTINUE** on the 9835A. Verify on the CRT display and/or the 8350A that the original instrument state has been restored.

EXAMPLE PROGRAM 5: Interrogating The Present Value Of A Function

While the 8350A Learn String enables the user to completely save a string of characters that define the present instrument state, the information is densely packed and encoded to save memory space. If the user wishes to determine the actual value of a specific parameter, say the Start Frequency, it would require a tedious process to extract a numeric value from several characters within the Learn String. An easier approach is to use the Output Interrogated Parameter function of the 8350A. With this function the 9835A instructs the 8350A to output the present numeric value of a specified function. Any function that has a numeric value associated with it can be interrogated. Note that if the parameter is not presently active, the 8350A uses a computed value or its previous value. The following program demonstrates the capability of the interrogate function.

PROGRAM 5	
10	OUTPUT 719;"IPMD1"
20	LOCAL 719
30	PAUSE
40	OUTPUT 719;"OPFR"
50	ENTER 719;R
60	PRINT "Start Freq = ";R/1E6;" MHz"
70	OUTPUT 719;"OPFB"
80	ENTER 719;B
90	PRINT "Stop Freq = ";B/1E6;" MHz"
100	OUTPUT 719;"OPST"
110	ENTER 719;T
120	PRINT "Sweep Time = ";1000*T;" msec"
130	END

PROGRAM 5 EXPLANATION:

- Line 10: Set the 8350A to a predefined instrument state via instrument preset and enable the square wave modulation.
- Line 20: Return the 8350A to local control.
- Line 30: Temporarily stops program execution.
- Line 40: Program the 8350A to output the present value of the Start Frequency.

- Line 50: Read the value into the 9835A and store it in the variable 'A'.
- Line 60: Print on the CRT display the present value of the Start Frequency in MHz.
- Line 70: Program the 8350A to output the present value of the Stop Frequency.
- Line 80: Read the value into the 9835A and store it in the variable 'B'.
- Line 90: Print on the CRT display the present value of the Stop Frequency in MHz.
- Line 100: Program the 8350A to output the present value of the Sweep Time.
- Line 110: Read the value into the 9835A and store it in the variable 'T'.
- Line 120: Print on the CRT display the present value of the Sweep Time in milliseconds.
- Line 130: Stops program execution.

Setup the equipment as in example 3 using the analyzers' CRT display to verify the sweep settings. Note that the original equipment setup can also be used with the 8350A front panel indicators used for verification. Reset the 9835A, scratch the 9835A memory, then type in the above program. Run the program. The 8350A will undergo an instrument preset, enable the square wave modulation, then return to local front panel control. Then perform the following:

1. Adjust the 8350A to a preferred instrument state using the Start Frequency, Stop Frequency, and Sweep Time controls.
2. Press **CONTINUE** on the 9835A.
3. The present values of the Start Frequency, Stop Frequency, and Sweep Time are sequentially interrogated and then printed on the CRT of the 9835A.

EXAMPLE PROGRAM 6: A Stepped CW Sweep

Present automatic measurement systems typically make measurements at a sequence of CW test frequencies instead of analog sweeping the frequency range of interest. If swept, the measurement data taking machine would need to sample the RF signal at a very fast rate to maintain accurate frequency information, too. This is typically not accomplished. Stepped CW sweeps can be accomplished in several ways with the 8350A:

1. Program sequential CW test frequencies.
2. Program the frequency sweep range then enable the manual sweep mode. Perform a stepped manual sweep by repetitively programming the step up/increment function.
3. Program the CW frequency to the start frequency, the Step Size to an appropriate value, then repetitively program the step up/increment function.

Considering the speed of programming the above approaches, the third is the most efficient. This program illustrates a stepped sweep using this approach.

PROGRAM 6	
10	OUTPUT 719;"IPMD1F10"
20	INPUT "Start Freq (GHz) = ?";A
30	INPUT "Stop Freq (GHz) = ?";B
40	INPUT "Step Size (GHz) = ?";C
50	D=(B-A)/C
60	OUTPUT 719;"CWSS";C;"GZ"
70	OUTPUT 719;"CW";A;"GZ"
80	FOR I=1 TO D
90	OUTPUT 719;"UP"
100	WAIT 20
110	NEXT I
120	GOTO 70

PROGRAM 6 EXPLANATION:

- Line 10: Set the 8350A to the predefined instrument state, enable the square wave modulation, and disable CW Filter.
- Line 20: The 9835A displays "Start Freq (GHz) = ?", input prompts for Start frequency of the sweep. Store it in the variable 'A'.
- Line 30: The 9835A displays "Stop Freq (GHz) = ?", input prompts for the stop frequency of the sweep. Store it in 'B'.
- Line 40: The 9835A displays "Step Size (GHz) = ?", input prompts for the step size of the sweep. Store it in 'C'.

- Line 50: Determine the number of frequency steps in sweep, store in 'D'.
- Line 60: Set the CW Step Size.
- Line 70: Set the CW frequency to the start frequency value.
- Line 80: Iterate the CW step 'D' times.
- Line 90: Program the Step Increment/Up function.
- Line 100: Wait 20 milliseconds for settling.
- Line 110: Continue step iteration.
- Line 120: Go to line 70.

The equipment setup is the same as in the previous example. Reset the 9835A, scratch the 9835A memory, then type in the above program. Run the program. The 8350A will undergo an instrument preset and enable the square wave modulation. Then perform the following:

1. The 9835A will display "Start Freq (GHz) = ?". Answer this prompt by inputting the desired Start frequency (value in GHz) of the sweep, then press CONTINUE.
2. The 9835A will display "Stop Freq (GHz) = ?". Answer this prompt with the desired Stop frequency (in GHz) of the sweep, then press CONTINUE.
3. The 9835A will display "Step Size (GHz) = ?". Answer this prompt with the desired Step size (in GHz) of the sweep, then press CONTINUE.
4. The 8350A CW frequency will be programmed to the Start frequency of the sweep selected. Then the CW frequency is repetitively incremented by the step size value. The sweep is then restarted after reaching the stop frequency.

To stop the program press STOP.

Since part of the time involved in changing CW frequencies is in updating the numeric LED display if this could be defeated the CW frequency time can be optimized. Note that one drawback is that the numeric display will not indicate the present frequency. The 8350A provides a Display Update On/Off function and it can be implemented by modifying line 10 to be:

```
OUTPUT 719;"IPMD1F10DU0"
```

Then re-run the modified program using the same operation steps as above.

EXAMPLE PROGRAM 7: Using Service Requests, Status Bytes, and Request Mask

Certain error conditions of the 8350A can be detected by the 9835A so that corrective action can be taken. Examples of some detectable error conditions are RF power unlevelled, numeric data entry out of range, and line power failure. If an error condition exists, the user can instruct the 8350A to request service from the 9835A by initiating a Service Request (SRQ). The 9835A can detect whether an SRQ has taken place on the bus by analyzing bit 7 (see note below) of the Status Byte of the 98034A HP-IB Interface. Two modes are available for analyzing the 98034A Status Byte: (1) periodically read the Status Byte, or (2) enable bit 7 to interrupt the program when it is set. In either case, once it is determined that the 8350A has requested service, the specific error condition(s) can then be determined by reading and analyzing the Status Bytes of the 8350A. The 8350A has two Status Bytes, each consisting of 8 bits with each bit indicating the present status of a particular function or condition. See Table 1 for a complete description of the conditions associated with each Status Byte bit. The user can analyze these Status Bytes for every SRQ, or more simply, instruct the 8350A to issue an SRQ only if a specific set of error conditions exists. The set of conditions is determined by a numeric value passed by the Request Mask function. This numeric value is generated by summing the decimal values of each Status Byte bit to be checked. This program demonstrates the capability of the SRQ and Status Bytes to detect an error condition.

```
PROGRAM 7
10  ABORTIO 7
20  CLEAR 719
30  OUTPUT 719;"IPMB1RM"&CHR#(97)
40  ON INT #7 GOSUB Srq
50  CONTROL MASK 7;128
60  CARD ENABLE 7
70  INPUT "CW Freq (GHz) = ?";F
80  OUTPUT 719;"CW";F;"GZ"
90  WAIT 100
100 GOTO 70
110 Srq: STATUS 719;A
120 IF BIT(A,6)<>1 THEN GOTO 160
130 IF BIT(A,0)=1 THEN PRINT
    "Parameter Altered"
140 IF BIT(A,5)=1 THEN PRINT "Syntax Error"
150 CLEAR 719
160 CONTROL MASK 7;128
170 CARD ENABLE 7
180 RETURN
```

NOTE

This assumes that the status bits are numbered 0 thru 7 with the least-significant bit being number 0. Other references may assume that the bits are numbered 1 thru 8 with the least-significant bit being number 1.

If using an 86200 Series Plug-in, the Status Bytes can provide only limited information. Table 1 indicates which Status Byte functions/bits are usable.

PROGRAM 7 EXPLANATION:

- Line 10: Clear the status of the HP-IB.
- Line 20: Clear the status of the 8350A.
- Line 30: Preset the 8350A to a predefined instrument state and enable the square wave modulation, and set the Request Mask to enable Parameter Altered and Syntax Error SRQ's.
- Line 40: Indicate that if an interrupt from the 98034A HP-IB Interface is received that program execution will branch to the interrupt service routine located at the line labelled 'Srq'.
- Line 50: Specify an interrupt from the 98034A if bit 7 (decimal value 128) is set.
- Line 60: Enable the controller to accept an interrupt from the 98034A.
- Line 70: The 9835A displays "CW Freq (GHz) = ?", input prompts for the desired CW frequency value in GHz. Store it in the variable 'F'.
- Line 80: Set the CW frequency as determined by 'F'.
- Line 90: Wait 100 milliseconds to allow the 8350A to interrupt.
- Line 100: Go to line 70.
- Line 110: Location of the interrupt service routine. Read the Status Byte of the 8350A and store it in 'A'.

- Line 120: Check bit 0 of the 8350A Status Byte for an Altered Parameter error. Print on the CRT display "Parameter Altered" if one exists.
- Line 130: Check bit 5 of the 8350A Status Byte for a Syntax error. Print on the CRT display "Syntax Error" if one exists.
- Line 140: Clear the 8350A Status Byte to enable another SRQ.
- Line 150: Re-specify bit 7 of the 98034A to cause an interrupt.
- Line 160: Re-enable interrupts from the 98034A.
- Line 170: Return from the interrupt service routine to the main program.

The equipment setup is the same as the previous example. Reset the 9835A, scratch the 9835A memory, then type in the above program. Run the program. The 8350A will undergo an instrument preset and enable the square wave modulation. The 9835A then displays "CW Freq (GHz) =?". Answer this prompt by inputting the desired CW frequency in GHz, then press CONTINUE. Verify that the 8350A CW frequency has been properly programmed. Try several values that are out of range of the plug-in's frequency limits and verify that an error message was printed on the CRT display. The program repeats the above input prompt. To stop the program press STOP.

Table 1. 8350A Status Byte Descriptions

STATUS BYTE (#1)								
BIT #	7	6	5	4	3	2	1	0
DECIMAL VALUE	128	64	32	16	8	4	2	1
FUNCTION	N/A	REQUEST SERVICE (RQS)	SRQ on Syntax Error	SRQ on End of Sweep	N/A	SRQ on Change in Extended Status Byte	N/A	SRQ on Numeric Parameter Altered to Default Value

EXTENDED STATUS BYTE (#2)								
BIT #	7	6	5	4	3	2	1	0
DECIMAL VALUE	128	64	32	16	8	4	2	1
FUNCTION	Airflow Failure	*RF Unleveled	Power Failure/on	N/A	N/A	N/A	N/A	Self Test Failed

*Bit/Functions not usable with 86200 Series Plug-ins and 11869A Adapter.

HP-IB PROGRAMMING CODES

Code	Description	Code	Description
AKm	Amplitude Marker On/Off	MPm	Marker 1-2 Sweep On/Off
ALmn	Alternate Sweep On/Off	M5	Milliseconds
A1	Internal Leveling	MZ	MHz
A2	External Crystal Leveling	M0	Marker Off
A3	External Power Meter Leveling	M1	Marker #1
BK	Backspace	M2	Marker #2
CAm	Amplitude Crystal Marker On/Off (83522/83525 Only)	M3	Marker #3
CF	Center Frequency	M4	Marker #4
Clm	Intensity Crystal Marker On/Off (83522/83525 Only)	M5	Marker #5
CW	CW Frequency	NT	Network Analyzer Trigger (8410B)
C1	1 MHz Crystal Marker Frequency (83522/83525 Only)	OA	Output Active Parameter
C2	10 MHz Crystal Marker Frequency (83522/83525 Only)	OL	Output Learn String
C3	50 MHz Crystal Marker Frequency (83522/83525 Only)	OM	Output Mode String
C4	External Crystal Marker Frequency (83522/83525 Only)	OP	Output Interrogated Parameter
DF	Delta F Frequency Span	OS	Output Status bytes
DM	dBm	OX	Output Micro Learn String
DN	Step Down/Decrement	PL	Power Level
Dpm	Display Blanking On/Off	PSm	Power Sweep On/Off
DUm	Display Update On/Off	RCn	Recall Register
E	Exponent Power Of 10	RFm	RF Power On/Off
FA	Start Frequency	RM	Service Request Mask
FB	Stop Frequency	RPm	RF Blanking On/Off
Flm	CW Filter In/Out	RS	Reset Sweep
F1	-20 MHz/V FM	SC	Seconds
F2	-6 MHz/V FM	SF	Frequency Step Size
GZ	GHz	SH	Shift Function
HZ	Hz	SLm	Slope On/Off
IL	Input Learn String	SM	Manual Sweep
IP	Instrument Preset	SP	Power Step Size
IX	Input Micro Learn String	SS	Step Size
KZ	KHz	ST	Sweep Time
MC	Marker To Center Frequency	SVn	Save Register
MDm	Square Wave Amplitude Modulation On/Off	SX	external Sweep
MO	Marker Off	TS	Take Sweep
		T1	Internal Sweep Trigger
		T2	Line Sweep Trigger
		T3	External Sweep Trigger
		T4	Single Sweep
		UP	Step Up/Increment
		VR	CW Vernier
		0-9 + -	Acceptable Numeric Data

NOTES

1. Program codes of the form "XXm" use "m" to turn the function On or Off (1 or 0). For the storage register functions the "n" is 1 through 9.
2. The 8350A ignores spaces, plus signs, negative signs (except when valid) and any unexpected characters. Program codes can be upper or lower case alpha characters.

For more information, call your local HP Sales Office or nearest Regional Office: **Eastern** (201) 265-5000; **Midwestern** (312) 255-9800; **Southern** (404) 955-1500; **Western** (213) 970-7500; **Canadian** (416) 678-9430. Ask the operator for instrument sales. Or write Hewlett-Packard, 1501 Page Mill Road, Palo Alto, CA 94304. In Europe: Hewlett-Packard S.A., 7, rue du Bois-du-Lan, P.O. Box, CH 1217 Meyrin 2, Geneva, Switzerland. In Japan: Yokogawa-Hewlett-Packard Ltd., 29-21, Takaido-Higashi 3-chome, Suginami-ku, Tokyo 168.

Introductory Operating Guide for the HP 8350A Sweep Oscillator with the HP 9845B Desktop Computer

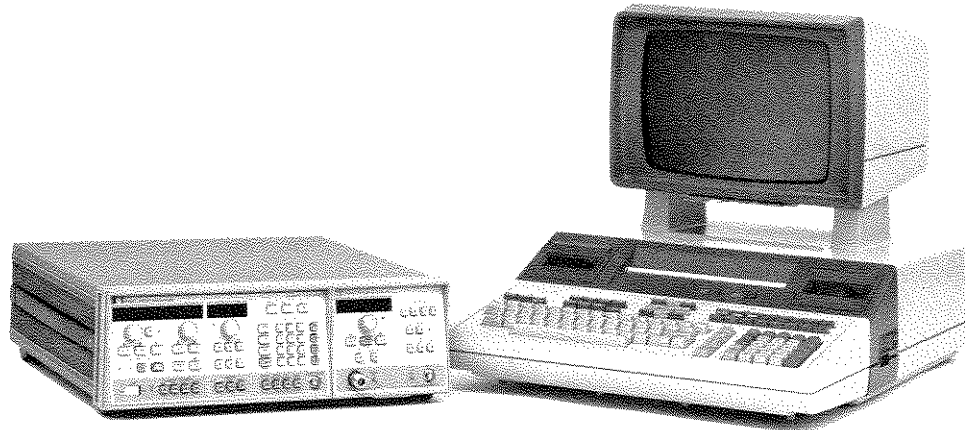

INTRODUCTION

This programming note is a guide to the remote operation of the HP 8350A Sweep Oscillator and appropriate HP 83500 Series Plug-in using the HP 9845B Desktop Computer. Included in this guide are the system connections for remote operation and several example programs with descriptions of each step.

The 8350A is fully compatible with the Hewlett-Packard Interface Bus (HP-IB). When used with a controller such as the 9845B, complete control of the sweep mode, frequency limits, frequency markers, power level, and all other front panel controls can be achieved.

REFERENCE INFORMATION

For further information on the HP Interface Bus, the following reference should prove helpful:

- Condensed Description of the Hewlett-Packard Interface Bus (HP Literature No. 59401-90030).

Complete reference information on the 8350A can be found in the 8350A Sweep Oscillator Operating and Service Manual (HP Part No. 08350-90001). For information on operating the 9845B the following references are available:

- 9845B Operating and Programming Manual (HP Part No. 09845-91000).
- 9845B I/O ROM Programming Manual (HP Part No. 09845-91060).

EQUIPMENT REQUIRED

To perform all the example programs described in this programming note, you will need the following equipment and accessories:

1. HP 8350A Sweep Oscillator with any HP 83500 Series Plug-in. Note that an HP 86200 Series Plug-in with the HP 11869A Adapter can be used but all references to power level and power control are not applicable.

2. HP 9845B Desktop Computer with:
 - a. HP 98412A I/O ROM (actually 2 ROM's)
 - b. HP 98034A Revised HP-IB Interface Card/ Cable

NOTE

The following equipment is not required for the programs to function but rather for a visual display of the 8350A functions.

3. HP 8755S Frequency Response Test Set with:
 - a. HP 8755C Swept Amplitude Analyzer
 - b. HP 180TR or 182T Display Unit
 - c. HP 11664A or 11664B Detector
 - d. Two 120 cm. (4 ft.) BNC cables (HP 11170C variety)
 or any appropriate Oscilloscope with Crystal/ Schottky Detector, Attenuator, and BNC Cabling.
4. Any test device over the frequency range of the 83500 Series Plug-in.

SET-UP

Figure 1 shows the system connection and switch settings for the 98034A Interface and the 9845B Desktop Computer. The following procedure completes the setup:

1. Turn off the power to the 9845B.
2. Verify that the ROM's are installed in the 9845B. If not, then install the ROM's in the appropriate side panel drawers of the 9845B.
3. Install the 98034A Interface Card into one of the rear panel slots of the 9845B.
4. Verify that the rotary switch on top of the 98034A is set to "7". If not then set it to "7" since this is the select code for the interface card for all programs found within this guide.
5. Connect the 24-pin HP-IB connector of the 98034A to the rear panel HP-IB connector of the 8350A. This connector is tapered to insure proper connection.

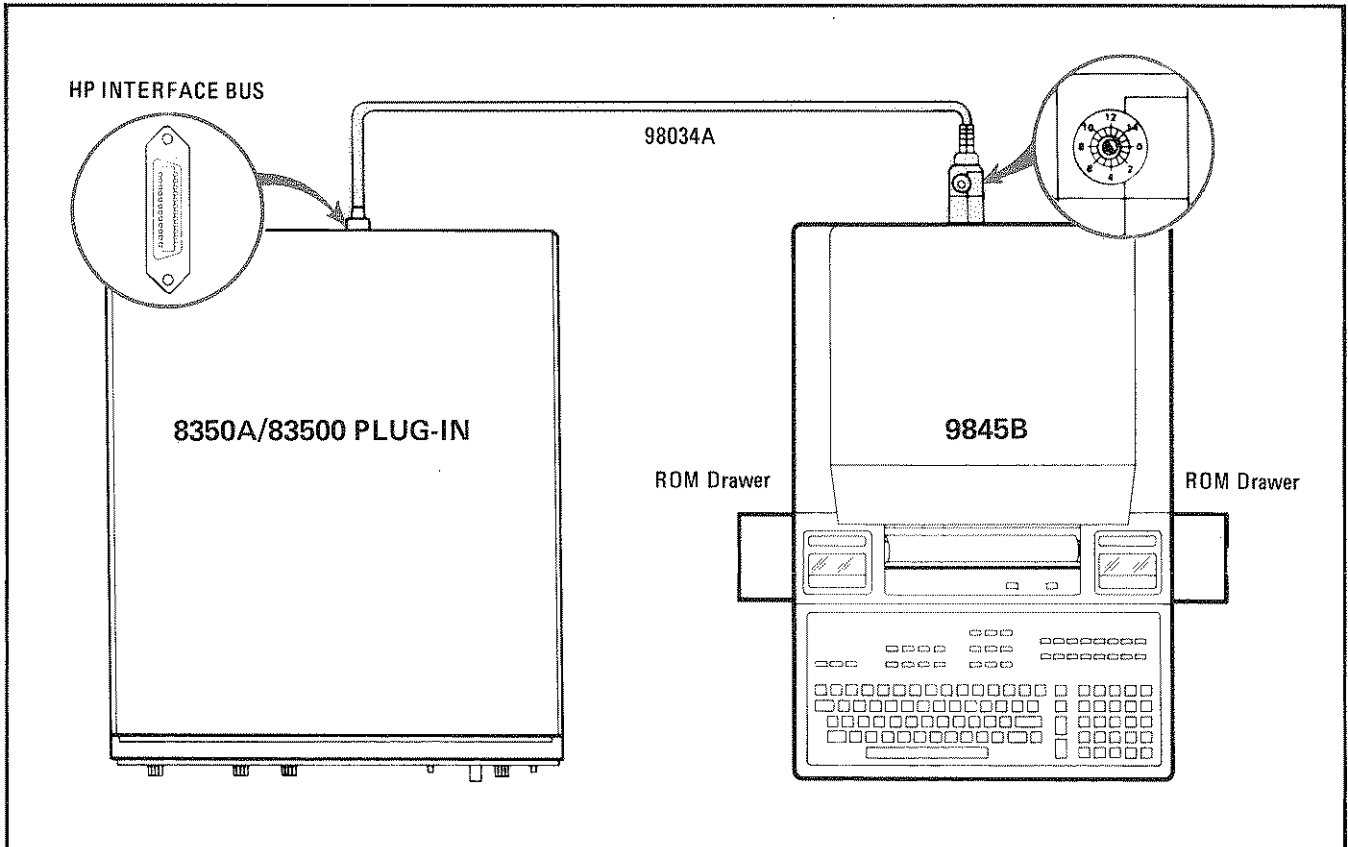

Figure 1. System Connection

CAUTION

Do not attempt to mate black metric threaded screws on one connector with silver English threaded nuts on another connector, or vice-versa, as damage may result. A metric conversion kit which will convert one cable and one or two instruments to metric hardware is available by ordering HP Part No. 5060-0138.

6. All programs within this guide expect the 8350A HP-IB address to be decimal 19. The 8350A HP-IB address switches are located inside the instrument and are factory preset to decimal 19. To execute a front panel 'Set HP-IB address' which will display the present HP-IB address:

Press **SHIFT LCL**

The FREQUENCY/TIME display will indicate the present decimal address. To reset the number if 19 is not displayed:

Press **1 9 GHz**

This HP-IB address will remain in effect until the instrument is powered off since the internal address switches are read at power on (unless 8350A Option 001 Non-volatile Memory is used). Since Example 4 requires the 8350A to be powered off then on, the internal address switches should be reset to 19 if necessary.

CHECK-OUT

Turn on the 9845B and the 8350A. The 9845B should undergo an internal memory test then display "9845B READY FOR USE" on the CRT display. The 8350A should also undergo a turn-on self test consisting of the red LED numeric displays being blanked and all yellow indicator LED's on, then the 8350A sweep controls are set to the instrument preset state: Start/Stop Sweep over the entire plug-in frequency range, fastest sweep time for plug-in (typically 10 milliseconds), and maximum leveled output power for the plug-in. If the 8350A fails the power-up self test an error message will be displayed in the far left LED display. Check section 8 of the 8350A Operating and Service Manual for error message decoding and diagnostics.

EXAMPLE PROGRAM 1: Remote, Local, Local Lockout, and Instrument Preset

Before programming the 8350A for different sweep functions, the user should be aware of the extent of

To verify that the HP-IB connections and interface are functional perform the following on the 9845B:

1. Press **CONTROL STOP** (or **RESET**)
2. Type 'REMOTE 719'
3. Press **EXECUTE**

Verify that the REM light on the 8350A is lit. If this fails, verify that the 98034A select code switch is set to "7", the 8350A address switches are set to "19", and the interface cable is properly connected.

If the 9845B display indicates an error message, it is possible that the above remote message was typed in incorrectly or the ROM's are not properly installed. If the 9845B accepts the remote statement and the display is clear but the 8350A REM light does not turn on, you could have a defective 98034A or 8350A. Perform the operational checks as outlined in the respective Operating and Service Manuals to find the defective device.

PROGRAMMING EXAMPLES

The following sample programs show the various ways of controlling the 8350A. In remote control situations the 8350A Sweep Oscillator can interact with the system HP-IB controller in two basic ways:

1. "Listen Mode": Here the 8350A listens to the control commands as to modifying the present instrument state. This effectively commands the 8350A to do a specific event much like setting a front panel function.
2. "Talk Mode": Here the 8350A informs the controller of the present instrument state with a numeric value or a string of characters. This effectively allows the user to interrogate or learn any 8350A function.

Each programming example is structured using the following format:

1. A general description of the functions exercised
2. The program listing
3. An explanation of each program line
4. Detailed instructions for operating the program.

remote control that can be used. The Remote Enable ('REMOTE') command sets the 8350A into

remote control from the local (manual) mode. In remote the 8350A will perform only as its functions are programmed. However if the LCL button is pressed, the 8350A will return from the remote state to local control. To prevent this from occurring the Local Lockout ('LOCAL LOCKOUT') command disables all front panel controls, specifically the "Local" key. The Go To Local ('LOCAL') command will return the 8350A to front panel control thereby removing it from the remote and local lockout modes. Note that the above remote and local commands are different from the general HP-IB bus local and remote commands ('LOCAL 7' and 'REMOTE 7'). Finally, in remote control it is periodically desirable to reset the 8350A to a predefined state, this is achievable with the Instrument Preset function.

PROGRAM 1	
10	REMOTE 719
20	DISP "Remote"
30	PAUSE
40	REMOTE 719
50	LOCAL LOCKOUT 7
60	DISP "Local Lockout"
70	PAUSE
80	LOCAL 719
90	DISP "Local"
100	PAUSE
110	OUTPUT 719; "IF"
120	END

PROGRAM 1 EXPLANATION:

- Line 10: Sets 8350A to remote.
- Line 20: The 9845B displays "Remote".
- Line 30: Temporarily stops program execution.
- Line 40: Sets 8350A to remote.
- Line 50: Sets local lockout mode.
- Line 60: The 9845B displays "Local Lockout".
- Line 70: Temporarily stops program execution.
- Line 80: Sets 8350A to local.
- Line 90: The 9845B displays "Local".
- Line 100: Temporarily stops program execution.
- Line 110: Sets 8350A to remote and performs an Instrument Preset.

EXAMPLE PROGRAM 2: Programming Functions

To program any function on the 8350A the controller must pass specific program codes and data to the sweeper. The statement that allows this is the Output ('OUTPUT') statement. The alphanumeric data string of the output statement can be a

Line 120: Stops program execution.

To verify and investigate the different remote modes do the following:

1. Press **CONTROL STOP SCRATCH A EXECUTE** on the 9845B. This scratches the program memory.
 2. Press **INSTR PRESET** on the 8350A.
 3. Type in the above program.
 4. Press **RUN** on the 9845B.
 5. With the 9845B displaying "Remote", verify that the 8350A REM light is lit. From the front panel, attempt to change the start frequency and verify that this is impossible. Verify that the Instrument Preset key and all other keys except LCL are disabled. Now press the LCL key and verify that the 8350A REM light is off and that you can modify any of the sweep functions.
 6. Press **CONT** on the 9845B. With the 9845B displaying "Local Lockout" verify that the 8350A REM light is again lit. Again attempt to change the start frequency and perform an instrument preset. Verify that this is impossible. Now press the LCL key and verify that still no action is taken.
 7. Press **CONT** on the 9845B. With the 9845B displaying "Local" verify that the 8350A REM light is off. Also verify that all sweep functions can now be modified via the front panel controls.
 8. Press **CONT** on the 9845B. Verify that the 8350A has undergone an Instrument Preset and the REM light is on. The Output ('OUTPUT 719') statement does two things, one it performs a 'REMOTE 719', and second it passes data to the 8350A.
- Note that the 8350A LCL key produces the same result as programming 'LOCAL 719' or 'LOCAL 7'. Be careful as the latter command places all instruments on the HP-IB in local state as opposed to the 8350A alone.

followed by the frequency in GHz, then "GZ". If the frequency is to be 7.555 GHz, then the string "CW7.555GZ" will suffice. However if the frequency were to change then a variable 'F' could indicate the frequency in GHz and the program string could be "CW",F,"GZ". Using an image statement also allows a specific number of digits to be passed, thereby avoiding any unexpected round off errors.

NOTE

This program expects an 83500 Series Plug-in that covers the frequency 7.555 GHz. If using a plug-in that does not cover this frequency range then the value in lines 30 and 40 should be changed to an appropriate value.

PROGRAM 2	
10	OUTPUT 719;"IP"
20	FIXED 2
30	OUTPUT 719;"CW7.555GZ"
40	DISP "CW = 7.555 GHz"
50	PAUSE
60	INPUT "CW (in GHz) = ?",F
70	PRINT "CW = ";F;" GHz"
80	OUTPUT 719;"CW";F;"GZ"
90	GOTO 60
100	IMAGE "CW",DD.DDD,"GZ"
110	OUTPUT 719 USING 100;F
120	GOTO 60

PROGRAM 2 EXPLANATION:

- Line 10: Puts the 8350A into a predefined state via instrument preset.
- Line 20: Fixes numeric data output to 2 decimal places.
- Line 30: Puts the 8350A in CW mode and programs a CW frequency of 7.555 GHz.
- Line 40: The 9845B displays "CW = 7.555 GHz".
- Line 50: Temporarily stops program execution.
- Line 60: The 9845B displays "CW (in GHz) = ?". The user is prompted to input a new CW frequency value which is stored in the variable 'F'.
- Line 70: Print on the CRT display the programmed CW frequency.
- Line 80: Program the CW frequency using the default data format.

Line 90: Go to line 60.

Line 100: Image statement is set up for programming the CW frequency with a 1 MHz resolution.

Line 110: Program the CW frequency via image statement in line 100.

Line 120: Go to line 60.

The equipment setup is the same as the previous example. Reset the 9845B, scratch the 9845B memory, then type in the above program. Then do the following:

1. Run the program. The 9845B displays "CW = 7.555 GHz". The 8350A changes from the instrument preset state of Start/Stop sweep to a CW frequency of 7.555 GHz.
2. Press **CONT** on the 9845B. The 9845B now displays "CW (in GHz) = ?". Type in a new CW frequency (value in GHz), then press **CONT**.
3. The 8350A will be programmed to the new CW frequency with the new value printed on the CRT display. The program jumps back to step (2) above.

When inputting the CW frequency try several values, each with a different number of digits after the decimal point. Notice that the 8350A displays the frequency to 3 decimal places (1 MHz frequency resolution). Values with better than 1 MHz frequency resolution are rounded to the nearest MHz by the 8350A. However when the 9845B is reset all numeric output data defaults to the 'FIXED 2' or fixed 2 decimal places format. Thus the 9845B rounds the desired frequency to the nearest 10 MHz. To change this free-field format to more decimal places modify the fixed format statement in line 20 to 'FIXED 5' from the keyboard then re-run the program. Another approach is to utilize the image statement to set the desired number of decimal places. To use the image statement in the program, do the following on the 9845B:

Press **STOP**
 Type 'DEL 80, 90'
 Press **EXECUTE**

This should delete lines 80 and 90 from program #2 and allow the use of lines 100, 110, and 120 instead. Run the modified program again and use the same steps for operation as before. Now if the value

inputted has a frequency resolution greater than 1 MHz the 9845B does the rounding instead of the 8350A. This is the preferred programming approach. Change the image statement for 10 MHz frequency resolution and verify the results from the 8350A frequency display.

Since a device select code address can be a variable, verify that this can be used in the modified or original program #2 by doing the following:

1. Insert before Line 10 a new line with the variable 'Swp' by:

Press STOP
Type '5 Swp=719'
Press STORE

2. Modify the output statement(s) by editing the necessary lines and changing the 'OUTPUT 719' to 'OUTPUT Swp' and 'OUTPUT 719 USING 100' to 'OUTPUT Swp USING 100'.
3. Re-run the modified program using the same operation steps as above.

EXAMPLE PROGRAM 3: Setting Up A Typical Sweep

Typically the sweeper is programmed for the proper sweep frequency range, sweep time, power level, and marker frequencies for a test measurement. This program sets up the sweeper for a general purpose situation using several dedicated image statements. Note that not all parameters need to be reprogrammed every time.

NOTE

This program expects an 83500 Series Plug-in that covers the frequency range of at least 3 to 7 GHz. If using a plug-in with a different frequency range, change the values in lines 60, 90, and 100, to the appropriate values. If using an 86200 Series Plug-in then do not enter line 70.

PROGRAM 3	
10	IMAGE "FR", DD, DDD, "GZFB", DD, DDD, "GZ"
20	IMAGE "ST", DDDDD, "MS"
30	IMAGE "M", D, DD, DDD, "GZ"
40	IMAGE "PL", DDD, D, "DM"
50	OUTPUT 719: "IPMD1"
60	OUTPUT 719 USING 10;3,7
70	OUTPUT 719 USING 40;10
80	OUTPUT 719 USING 20;50
90	OUTPUT 719 USING 30;1,4
100	OUTPUT 719 USING 30;2,6
110	END

PROGRAM 3 EXPLANATION:

- Line 10: Image statement for setting the Start and Stop Sweep frequencies in GHz.
- Line 20: Image statement for setting the Sweep Time in milliseconds.
- Line 30: Image statement for setting a Frequency Marker by marker number and frequency in GHz.

- Line 40: Image statement for setting the Output Power Level in dBm.
- Line 50: Preset the sweeper to a known state via instrument preset and enable the internal 27.8 kHz Square Wave Amplitude Modulation.
- Line 60: Set a Start/Stop Sweep of 3.0 to 7.0 GHz.
- Line 70: Set the Output Power Level to +10 dBm.
- Line 80: Set the Sweep Time to 50 milliseconds.
- Line 90: Set Marker#1 to 4 GHz.
- Line 100: Set Marker#2 to 6 GHz.
- Line 110: Stops program execution.

Set up the equipment as shown in Figure 2 by adding the 8755C, the 180TR or 182T, the 11664, and a test device like a 4 to 6 GHz Bandpass Filter. It is important that the two rear panel connections from the 8350A to the 8755C/182T are made for a proper CRT display. For the example measurement set the following front panel controls:

On the 8755C:

Channel 1:

Display OFF (press all the display push buttons so that they are all out)

Channel 2:

Display B
dB/DIV 10 dB
Reference Level -10 dB
Reference Level Vernier OFF

On the 182T or 180TR:

Magnifier X1
Display INT

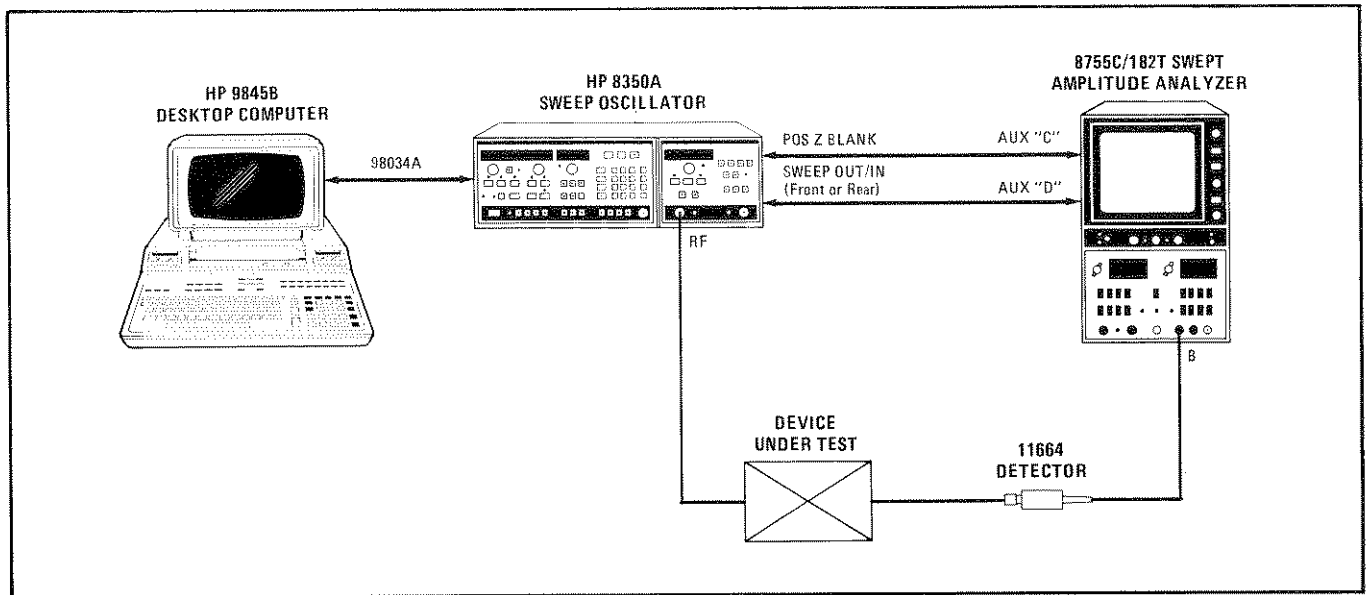

Figure 2. Equipment Setup For Program 3

After connecting the equipment: reset the 9845B, scratch the 9845B memory, then type in the above program. Then run the program. The 8350A will initially undergo an instrument preset which will set the proper power leveling mode and sweep blanking signals. Since the 8755C requires the RF signal to be modulated at a 27.8 kHz rate, the internal amplitude modulation is enabled. If using a

4 to 6 GHz Bandpass Filter as the test device, the CRT display should reflect the filter transmission response over the 3 to 7 GHz range. Two frequency markers of the Z-Axis Intensity dot variety are set to 4 and 6 GHz, hopefully within the passband or near the 3 dB points. The setup can be modified by changing the values in lines 60, 70, 80, 90, and/or 100, then re-run the program.

EXAMPLE PROGRAM 4: Learning An Instrument State

Being able to save a specific instrument state is helpful when it is needed several times in a test or measurement procedure. The user could save the instrument state by manually logging the important sweep parameters such as frequency range, power level, ALC modes, etc., then re-inputting them at the appropriate time. A somewhat simpler approach is to save the instrument state in one of the 8350A internal storage registers, then recall it when needed. However, this is not a permanent solution unless the 8350A Non-volatile Memory option (Option 001) is used. A more permanent solution is to use the Output Learn String function of the 8350A so that the 9845B can learn then store a data string that describes the present instrument state on a tape cartridge or in its' internal memory. Once an instrument state is stored or learned, the 8350A can then be restored to that state using the Input Learn String function. The power of these instrument Learn/Teach functions are demonstrated by the following program using the 9845B fast data transfer function.

```

PROGRAM 4
10  OPTION BASE 1
20  DIM A$(100)
30  OUTPUT 719;"IPMD1"
40  LOCAL 719
50  PAUSE
60  OUTPUT 719;"DL"
70  ENTER 719 BFHS 90 USING "#,90A";A$
80  PAUSE
90  OUTPUT 719;"IL"&A$
100 END

```

PROGRAM 4 EXPLANATION:

- Line 10: Define the first element in any array to be at index number 1.
- Line 20: Set the length of the A\$ string to 100 characters.
- Line 30: Set the 8350A to a predefined state via instrument preset and enable the square wave modulation.

- Line 40: Return the 8350A to local control.
- Line 50: Temporarily stops program execution.
- Line 60: Program the 8350A to output the Learn String.
- Line 70: Read the Learn String into the 9845B using a byte fast handshake transfer of 90 string characters ignoring the line feed as the string terminator. Store the 90 character Learn String in A\$.
- Line 80: Temporarily stops program execution.
- Line 90: Program the 8350A to accept a Learn String, then send the new Learn String to the 8350A.
- Line 100: Stops program execution.

Setup the equipment as in example 3 using the CRT display to verify the sweep settings. Note that the original equipment setup can also be used with the 8350A front panel indicators used for verification. Reset the 9845B, scratch the 9845B memory, then type in the above program. Run the program. The 8350A will undergo an instrument preset, enable the square wave modulation, then return to local front panel control. Then perform the following:

1. Adjust the 8350A to a preferred instrument state, then press CONT on the 9845B.
2. Turn the 8350A line power off. Wait five seconds then turn the 8350A power back on. Press INSTR PRESET on the 8350A.
3. Press CONT on the 9845B. Verify on the CRT display and/or the 8350A that the original instrument state has been restored.

EXAMPLE PROGRAM 5: Interrogating The Present Value Of A Function

While the 8350A Learn String enables the user to completely save a string of characters that define the present instrument state, the information is densely packed and encoded to save memory space. If the user wishes to determine the actual value of a specific parameter, say the Start Frequency, it would require a tedious process to extract a numeric value from several characters within the Learn String. An easier approach is to use the Output Interrogated Parameter function of the 8350A. With this function the 9845B instructs the 8350A to output the present numeric value of a specified function. Any function that has a numeric value associated with it can be interrogated. Note that if the parameter is not presently active, the 8350A uses a computed value or its previous value. The following program demonstrates the capability of the interrogate function.

PROGRAM 5 EXPLANATION:

- Line 10: Set the 8350A to a predefined instrument state via instrument preset and enable the square wave modulation.
- Line 20: Return the 8350A to local control.
- Line 30: Temporarily stops program execution.
- Line 40: Program the 8350A to output the present value of the Start Frequency.
- Line 50: Read the value into the 9845B and store it in the variable 'A'.
- Line 60: Print on the CRT display the present value of the Start Frequency in MHz.
- Line 70: Program the 8350A to output the present value of the Stop Frequency.
- Line 80: Read the value into the 9845B and store it in the variable 'B'.
- Line 90: Print on the CRT display the present value of the Stop Frequency in MHz.
- Line 100: Program the 8350A to output the present value of the Sweep Time.
- Line 110: Read the value into the 9845B and store it in the variable 'T'.
- Line 120: Print on the CRT display the present value of the Sweep Time in milliseconds.
- Line 130: Stops program execution.

```

PROGRAM 5
10  OUTPUT 719;"IPMD1"
20  LOCAL 719
30  PRUSE
40  OUTPUT 719;"OPFA"
50  ENTER 719;A
60  PRINT "Start Freq = ";A/1E6;" MHz"
70  OUTPUT 719;"OPFB"
80  ENTER 719;B
90  PRINT "Stop Freq = ";B/1E6;" MHz"
100 OUTPUT 719;"OPST"
110 ENTER 719;T
120 PRINT "Sweep Time = ";1000*T;" msec"
130 END

```

Setup the equipment as in example 3 using the analyzers' CRT display to verify the sweep settings. Note that the original equipment setup can also be used with the 8350A front panel indicators used for verification. Reset the 9845B, scratch the 9845B memory, then type in the above program. Run the program. The 8350A will undergo an instrument preset, enable the square wave modulation, then return to local front panel control. Then perform the following:

1. Adjust the 8350A to a preferred instrument state using the Start Frequency, Stop Frequency, and Sweep Time controls.
2. Press **CONT** on the 9845B.
3. The present values of the Start Frequency, Stop Frequency, and Sweep Time are sequentially interrogated and then printed on the CRT of the 9845B.

EXAMPLE PROGRAM 6: A Stepped CW Sweep

Present automatic measurement systems typically make measurements at a sequence of CW test frequencies instead of analog sweeping the frequency range of interest. If swept, the measurement data taking machine would need to sample the RF signal at a very fast rate to maintain accurate frequency information, too. This is typically not accomplished. Stepped CW sweeps can be accomplished in several ways with the 8350A:

1. Program sequential CW test frequencies.
2. Program the frequency sweep range then enable the manual sweep mode. Perform a stepped manual sweep by repetitively programming the step up/increment function.
3. Program the CW frequency to the start frequency, the Step Size to an appropriate value, then repetitively program the step up/increment function.

Considering the speed of programming the above approaches, the third is the most efficient time wise. This program illustrates a stepped sweep using this approach.

PROGRAM 6	
10	OUTPUT 719;"IFMD1F10"
20	INPUT "Start Freq (GHz) = ?";A
30	INPUT "Stop Freq (GHz) = ?";B
40	INPUT "Step Size (GHz) = ?";C
50	D=(B-A)/C
60	OUTPUT 719;"CWSS";C;"GZ"
70	OUTPUT 719;"CW";A;"GZ"
80	FOR I=1 TO D
90	OUTPUT 719;"UP"
100	WRITE 20
110	NEXT I
120	GOTO 70

PROGRAM 6 EXPLANATION:

Line 10: Set the 8350A to a predefined instrument state, enable the square wave modulation, and disable CW Filter.

- Line 20: The 9845B displays "Start Freq (GHz) = ?", input prompts for Start frequency of the sweep. Store it in the variable 'A'.
- Line 30: The 9845B displays "Stop Freq (GHz) = ?", input prompts for the stop frequency of the sweep. Store it in 'B'.
- Line 40: The 9845B displays "Step Size (GHz) = ?", input prompts for the step size of the sweep. Store it in 'C'.
- Line 50: Determine the number of frequency steps in sweep, store in 'D'.
- Line 60: Set the CW Step Size.
- Line 70: Set the CW frequency to the start frequency value.
- Line 80: Iterate the CW step 'D' times.
- Line 90: Program the Step Increment/Up function.
- Line 100: Wait 20 milliseconds for settling.
- Line 110: Continue step iteration.
- Line 120: Go to line 70.

The equipment setup is the same as in the previous example. Reset the 9845B, scratch the 9845B memory, then type in the above program. Run the program. The 8350A will undergo an instrument preset and enable the square wave modulation. Then perform the following:

1. The 9845B will display "Start Freq (GHz) = ?". Answer this prompt by inputting the desired Start frequency (value in GHz) of the sweep, then press **CONT**.
2. The 9845B will display "Stop Freq (GHz) = ?". Answer this prompt with the desired Stop frequency (in GHz) of the sweep, then press **CONT**.

3. The 9845B will display "Step Size (GHz) = ?". Answer this prompt with the desired Step size (in GHz) of the sweep, then press CONT.
4. The 8350A CW frequency will be programmed to the Start frequency of the sweep selected. Then the CW frequency is repetitively incremented by the step size value. The sweep is then restarted after reaching the stop frequency.

To stop the program press STOP.

Since part of the time involved in changing CW

frequencies is in updating the numeric LED display if this could be defeated the CW frequency time can be optimized. Note that one drawback is that the numeric display will not indicate the present frequency. The 8350A provides a Display Update On/Off function and it can be implemented by modifying line 10 to be:

```
OUTPUT 719;"IPMD1FI0DU0"
```

Then re-run the modified program using the same operation steps as above.

EXAMPLE PROGRAM 7: Using Service Requests, Status Bytes, and Request Mask

Certain error conditions of the 8350A can be detected by the 9845B so that corrective action can be taken. Examples of some detectable error conditions are RF power unlevelled, numeric data entry out of range, and line power failure. If an error condition exists, the user can instruct the 8350A to request service from the 9845B by initiating a Service Request (SRQ). The 9845B can detect whether an SRQ has taken place on the bus by analyzing bit 7 (see note below) of the Status Byte of the 98034A HP-IB Interface. Two modes are available for analyzing the 98034A Status Byte: (1) periodically read the Status Byte, or (2) enable bit 7 to interrupt the program when it is set. In either case, once it is determined that the 8350A has requested service, the specific error condition(s) can then be determined by reading and analyzing the Status Bytes of the 8350A. The 8350A has two Status Bytes, each consisting of 8 bits with each bit indicating the present status of a particular function or condition. See Table 1 for a complete description of the conditions associated with each Status Byte bit. The user can analyze these Status Bytes for every SRQ, or more simply, instruct the 8350A to issue an SRQ only if a specific set of error conditions exists. The set of conditions is determined by a numeric value passed by the Request Mask function. This numeric value is generated by summing the decimal values of each Status Byte bit to be checked. This program demonstrates the capability of the SRQ and Status Bytes to detect an error condition.

NOTE

This assumes that the status bits are numbered 0 thru 7 with the least-significant bit being number 0. Other references may assume that the bits are numbered 1 thru 8 with the least-significant bit being number 1.

If using an 86200 Series Plug-in, the Status Bytes can provide only limited information. Table 1 indicates which Status Byte functions/bits are usable.

PROGRAM 7	
10	ABORTIO 7
20	CLEAR 719
30	OUTPUT 719;"IPMD1RM"&CHR\$(97)
40	ON INT #7 GOSUB Srq
50	CONTROL MASK 7;128
60	CARD ENABLE 7
70	INPUT "CW Freq (GHz) = ?";F
80	OUTPUT 719;"CW";F;"GZ"
90	WAIT 100
100	GOTO 70
110	Srq: STATUS 719;A
120	IF BIT(A,6)<>1 THEN GOTO 160
130	IF BIT(A,0)=1 THEN PRINT
	"Parameter Altered"
140	IF BIT(A,5)=1 THEN PRINT "Syntax Error"
150	CLEAR 719
160	CONTROL MASK 7;128
170	CARD ENABLE 7
180	RETURN

PROGRAM 7 EXPLANATION:

- Line 10: Clear the status of the HP-IB.
- Line 20: Clear the status of the 8350A.
- Line 30: Preset the 8350A to a predefined instrument state enable the square wave modulation, and set the Request Mask to enable Parameter Altered and Syntax Error SRQ's.
- Line 40: Indicate that if an interrupt from the 98034A HP-IB Interface is received that program execution will branch to the interrupt service routine located at the line labelled 'Srq'.
- Line 50: Specify an interrupt from the 98034A if bit 7 (decimal value 128) is set.

Table 1. 8350A Status Byte Descriptions

STATUS BYTE (#1)								
BIT #	7	6	5	4	3	2	1	0
DECIMAL VALUE	128	64	32	16	8	4	2	1
FUNCTION	N/A	REQUEST SERVICE (RQS)	SRQ on Syntax Error	SRQ on End of Sweep	N/A	SRQ on Change in Extended Status Byte	N/A	SRQ on Numeric Parameter Altered to Default Value

EXTENDED STATUS BYTE (#2)								
BIT #	7	6	5	4	3	2	1	0
DECIMAL VALUE	128	64	32	16	8	4	2	1
FUNCTION	Airflow Failure	*RF Unleveled	Power Failure/on	N/A	N/A	N/A	N/A	Self Test Failed

*Bit/Functions not usable with 86200 Series Plug-ins and 11869A Adapter.

- Line 60: Enable the controller to accept an interrupt from the 98034A.
- Line 70: The 9845B displays "CW Freq (GHz) = ?", input prompts for the desired CW frequency value in GHz. Store it in the variable 'F'.
- Line 80: Set the CW frequency as determined by 'F'.
- Line 90: Wait 100 milliseconds to allow the 8350A to interrupt.
- Line 100: Go to line 70.
- Line 110: Location of the interrupt service routine. Read the Status Byte of the 8350A and store it in 'A'.
- Line 120: Check bit 6 of the 8350A Status Byte to see if it generated the SRQ, go to line 160 if not.
- Line 130: Check bit 0 of the 8350A Status Byte for an Altered Parameter error. Print on the CRT display "Parameter Altered" if one exists.

- Line 140: Check bit 5 of the 8350A Status Byte for a Syntax error. Print on the CRT display "Syntax Error" if one exists.
- Line 150: Clear the 8350A Status Byte to enable another SRQ.
- Line 160: Re-specify bit 7 of the 98034A to cause an interrupt.
- Line 170: Re-enable interrupts from the 98034A.
- Line 180: Return from the interrupt service routine to the main program.

The equipment setup is the same as the previous example. Reset the 9845B, scratch the 9845B memory, then type in the above program. Run the program. The 8350A will undergo an instrument preset and enable the square wave modulation. The 9845B then displays "CW Freq (GHz) = ?". Answer this prompt by inputting the desired CW frequency in GHz, then press CONT. Verify that the 8350A CW frequency has been properly programmed. Try several values that are out of range of the plug-in's frequency limits and verify that an error message was printed on the CRT display. The program repeats the above input prompt. To stop the program press STOP.

HP-IB PROGRAM CODES

Code	Description	Code	Description
AKm	Amplitude Marker On/Off	MPm	Marker 1-2 Sweep On/Off
ALmn	Alternate Sweep On/Off	MS	Milliseconds
A1	Internal Leveling	MZ	MHz
A2	External Crystal Leveling	M0	Marker Off
A3	External Power Meter Leveling	M1	Marker #1
BK	Backspace	M2	Marker #2
CAm	Amplitude Crystal Marker On/Off (83522/83525 Only)	M3	Marker #3
CF	Center Frequency	M4	Marker #4
Clm	Intensity Crystal Marker On/Off (83522/83525 Only)	M5	Marker #5
CW	CW Frequency	NT	Network Analyzer Trigger (8410B)
C1	1 MHz Crystal Marker Frequency (83522/83525 Only)	OA	Output Active Parameter
C2	10 MHz Crystal Marker Frequency (83522/83525 Only)	OL	Output Learn String
C3	50 MHz Crystal Marker Frequency (83522/83525 Only)	OM	Output Mode String
C4	External Crystal Marker Frequency (83522/83525 Only)	OP	Output Interrogated Parameter
DF	Delta F Frequency Span	OS	Output Status Bytes
DM	dBm	OX	Output Micro Learn String
DN	Step Down/Decrement	PL	Power Level
DPm	Display Blanking On/Off	PSm	Power Sweep On/Off
DUm	Display Update On/Off	RCn	Recall Register
E	Exponent Power Of 10	RFm	RF Power On/Off
FA	Start Frequency	RM	Service Request Mask
FB	Stop Frequency	RPm	RF Blanking On/Off
FIm	CW Filter In/Out	RS	Reset Sweep
F1	-20 MHz/V FM	SC	Seconds
F2	-6 MHz/V FM	SF	Frequency Step Size
GZ	GHz	SH	Shift Function
HZ	Hz	SIm	Slope On/Off
IL	Input Learn String	SM	Manual Sweep
IP	Instrument Preset	SP	Power Step Size
IX	Input Micro Learn String	SS	Step Size
KZ	KHz	ST	Sweep Time
MC	Marker To Center Frequency	SVn	Save Register
MDm	Square Wave Amplitude Modulation On/Off	SX	external Sweep
MO	Marker Off	TS	Take Sweep
		T1	Internal Sweep Trigger
		T2	Line Sweep Trigger
		T3	External Sweep Trigger
		T4	Single Sweep
		UP	Step Up/Increment
		VR	CW Vernier
		0-9 + -	Acceptable Numeric Data

NOTES

1. Program codes of the form "XXm" use "m" to turn the function On or Off (1 or 0). For the storage register functions the "n" is 1 through 9.
2. The 8350A ignores spaces, plus signs, negative signs (except when valid) and any unexpected characters. Program codes can be upper or lower case alpha characters.

For more information, call your local HP Sales Office or nearest Regional Office: **Eastern** (201) 265-5000; **Midwestern** (312) 255-9800; **Southern** (404) 955-1500; **Western** (213) 970-7500; **Canadian** (416) 678-9430. Ask the operator for instrument sales. Or write Hewlett-Packard, 1501 Page Mill Road, Palo Alto, CA 94304. In Europe: Hewlett-Packard S.A., 7, rue du Bois-du-Lan, P.O. Box, CH 1217 Meyrin 2, Geneva, Switzerland. In Japan: Yokogawa-Hewlett-Packard Ltd., 29-21, Takaido-Higashi 3-chome, Suginami-ku, Tokyo 168.



Programming Note

8350A/85-1

Supersedes: None

Introductory Operating Guide for the HP 8350A Sweep Oscillator with the HP 85A Personal Computer

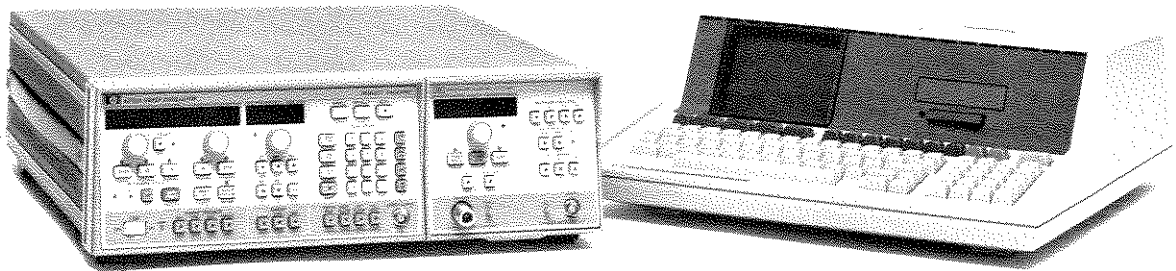

INTRODUCTION

This programming note is a guide to the remote operation of the HP 8350A Sweep Oscillator and appropriate HP 83500 Series Plug-in using the HP 85A Personal Computer. Included in this guide are the system connections for remote operation and several example programs with descriptions of each step.

The 8350A is fully compatible with the Hewlett-Packard Interface Bus (HP-IB). When used with a controller such as the 85A, complete control of the sweep mode, frequency limits, frequency markers, power level, and all other front panel controls can be achieved.

REFERENCE INFORMATION

For further information on the HP Interface Bus, the

following references should prove helpful:

- Condensed Description of the Hewlett-Packard Interface Bus (HP Literature No. 59401-90030).

Complete reference information on the 8350A can be found in the 8350A Sweep Oscillator Operating and Service Manual (HP Part No. 08350-90001). For information on operating the 85A the following references are available:

- 85A Owner's Manual and Programming Guide (HP Part No. 00085-90002).
- 85A I/O Programming Guide (HP Part No. 00085-90142).



EQUIPMENT REQUIRED

To perform all the example programs as described in this programming note, you will need the following equipment and accessories:

1. HP 8350A Sweep Oscillator with any HP 83500 Series Plug-in. Note that an HP 86200 Series Plug-in with the HP 11869A Adapter can be used but all references to power level and power control are not applicable.
2. HP 85A Personal Computer with:
 - a. HP Part No. 00085-15003 I/O ROM
 - b. HP 82936A ROM Drawer
 - c. HP 82937A HP-IB Interface Card/Cable

NOTE

The following equipment is not required for the programs to function but rather for a visual display of the 8350A functions.

3. HP 8755S Frequency Response Test Set with:
 - a. HP 8755C Swept Amplitude Analyzer
 - b. HP 180TR or 182T Display Unit
 - c. HP 11664A or 11664B Detector
 - d. Two 120 centimetre BNC cables (HP 11170C variety)or any appropriate Oscilloscope with Crystal/Schottky Detector, Attenuator, and BNC Cabling.
4. Any test device over the frequency range of the 83500 Series Plug-in.

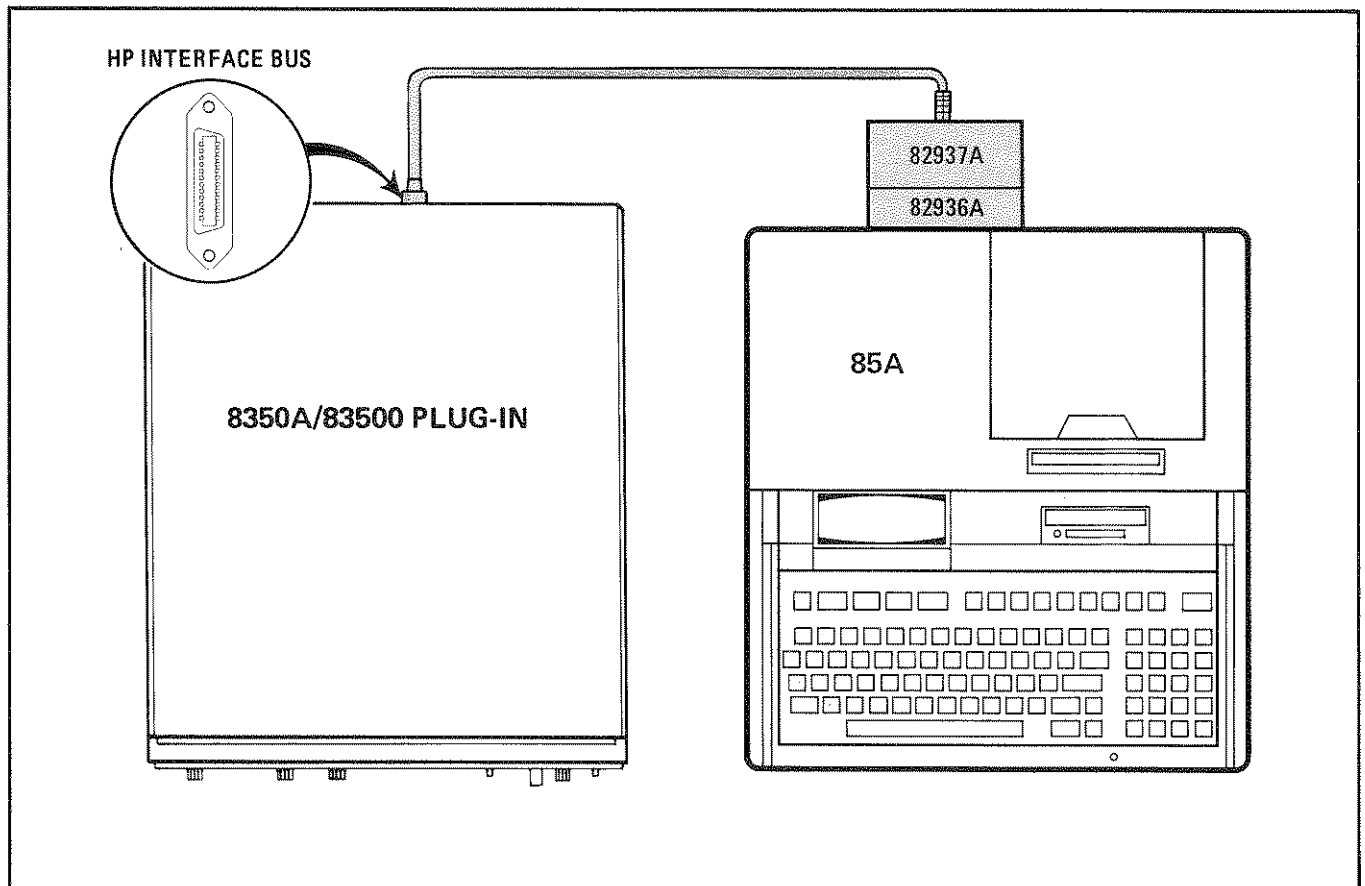

FIGURE 1: System Connection

SET-UP

Figure 1 shows the system connection and switch settings for the 82937A HP-IB Interface and the 85A Personal Computer. The following procedure completes the setup:

1. Turn off the power to the 85A.
2. Verify that the ROM is installed in the 85A. If not, then install the ROM in the 82936A ROM Drawer then insert the drawer in one of the rear panel slots of the 85A.
3. Install the 82937A HP-IB Interface Card into one of the rear panel slots of the 85A.
4. Connect the 24-pin HP-IB connector of the 82937A to the rear panel HP-IB connector of the 8350A. This connector is tapered to insure proper connection.

CAUTION

Do not attempt to mate black metric threaded screws on one connector with silver English threaded nuts on another connector, or vice-versa, as damage may result. A metric conversion kit which will convert one cable and one or two instruments to metric hardware is available by ordering HP Part No. 5060-0138.

5. All programs within this guide expect the 8350A HP-IB address to be decimal 19. The 8350A HP-IB address switches are located inside the instrument and are factory preset to decimal 19. To find the present HP-IB address use the front panel "Set HP-IB Address" by executing:

Press **SHIFT LCL**

The FREQUENCY/TIME display will indicate the present decimal address. To reset the number displayed if not 19:

Press **F 9 GHz**

This HP-IB address will remain in effect until the instrument is powered off since the internal address switches are read at power on (unless 8350A Option 001 Non-volatile Memory is used). Since Example 4 requires the 8350A to be powered off and then on, the internal address switches should be reset to 19 if necessary.

CHECK-OUT

Turn on the 85A and the 8350A. The 85A should display the cursor ("—") in the upper left corner of

the CRT display. The 8350A should undergo a turn-on self test consisting of the red LED numeric displays being blanked and all yellow indicator LED's on, then the 8350A sweep controls are set to the instrument preset state: Start/Stop Sweep over the entire plug-in frequency range, fastest sweep time for plug-in (typically 10 milliseconds), and maximum leveled output power for the plug-in. If the 8350A fails the power-on self test an error message will be displayed in the far left LED display. Check section 8 of the 8350A Operating and Service Manual for error message decoding and diagnostics.

To verify that the HP-IB connections and interface are functional perform the following on the 85A:

1. Press **SHIFT RESET**
2. Type 'REMOTE 719'
3. Press **END LINE**

Verify that the REMote light on the 8350A is lit. If this fails, verify that the 82937A select code switch is set to "7" (this switch is located inside the 82937A so refer to its Installation Manual), the 8350A address switches are set to "19", and the interface cable is properly connected.

If the 85A display indicates an error message, it is possible that the above remote message was typed in incorrectly or the ROM's are not properly installed. If the 85A accepts the remote statement and the display is clear but the 8350A REMote light does not turn on, you could have a defective 82937A or 8350A. Perform the operational checks as outlined in the respective Operating and Service Manuals to find the defective device.

PROGRAMMING EXAMPLES

The following sample programs show the various ways of controlling the 8350A. In remote control situations the 8350A Sweep Oscillator can interact with the system HP-IB controller in two basic ways:

1. "Listen Mode": The 8350A listens to the control commands as to modifying the present instrument state. This effectively commands the 8350A to do a specific event much like setting a front panel function.
2. "Talk Mode": The 8350A informs the controller of the present instrument state with a numeric value or a string of characters. This effectively allows the user to interrogate or learn any 8350A function.

Each programming example is structured using the following format:

1. A general description of the functions exercised.

2. The program listing.

3. An explanation of each program line.

4. Detailed instructions for operating the system.

EXAMPLE PROGRAM 1: Remote, Local, Local Lockout, and Instrument Preset

Before programming the 8350A for different sweep functions, the user should be aware of the extent of remote control that can be used. The Remote Enable ('REMOTE') command sets the 8350A into remote control from the local (manual) mode. In remote the 8350A will perform only as its functions are programmed. However if the LOCAL button is pressed, the 8350A will return from the remote state to local control. To prevent this from occurring the Local Lockout ('LOCAL LOCKOUT') command disables all front panel controls, specifically the "Local" key. The Go To Local ('LOCAL') command will return the 8350A to front panel control thereby removing it from the remote and local lockout modes. Note that the above remote and local commands are different from the general HP-IB bus local and remote commands ('LOCAL 7' and 'REMOTE 7'). Finally, in remote control it is periodically desirable to reset the 8350A to a pre-defined state, this is achievable with the Instrument Preset function.

```
PROGRAM 1
10 REMOTE 719
20 DISP "Remote"
30 PAUSE
40 REMOTE 719
50 LOCAL LOCKOUT 7
60 DISP "Local Lockout"
70 PAUSE
80 LOCAL 719
90 DISP "Local"
100 PAUSE
110 OUTPUT 719 ; "IP"
120 END
```

PROGRAM 1 EXPLANATION:

- Line 10: Sets 8350A to remote.
Line 20: The 85A displays "Remote".
Line 30: Temporarily stops program execution.
Line 40: Sets 8350A to remote.
Line 50: Sets local lockout mode.
Line 60: The 85A displays "Local Lockout".
Line 70: Temporarily stops program execution.
Line 80: Sets 8350A to local.
Line 90: The 85A displays "Local".
Line 100: Temporarily stops program execution.
Line 110: Sets 8350A to remote and performs an Instrument Preset.
Line 120: Stops program execution.

To verify and investigate the different remote modes do the following:

1. Press **CONTROL RESET SCRATCH END LINE** on the 85A. This scratches the program memory.
2. Press **INSTR PRESET** on the 8350A.
3. Type in the above program.
4. Press **SHIFT CLEAR RUN** on the 85A.
5. With the 85A displaying "Remote", verify that the 8350A REMote light is lit. From the front panel, attempt to change the start frequency and verify that this is impossible. Verify that the Instrument Preset key and all other keys except LCL are disabled. Now press the **LCL** key and verify that the 8350A REMote light is off and that you can modify any of the sweep functions.
6. Press **CONT** on the 85A. With the 85A displaying "Local Lockout" verify that the 8350A REMote light is again lit. Again attempt to change the start frequency and perform an instrument preset. Verify that this is impossible. Now press the 8350A **LCL** key and verify that still no action is taken.
7. Press **CONT** on the 85A. With the 85A displaying "Local" verify that the 8350A REMote light is off. Also verify that all sweep functions now can be modified via the front panel controls.
8. Press **CONT** on the 85A. Verify that the 8350A has undergone an Instrument Preset and the REMote light is on. The Output ('OUTPUT 719') statement does two things, one it performs a 'REMOTE 719', and second it passes data to the 8350A.

Note that the 8350A LCL key produces the same result as programming 'LOCAL 719' or 'LOCAL 7'. Be careful as the latter command places all instruments on the HP-IB in local state as opposed to the 8350A alone.

EXAMPLE PROGRAM 2: Programming Functions

To program any function on the 8350A the controller must pass specific program codes and data to the sweeper. The statement that allows this is the Output ('OUTPUT') statement. The alphanumeric data string of the output statement can be a concatenation of character strings and/or variables. The data can be specific codes, free field formatted data, or reference a specific image ('IMAGE') statement. For example, to program the CW Frequency (CW), one program code sequence is "CW", followed by the frequency in GHz, then "GZ". If the frequency is to be 7.555 GHz, then the string "CW7.555GZ" will suffice. However if the frequency were to change then a variable 'F' could indicate the frequency in GHz and the program string could be "CW",F,"GZ". Using an image statement also allows a specific number of digits to be passed, thereby avoiding any unexpected round off errors.

NOTE

This program expects an 83500 Series Plug-in that covers the frequency 7.555 GHz. If using a plug-in that does not cover this frequency then the value in lines 20 and 30 should be changed to an appropriate value.

```
PROGRAM 2
10 OUTPUT 719 ; "IP"
20 OUTPUT 719 ; "CW7.555GZ"
30 DISP "CW=7.555 GHz"
40 PAUSE
50 DISP "CW=(in GHz)= ";
60 INPUT F
70 PRINT "CW=";F;"GHz"
80 OUTPUT 719 ; "CW";F;"GZ"
90 GOTO 50
100 IMAGE "CW".00.000."GZ"
110 OUTPUT 719 USING 100 ; F
120 GOTO 50
```

PROGRAM 2 EXPLANATION:

- Line 10: Puts the 8350A into a predefined state via instrument preset.
- Line 20: Puts the 8350A in CW mode and programs a CW frequency of 7.555 GHz.
- Line 30: The 85A displays "CW = 7.555 GHz".
- Line 40: Temporarily stops program execution.
- Line 50: The 85A displays "CW (in GHz) = ?".
- Line 60: The user is prompted to input a new CW frequency value which is stored in the variable 'F'.
- Line 70: Print on the CRT display the programmed CW frequency.
- Line 80: Program the CW frequency using the default data format.

Line 90: Go to line 50.

Line 100: Image statement is set up for programming the CW frequency with a 1 MHz resolution.

Line 110: Program the CW frequency via image statement in line 100.

Line 120: Go to line 50.

The equipment setup is the same as the previous example. Reset the 85A, scratch the 85A memory, then type in the above program. Then perform the following:

1. Clear the 85A CRT display then run the program. The 85A displays "CW = 7.555 GHz". The 8350A changes from the instrument preset state of Start/Stop sweep to a CW frequency of 7.555 GHz.
2. Press **CONT** on the 85A. The 85A now displays "CW (in GHz) = ?". Type in a new CW frequency (value in GHz), then press **END LINE**.
3. The 8350A will be programmed to the new CW frequency with the new value printed on the internal printer. The program jumps back to step (2) above.

When inputting the CW frequency try several values, each with a different number of digits after the decimal point. Notice that the 8350A displays the frequency to 3 decimal places (1 MHz frequency resolution). Values with better than 1 MHz frequency resolution are rounded to the nearest MHz by the 8350A. However the 85A outputs data in a free-field format that outputs a number with all appropriate significant digits. Another approach is to utilize the image statement to set the desired number of decimal places. To use the image statement in the program, perform the following on the 85A:

Press **PAUSE SHIFT CLEAR**
Type 'DELETE 80, 90'
Press **END LINE**

This should delete lines 80 and 90 from program #2 and allow the use of lines 100, 110, and 120 instead. Run the modified program again and use the same steps for operation as before. Now if the value inputted has a frequency resolution greater than 1 MHz the 85A does the rounding instead of the 8350A. This is the preferred programming approach. Change the image statement for 10 MHz frequency

resolution and verify the results from the 8350A frequency display.

Since a device select code address can be a variable, verify that this can be used in the modified or original program #2 by doing the following:

1. Insert before line 10 a new line with the variable 'S' by:

Press PAUSE SHIFT CLEAR
 Type '5 S=719'
 Press END LINE

2. Modify the output statement(s) by editing the necessary lines and changing the 'OUTPUT 719' to 'OUTPUT S' and 'OUTPUT 719 USING 100' to 'OUTPUT S USING 100'.
3. Re-run the modified program using the same operation steps as above.

EXAMPLE PROGRAM 3: Setting Up A Typical Sweep

Typically the sweeper is programmed for the proper sweep frequency range, sweep time, power level, and marker frequencies for a test measurement. This program sets up the sweeper for a general purpose situation using several dedicated image statements. Note that not all parameters need to be reprogrammed every time.

NOTE

This program expects an 83500 Series Plug-in that covers the frequency range of at least 3 to 7 GHz. If using a plug-in with a different frequency range, change the values in lines 60, 90, and 100, to the appropriate values. If using an 86200 Series Plug-in then do not enter line 70.

```

PROGRAM 3
10 IMAGE "FA",DD DDD,"GZFB",DD
   DDD,"GZ"
20 IMAGE "ST",DDDDD,"MS"
30 IMAGE "M",D,DD DDD,"GZ"
40 IMAGE "PL",DDD DD,"DM"
50 OUTPUT 719 "IPMD1"
60 OUTPUT 719 USING 10 : 3.7
70 OUTPUT 719 USING 40 : 10
80 OUTPUT 719 USING 20 : 50
90 OUTPUT 719 USING 30 : 1.4
100 OUTPUT 719 USING 30 : 2.6
110 END
  
```

PROGRAM 3 EXPLANATION:

- Line 10: Image statement for setting the Start and Stop Sweep frequencies in GHz.
- Line 20: Image statement for setting the Sweep Time in milliseconds.
- Line 30: Image statement for setting a Frequency Marker by marker number and frequency in GHz.
- Line 40: Image statement for setting the Output Power Level in dBm.

- Line 50: Preset the sweeper to a known state via instrument preset and enable the internal 27.8 kHz Square Wave Amplitude Modulation.
- Line 60: Set a Start/Stop Sweep of 3.0 to 7.0 GHz.
- Line 70: Set the Output Power Level to +10 dBm.
- Line 80: Set the Sweep Time to 50 milliseconds.
- Line 90: Set Marker #1 to 4 GHz.
- Line 100: Set Marker #2 to 6 GHz.
- Line 110: Stop program execution.

Setup the equipment as shown in figure 2 by adding the 8755C, the 180TR or 182T, the 11664, and a test device like a 4 to 6 GHz Bandpass Filter. It is important that the two rear panel connections from the 8350A to the 8755C/182T are made for a proper CRT display. For the example measurement set the following front panel controls:

- On the 8755C:
 - Channel 1:
 - Display OFF (press all the display push buttons so that they are all out)
 - Channel 2:
 - Display B
 - dB/DIV 10 dB
 - Reference Level -10 dB
 - Reference Level Vernier OFF
- On the 182T or 180TR:
 - Magnifier X1
 - Display INT

After connecting the equipment: reset the 85A, scratch the 85A memory, then type in the above program. Clear the 85A CRT display then run the program. The 8350A will initially undergo an instrument preset which will set the proper power leveling mode and sweep blanking signals. Since the 8755C requires the RF signal to be modulated at a 27.8 kHz rate, the internal amplitude modulation is

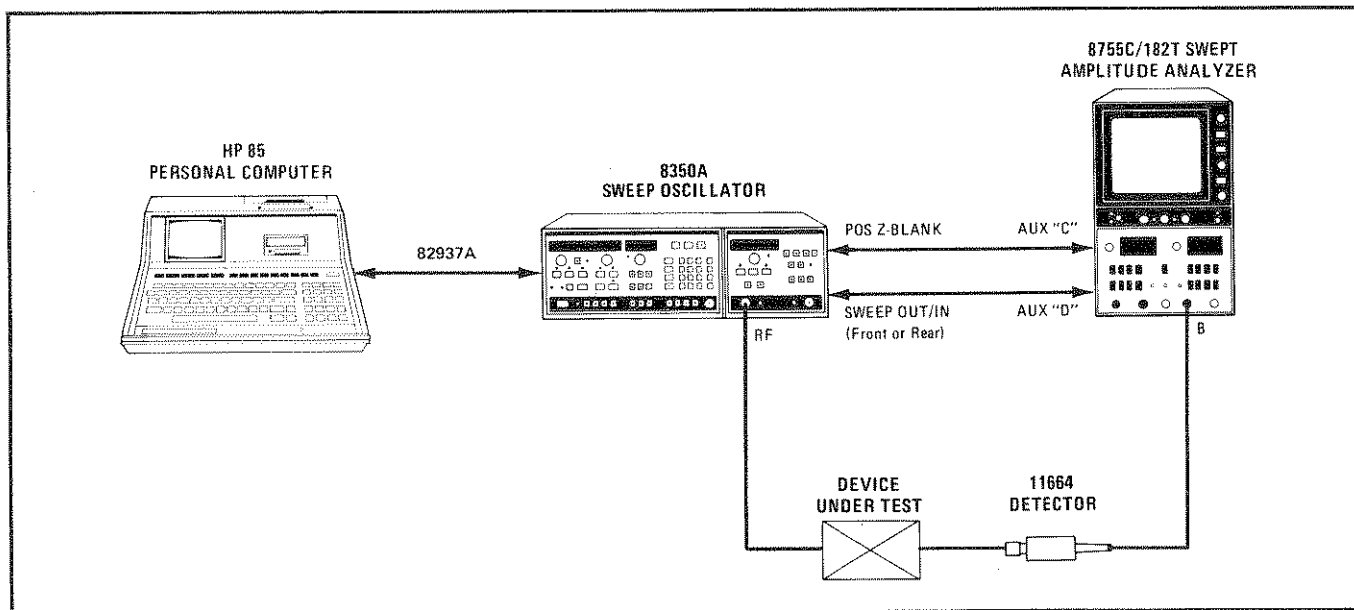

FIGURE 2: Equipment Setup For Program #3

enabled. If using a 4 to 6 GHz Bandpass Filter as the test device, the CRT display should reflect the filter transmission response over the 3 to 7 GHz range. Two frequency markers of the Z-Axis Intensity dot

variety are set to 4 and 6 GHz, hopefully within the passband or near the 3 dB points. The setup can be modified by changing the values in lines 60, 70, 80, 90, and/or 100, then re-run the program.

EXAMPLE PROGRAM 4: Learning An Instrument State

Being able to save a specific instrument state is helpful when it is needed several times in a test or measurement procedure. The user could save the instrument state by manually logging the important sweep parameters such as frequency range, power level, ALC modes, etc., then re-inputting them at the appropriate time. A somewhat simpler approach is to save the instrument state in one of the 8350A internal storage registers, then recall it when needed. However, this is not a permanent solution unless the 8350A Non-volatile Memory option (Option 001) is used. A more permanent solution is to use the Output Learn String function of the 8350A so that the 85A can learn then store a data string that describes the present instrument state on a tape cartridge or in its' internal memory. Once an instrument state is stored or learned, the 8350A can then be restored to that state using the Input Learn String function. The power of these instrument Learn/Teach functions are demonstrated by the following program using the 85A fast data transfer function.

```

PROGRAM 4
10 OPTION BASE 1
20 DIM A$(100)
30 I/O BUFFER A$
40 OUTPUT 719 ; "IPMD1"
50 LOCAL 719
60 PAUSE
70 OUTPUT 719 ; "OL"
80 TRANSFER 719 TO A$ FHS ; EDI
90 A$=A$[1..90]
100 PAUSE
110 OUTPUT 719 ; "IL"&A$
120 END

```

PROGRAM 4 EXPLANATION:

- Line 10: Define the first element of any array to be at index number 1.
- Line 20: Set the length of the A\$ string to 100 characters.
- Line 30: Set up the string A\$ as an I/O Buffer for data storage in fast read/write data transfer operations.
- Line 40: Set the 8350A to a predefined state via instrument preset and enable the square wave modulation.
- Line 50: Return the 8350A to local control.
- Line 60: Temporarily stop program execution.
- Line 70: Program the 8350A to output the Learn String.

Line 80: Read the Learn String into the 85A via the fast data transfer function using the HP-IB EOI (End or Identify) signal to terminate the transfer. Store the Learn String in A\$.

Line 90: Extract the Learn String information from the I/O Buffer by removing the buffer pointers. Re-save the Learn String only in A\$.

Line 100: Temporarily stop program execution.

Line 110: Program the 8350A to accept a Learn String, then send the new Learn String to the 8350A.

Line 120: Stop program execution.

Setup the equipment as in example 3 using the analyzers' CRT display to verify the sweep settings. Note that the original equipment setup can also be

used with the 8350A front panel indicators used for verification. Reset the 85A, scratch the 85A memory, then type in the above program. Clear the 85A CRT display then run the program. The 8350A will undergo an instrument preset, enable the square wave modulation, then return to local front panel control. Then perform the following:

1. Adjust the 8350A to a preferred instrument state, then press **CONT** on the 85A.
2. Turn the 8350A line power off. Wait five seconds then turn the 8350A power back on. Press **INSTR PRESET** on the 8350A.
3. Press **CONT** on the 85A. Verify on the analyzers' CRT display and/or the 8350A that the original instrument state has been restored.

EXAMPLE PROGRAM 5: Interrogating The Present Value Of A Function

While the 8350A Learn String enables the user to completely save a string of characters that define the present instrument state, the information is densely packed and encoded to save memory space. If the user wishes to determine the actual value of a specific parameter, say the Start Frequency, it would require a tedious process to extract a numeric value from several characters within the Learn String. An easier approach is to use the Output Interrogated Parameter function of the 8350A. With this function the 85A instructs the 8350A to output the present numeric value of a specified function. Any function that has a numeric value associated with it (except Step Size) can be interrogated. Note that if the parameter is not presently active, the 8350A uses a computed value or its previous value. The following program demonstrates the capability of the interrogate function.

```

PROGRAM 5
10 OUTPUT 719 ; "IPMD1"
20 LOCAL 719
30 PAUSE
40 OUTPUT 719 ; "OPFA"
50 ENTER 719 ; A
60 PRINT "Start Freq=" ; A / 100000
  ; "MHz"
70 OUTPUT 719 ; "OPFB"
80 ENTER 719 ; B
90 PRINT "Stop Freq=" ; B / 1000000
  ; "MHz"
100 OUTPUT 719 ; "OPST"
110 ENTER 719 ; T
120 PRINT "Sweep Time=" ; 1000 * T ;
  ; "msec"
130 END

```

PROGRAM 5 EXPLANATION:

- Line 10: Set the 8350A to a predefined instrument state via instrument preset and enable the square wave modulation.
- Line 20: Return the 8350A to local control.
- Line 30: Temporarily stops program execution.
- Line 40: Program the 8350A to output the present value of the Start Frequency.
- Line 50: Read the value into the 85A and store it in the variable 'A'.
- Line 60: Print on the internal printer the present value of the Start Frequency in MHz.
- Line 70: Program the 8350A to output the present value of the Stop Frequency.
- Line 80: Read the value into the 85A and store it in the variable 'B'.
- Line 90: Print on the internal printer the present value of the Stop Frequency in MHz.
- Line 100: Program the 8350A to output the present value of the Sweep Time.
- Line 110: Read the value into the 85A and store it in the variable 'T'.
- Line 120: Print on the internal printer the present value of the Sweep Time in milliseconds.
- Line 130: Stops program execution.

Setup the equipment as in example 3 using the analyzers' CRT display to verify the sweep settings. Note that the original equipment setup can also be used with the 8350A front panel indicators used for verification. Reset the 85A, scratch the 85A memory, then type in the above program. Clear the 85A CRT display then run the program. The 8350A will

undergo an instrument preset, enable the square wave modulation, then return to local front panel control. Then perform the following:

1. Adjust the 8350A to a preferred instrument state using the Start Frequency, Stop Frequency, and Sweep Time controls.

2. Press **CONT** on the 85A.
3. The present values of the Start Frequency, Stop Frequency, and Sweep Time are sequentially interrogated and then printed on the internal printer of the 85A.

EXAMPLE PROGRAM 6: A Stepped CW Sweep

Present automatic measurement systems typically make measurements at a sequence of CW test frequencies instead of analog sweeping the frequency range of interest. If swept, the measurement data taking machine would need to sample the RF signal at a very fast rate to maintain accurate frequency information, too. This is typically not accomplished. Stepped CW sweeps can be accomplished in several ways with the 8350A:

1. Program sequential CW test frequencies.
2. Program the frequency sweep range then enable the manual sweep mode. Perform a stepped manual sweep by repetitively programming the step up/increment function.
3. Program the CW frequency to the start frequency, the Step Size to an appropriate value, then repetitively program the step up/increment function.

Considering the speed of programming the above approaches, the third is the most efficient time wise. This program illustrates a stepped sweep using this approach.

PROGRAM 6	
10	OUTPUT 719 ; "IPMD1"
20	DISP "Start Freq (GHz) ="
30	INPUT A
40	DISP "Stop Freq (GHz) ="
50	INPUT B
60	DISP "Step Size (GHz) ="
70	INPUT C
80	D=(B-A)/C
90	OUTPUT 719 ; "CWSS",C;"GZ"
100	OUTPUT 719 ; "CW",A;"GZ"
110	FOR I=1 TO D
120	OUTPUT 719 ; "UP"
130	WAIT 20
140	NEXT I
150	GOTO 100

PROGRAM 6 EXPLANATION:

Line 10: Set the 8350A to a predefined instrument state and enable the square wave modulation.

Line 20: The 85A displays "Start Freq (GHz) = ?".

- Line 30: Input prompts for start frequency of the sweep. Store it in the variable 'A'.
- Line 40: The 85A displays "Stop Freq (GHz) = ?".
- Line 50: Input prompts for the stop frequency of the sweep. Store it in 'B'.
- Line 60: The 85A displays "Step Size (GHz) = ?".
- Line 70: Input prompts for the step size of the sweep. Store it in 'C'.
- Line 80: Determine the number of frequency steps in sweep, store in 'D'.
- Line 90: Set the CW Step Size.
- Line 100: Set the CW frequency to the start frequency value.
- Line 110: Iterate the CW step 'D' times.
- Line 120: Program the Step Increment/Up function.
- Line 130: Wait 20 milliseconds for settling.
- Line 140: Continue step iteration.
- Line 150: Go to line 100.

The equipment setup is the same as in the previous example. Reset the 85A, scratch the 85A memory, then type in the above program. Clear the 85A CRT display then run the program. The 8350A will undergo an instrument preset and enable the square wave modulation. Then perform the following:

1. The 85A will display "Start Freq (GHz) = ?". Answer this prompt by inputting the desired Start frequency (value in GHz) of the sweep, then press **END LINE**
2. The 85A will display "Stop Freq (GHz) = ?". Answer this prompt with the desired Stop frequency (in GHz) of the sweep, then press **END LINE**
3. The 85A will display "Step Size (GHz) = ?". Answer this prompt with the desired Step size (in GHz) of the sweep, then press **END LINE**
4. The 8350A CW frequency will be programmed to the Start frequency of the sweep selected. Then the CW frequency is repetitively incremented by the step size value. The sweep is then restarted after reaching the stop frequency.

To stop the program press **STOP**.

Since part of the time involved in changing CW frequencies is in updating the numeric LED display if this could be defeated the CW frequency time can be optimized. Note that one drawback is that the numeric display will not indicate the present frequency. The 8350A provides a Display Update On/Off function and it can be implemented by

modifying line 10 to be:

OUTPUT 719 ;"IPMD1DU0"

Then re-run the modified program using the same operation steps as above.

EXAMPLE PROGRAM 7: Using Service Requests, Status Bytes, and Request Mask

Certain error conditions of the 8350A can be detected by the 85A so that corrective action can be taken. Examples of some detectable error conditions are RF power unlevelled, numeric data entry out of range, and line power failure. If an error condition exists, the user can instruct the 8350A to request service from the 85A by initiating a Service Request (SRQ). The 85A can detect whether an SRQ has taken place on the bus by analyzing bit 7 (see note below) of the Status Byte of the 82937A HP-IB Interface. Two modes are available for analyzing the 82937A Status Byte: 1) periodically read the Status Byte, or 2) enable bit 7 to interrupt the program when it is set. In either case, once it is determined that the 8350A has requested service, the specific error condition(s) can then be determined by

reading and analyzing the Status Bytes of the 8350A. The 8350A has two Status Bytes, each consisting of 8 bits with each bit indicating the present status of a particular function or condition. See Figure 3 for a complete description of the conditions associated with each Status Byte bit. The user can analyze these Status Bytes for every SRQ, or more simply, instruct the 8350A to issue an SRQ only if a specific set of error conditions exists. The set of conditions is determined by a numeric value passed by the Request Mask function. This numeric value is generated by summing the decimal values of each Status Byte bit to be checked. This program demonstrates the capability of the SRQ and Status Bytes to detect an error condition.

TABLE 1: 8350A Status Byte Descriptions

STATUS BYTE (#1)								
BIT #	7	6	5	4	3	2	1	0
DECIMAL VALUE	128	64	32	16	8	4	2	1
FUNCTION	Front Panel SRQ REQUEST	REQUEST SERVICE (RQS)	SRQ on Syntax Error	SRQ on End of Sweep	*SRQ on RF Settled	SRQ on Change in Extended Status Byte	SRQ on Front Panel Entry Complete	SRQ on Numeric Parameter Altered to Default Value

EXTENDED STATUS BYTE (#2)								
BIT #	7	6	5	4	3	2	1	0
DECIMAL VALUE	128	64	32	16	8	4	2	1
FUNCTION	N/A	*RF Unlevelled	Power Failure	*RF Unlocked	*External Freq. Ref. Selected	*OvenCold	*Over Modulation	Self Test Failed

*Bit/Functions not usable with 86200 Series Plug-ins and 11869A Adapter.

NOTE

This assumes that the status bits are numbered 0 thru 7 with the least-significant bit being number 0. Other references may assume that the bits are numbered 1 thru 8 with the least-significant bit being number 1.

If using an 86200 Series Plug-in, the Status Bytes can provide only limited information. Table 1 indicates which Status Byte functions/bits are usable.

```
PROGRAM 7 †
10 ABORTIO ?
20 CLEAR 719
30 OUTPUT 719 ; "IPMD1"
40 ON INTR ? GOSUB 110
50 ENABLE INTR 7:8
60 DISP "CW Freq (GHz)=",
70 INPUT F
80 OUTPUT 719 ; "CW",F,"GZ"
90 WAIT 100
100 GOTO 60
110 STATUS 7,1 ; X
120 A=SPOLL(719)
130 IF BIT(A,0)=1 THEN PRINT "Pa
parameter Altered"
140 IF BIT(A,5)=1 THEN PRINT "Sv
ntax Error"
150 CLEAR 719
160 ENABLE INTR 7:8
170 RETURN
```

PROGRAM 7 EXPLANATION:

- Line 10: Clear the status of the HP-IB.
- Line 20: Clear the status of the 8350A.
- Line 30: Preset the 8350A to a predefined instrument state and enable the square wave modulation.
- Line 40: Indicate that if an interrupt from the 82937A HP-IB Interface is received that program execution will branch to the interrupt service routine located at the line 110.
- Line 50: Specify and enable the controller to accept an interrupt from the 82937A if bit 3 (decimal value 8) is set.

- Line 60: The 85A displays "CW Freq (GHz) = ?".
- Line 70: Input prompts for the desired CW frequency value in GHz. Store it in the variable 'F'.
- Line 80: Set the CW frequency as determined by 'F'.
- Line 90: Wait 100 milliseconds to allow the 8350A to interrupt.
- Line 100: Go to line 60.
- Line 110: Read the 82937A interrupt cause register to enable another interrupt.
- Line 120: Location of the interrupt service routine. Read the Status Byte of the 8350A and store it in 'A'.
- Line 130: Check bit 0 of the 8350A Status Byte for an Altered Parameter error. Print on the internal printer "Parameter Altered" if one exists.
- Line 140: Check bit 5 of the 8350A Status Byte for a Syntax Error. Print on the internal printer "Syntax Error" if one exists.
- Line 150: Clear the status of the 8350A.
- Line 160: Re-specify and re-enable bit 3 of the 82937A to cause an interrupt.
- Line 170: Return from the interrupt service routine to the main program.

The equipment setup is the same as the previous example. Reset the 85A, scratch the 85A memory, then type in the above program. Clear the 85A CRT display then run the program. The 8350A will undergo an instrument preset and enable the square wave modulation. The 85A then displays "CW Freq (GHz) = ?". Answer this prompt by inputting the desired CW frequency in GHz, then press **END LINE**. Verify that the 8350A CW frequency has been properly programmed. Try several values that are out of range of the plug-in's frequency limits and verify that an error message was printed on the internal printer. The program repeats the above input prompt. To stop the program press **PAUSE**.

† NOTE

For Program 7 to function properly change line 30 to: 30 OUTPUT 719; "IPMD1RM" & CHR\$(97). This change enables bit 5 (SRQ on Syntax Error) and bit 0 (SRQ on Numeric Parameter to Default Value).

HP-IB PROGRAM CODES

CODE	DESCRIPTION	CODE	DESCRIPTION
AKm	Amplitude Marker On/Off	MZ	MHz
ALmn	Alternate Sweep On/Off	M0	Marker Off
A1	Internal Leveling	M1	Marker #1
A2	External Crystal Leveling	M2	Marker #2
A3	External Power Meter Leveling	M3	Marker #3
BK	Backspace	M4	Marker #4
CAm	Amplitude Crystal Marker On/Off (83522/ 83525 Only)	M5	Marker #5
CF	Center Frequency	NT	Network Analyzer Trigger (8410B)
CI _m	Intensity Crystal Marker On/Off (83522/ 83525 Only)	OA	Output Active Parameter
CW	CW Frequency	OL	Output Learn String
C1	1 MHz Crystal Marker Frequency (83522/ 83525 Only)	OM	Output Mode String
C2	10 MHz Crystal Marker Frequency (83522/ 83525 Only)	OP	Output Interrogated Parameter
C3	50 MHz Crystal Marker Frequency (83522/ 83525 Only)	OS	Output Status Bytes
C4	External Crystal Marker Frequency (83522/ 83525 Only)	OX	Output Micro Learn String
DF	Delta F Frequency Span	PL	Power Level
DM	dBm	PS _m	Power Sweep On/Off
DN	Step Down/Decrement	RC _n	Recall Register
D _{Pm}	Display Blanking On/Off	RF _m	RF Power On/Off
D _{Um}	Display Update On/Off	RM	Service Request Mask
E	Exponent Power Of 10	RS	Reset Sweep
FA	Start Frequency	SC	Seconds
FB	Stop Frequency	SH	Shift Function
F _{Im}	CW Filter In/Out	SL _m	Slope On/Off
GZ	GHz	SM	Manual Sweep
HZ	Hz	SS	Step Size
IL	Input Learn String	ST	Sweep Time
IP	Instrument Preset	SV _n	Save Register
IX	Input Micro Learn String	SX	External Sweep
KZ	KHz	TS	Take Sweep
MC	Marker To Center Frequency	T1	Internal Sweep Trigger
MD _m	Square Wave Amplitude Modulation On/Off	T2	Line Sweep Trigger
MO	Marker Off	T3	External Sweep Trigger
MP _m	Marker 1-2 Sweep On/Off	T4	Single Sweep
MS	Milliseconds	UP	Step Up/Increment
		VR	CW Vernier
		0-9 + - Acceptable Numeric Data	

NOTES

1. Program codes of the form "XX_m" use "m" to turn the function On or Off (1 or 0). For the storage register functions the "n" is 1 through 9.
2. The 8350A ignores spaces, plus signs, negative signs (except for vernier, offset, and power values), and any unexpected characters. Program codes can be upper or lower case alpha characters.

For more information, call your local HP Sales Office or nearest Regional Office: Eastern (201) 265-5000; Midwestern (312) 255-9800; Southern (404) 955-1500; Western (213) 970-7500; Canadian (416) 678-9430. Ask the operator for instrument sales. Or write Hewlett-Packard, 1501 Page Mill Road, Palo Alto, CA 94304. In Europe: Hewlett-Packard S.A., 7, rue du Bois-du-Lan, P.O. Box, CH 1217 Meyrin 2, Geneva, Switzerland. In Japan: Yokogawa-Hewlett-Packard Ltd., 29-21, Takaido-Higashi 3-chome, Suginami-ku, Tokyo 168.

Quick Reference Guide for the HP 8350A Sweep Oscillator

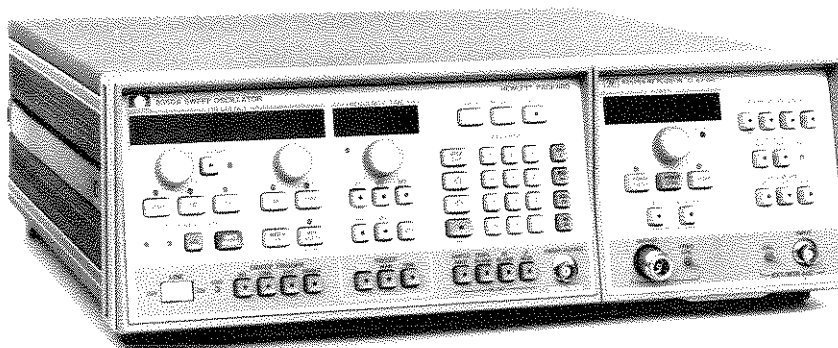

INTRODUCTION

This programming note is a reference guide for the remote operation of the HP 8350A Sweep Oscillator and HP 85300 Series Plug-ins. This note is intended for use by those familiar with HP-IB programming and the basic functions of the HP 8350A Sweep Oscillator. For complete programming information refer to the HP 8350A Operating and Service manual.

INPUT DATA

The 8350A Sweep Oscillator and 83500 Series Plug-ins accept programming codes that contain information for programming all of the front panel and special HP-IB only functions except the Line switch and Set HP-IB Address. The programming data string consists of a string of ASCII coded characters composed of one or more the following control fields:

- Sweep Mode/Limits
- Frequency Markers
- Sweep Trigger
- Modulation/Blanking

- Step Size
- Instrument State/Registers
- Power Level
- Power Control
- ALC Modes
- Crystal Markers (83522/83525 Plug-ins only)
- Special HP-IB Only Functions

Input Syntax. The 8350A responds to program codes in the order in which they are received. Each function is programmed with a string of ASCII coded characters that follow one of the following sequences.

- [Function Code] [Numeric Value] [Units terminator] [EOS]
- [Function Code] [Numeric Value] [EOS]
- [Function Code] [EOS]

NOTE

The HP-IB program code sequence typically mirrors that of the local front panel keystroke sequence.

Function Codes (Prefix Activate). Function codes are typically 2 to 4 character mnemonics. For functions that have a numeric value associated with it, passing the function code only will enable and activate the function for further data entry.

Numeric Value (Numeric Format). These are either a single decimal digit, a set of 14 characters or less representing a number, or a string of binary bytes. A string of 14 characters maximum can be expressed in exponential, decimal, or integer form. Acceptible numeric formats are referenced in further sections by the following format syntax:

Format #1: Exponential	$\pm d^{***}d.d^{***}dE\pm dd$
Format #2: Decimal	$\pm d^{***}d.d^{***}d$
Format #3: Integer	$\pm d^{***}d$
Format #4: Single Digit	d
Format #5: Binary String	b***b
Format #6: Binary Byte	b

Where the character 'd' indicates a leading or trailing zero, a space, or a numeric digit (0 through 9). The character 'b' indicates an 8-bit binary byte. The characters "****" indicate a variable number of the previous character. Numeric values that are not binary in nature are scaled by the appropriate units terminator.

Units Terminator (Suffix). These are 2 character codes that terminate and scale the associated numeric value. Frequency values can be entered in GHz, MHz, kHz, or Hz. Sweep time values can be entered in seconds or milliseconds. Power values can be entered in dBm or dB. If a units terminator is not passed and a Line Feed (LF), semicolon (;) or comma (,) is encountered, the 8350A assumes the numeric value is in the fundamental units of Hz, seconds, or dB.

End Of String Message (EOS). This can be the ASCII characters Line Feed (LF, decimal 10), semicolon (";", decimal 59), comma (";", decimal 44) the bus EOI line true, or another function code string.

Valid Characters. The alpha program codes can be either upper or lower case since the 8350A will accept either type (they can be interchanged). Spaces, unnecessary signs (+,-), leading zeroes, and carriage returns (CR) are ignored.

Programming Data. See Table 1 for Input Programming Codes.

NOTE

If using an 83500 Series Plug-in that has Option 002 (70 dB Step Attenuator), the lifetime of the Step Attenuator will be reduced if using the Alternate Sweep function that alternates between two power levels using different Step Attenuator settings. Likewise rapid power level programming between step attenuator settings can cause a similar problem.

Instrument Preset. Instrument Preset turns off all functions then sets the following:

Sweep Mode: Start/Stop
 Start = minimum specified frequency
 Stop = maximum specified frequency
 Sweep Type: Timed, minimum sweep time
 Sweep Trigger: Internal
 Vernier/Offset: set to 0 MHz
 Markers: all values set to center of frequency span, all off
 Modulation/Blanking: Display Blanking on
 Frequency Step Size: set to default value (10% of span)
 Status Bytes: cleared

83500 Series Plug-ins:
 Power Level: maximum specified power (switch selectable to minimum power)
 Power Sweep/Slope: set to 0 dB
 RF/CW Filter: on/enabled
 FM Sensitivity: determined by internal switch
 Power Step Size: set to default value (1 dB)
 Crystal Markers: 50 MHz, off

Instrument Preset does not affect Storage Registers, HP-IB address, or Service Request Mask value.

OUTPUT DATA

The 8350A has several output modes that allow the user to learn and interrogate the present instrument state. The following output modes are available:

- Learn String
- Micro Learn String
- Mode String
- Interrogated Function
- Active Function
- Status

The program codes and syntax to enable each function are described in the Input Data section. The Learn String, Micro Learn String, Mode String, and Status functions send a Data message consisting

Table 1. Input Programming Codes (1 of 4)

MODE	FUNCTION	PROGRAM CODE			NUMERIC VALUE			
		PREFIX ACTIVATE	NUMERIC FORMAT	SUFFIX	SCALE FACTOR	RANGE	RESOLUTION	
SWEEP LIMITS/MODE								
Start/Stop Sweep	START	FA	1,2,3,4	GZ	$\times 10^9$ Hz	Plug-in Frequency Limits	Approximately 0.03% of Plug-in Bandwidth	
	STOP	FB						
Center Frequency / Δ F Sweep	CF	CF		MZ	$\times 10^6$ Hz			
	Δ F	DF						
CW Frequency	CW	CW		KZ	$\times 10^3$ Hz			
	SWEPT CW	SHCW						
Frequency Offset	OFFSET	SHVR						
Frequency Vernier	VERNIER	VR	HZ	$\times 1$ Hz	$\pm 0.05\%$ of BW	0.0004% of BW		
FREQUENCY MARKERS								
Turn On and Set Marker Frequency	MARKER 1	M1	1,2,3,4	GZ	$\times 10^9$ Hz	Plug-in Frequency Limits	Approximately 0.4% of present Δ F	
	MARKER 2	M2			MZ			$\times 10^6$ Hz
	MARKER 3	M3			KZ			$\times 10^3$ Hz
	MARKER 4	M4						
	MARKER 5	M5			HZ			$\times 1$ Hz
Turn Off A Frequency Marker	M1 OFF	M1		M \emptyset				
	M2 OFF	M2						
	M3 OFF	M3						
	M4 OFF	M4						
	M5 OFF	M5						
Turn Off All Markers	ALL OFF	SHM \emptyset						
Turn On and Set Mkr Δ	MKR Δ , Marker "m", Marker "n"	SHM1	Mm Mn			where: m, n:1-5		
Turn Off Mkr Δ	MKR Δ OFF	M \emptyset						
Active Marker to Center Frequency	MKR \rightarrow CF	MC						
Marker 1-2 Sweep	MARKER SWEEP ON	MP1						
	MARKER SWEEP OFF	MP \emptyset						
Marker 1 to Start Marker 2 to Stop	M1 \rightarrow ST M2 \rightarrow SP	SHMP						
SWEEP TRIGGER TYPE								
Sweep Trigger Mode	INTERNAL	T1						
	LINE	T2						
	EXTERNAL	T3						
	SINGLE	T4						

Table 1. Input Programming Codes (2 of 4)





MODE	FUNCTION	PROGRAM CODE			NUMERIC VALUE		
		PREFIX ACTIVATE	NUMERIC FORMAT	SUFFIX	SCALE FACTOR	RANGE	RESOLUTION
SWEEP TRIGGER TYPE (Cont'd)							
Sweep Type	EXTERNAL SWEEP	SX					
	MANUAL SWEEP FREQUENCY	SM	1,2,3,4	GZ	$\times 10^9$ Hz	Present Start/Stop Frequency	0.1% of Present ΔF
				MZ	$\times 10^6$ Hz		
				KZ	$\times 10^3$ Hz		
				HZ	$\times 1$ Hz		
	SWEEP TIME	ST	1,2,3,4	SC	$\times 1$ sec.	See Plug-in Typically .01 to 100 sec.	0.001 sec.
MS				$\times 10^{-3}$ sec.			
MODULATION/BLANKING							
Amplitude Frequency Markers	AMPTD MKR ON	AK1					
	AMPTD MKR OFF	AK \emptyset					
Display Blanking	DISP BLANK ON	DP1					
	DISP BLANK OFF	DP \emptyset					
RF Blanking	RF BLANK ON	RP1					
	RF BLANK OFF	RP \emptyset					
Square Wave Modulation	 MOD ON	MD1					
	 MOD OFF	MD \emptyset					
STEP FUNCTIONS							
Setting Frequency Step Size	FREQUENCY STEP SIZE	SF	1,2,3,4	GZ	$\times 10^9$ Hz	\emptyset to 100% of Plug-in BW	Approximately 0.03% of Plug-in Bandwidth
				MZ	$\times 10^6$ Hz		
				KZ	$\times 10^3$ Hz		
				HZ	$\times 1$ Hz		
Setting Power Step Size*	POWER STEP SIZE	SP	1,2,3,4	DM	$\times 1$ dB	\emptyset to 15 dB	0.02 dB
Resetting Step Sizes To Default Values**	DEFAULT STEP SIZES	SHSS					
Increment Active Parameter	STEP UP 	UP					
Decrement Active Parameter	STEP DOWN 	DN					
INSTRUMENT STATE							
Instrument Preset	INSTR. PRESET	IP					
Saving An Instrument State	SAVE n	SV	4		$\times 1$	Registers 1 through 9	
Recalling An Instrument State	RECALL n	RC					
Alternate Sweep Mode	ALT n ON	AL1	4		$\times 1$	Registers 1 through 9	
	ALT n OFF	AL \emptyset					
Undergo Self Test	SELF TEST #nn	SH	3		$\times 1$	00-99	
*These codes/functions do not apply to 86200 Series Plug-ins. **Both frequency and power step size.							

Table 1. Input Programming Codes (3 of 4)

MODE	FUNCTION	PROGRAM CODE			NUMERIC VALUE		
		PREFIX ACTIVATE	NUMERIC FORMAT	SUFFIX	SCALE FACTOR	RANGE	RESOLUTION
SPECIAL HP-IB FUNCTIONS							
Status Bytes and Service Requests	OUTPUT STATUS	OS					
	SERVICE REQUEST MASK	RM	6			1 byte	
Full Learn String	OUTPUT LEARN STRING	OL					
	INPUT LEARN STRING	IL	5			90 bytes	
Micro Learn String***	OUTPUT MICRO LEARN STRING	OX					
	INPUT MICRO LEARN STRING†	IX	5			8 bytes	
Active Mode String	OUTPUT MODE STRING	OM	5			25 bytes	
Output Active Parameter Value	OUTPUT ACTIVE VALUE	OA					
Output Interrogated Parameter Value	OUTPUT INTERROGATED VALUE	OP		Interrogated Parameter Code			
Numeric Display Update	DISPLAY UPDATE ON	DU1					
	DISPLAY UPDATE OFF	DUØ					
Single Sweep Start/Stop	RESET SWEEP	RS					
	TAKE SWEEP	TS					
Network Analyzer Trigger (8410B)	NETWORK TRIGGER	NT					
PLUG-IN POWER LEVEL*							
Set Output Power Level	POWER LEVEL	PL	1,2,3,4	DM	×1 dBm	Plug-in Power Limits	0.02 dBm
Power Sweep Mode	POWER SWEEP ON	PS1	1,2,3,4	DM	×1 dB/Swp	Ø to 25.5 dB	0.02 dB
	POWER SWEEP OFF	PSØ					
Power Slope Mode	SLOPE ON	SL1	1,2,3,4	DM	× dB/GHz	Ø to 5 dB	0.01 dB
	SLOPE OFF	SLØ					
PLUG-IN ALC/SIGNAL CONTROL*							
ALC Leveling Modes	INTERNAL	A1					
	EXTERNAL (CRYSTAL)	A2					
	EXTERNAL POWER METER	A3					
RF Power	RF ON	RF 1					
	RF OFF	RF Ø					
CW Filter	FILTER ON	FI 1					
	FILTER OFF	FI Ø					
*These codes/functions do not apply to 86200 Series Plug-ins. ***Must be in CW mode, CW Filter off. †Exit this mode via "MØ" code.							

Table 1. Input Programming Codes (4 of 4)

MODE	FUNCTION	PROGRAM CODE			NUMERIC VALUE		
		PREFIX ACTIVATE	NUMERIC FORMAT	SUFFIX	SCALE FACTOR	RANGE	RESOLUTION
PLUG-IN CRYSTAL MARKERS*							
Crystal Marker Frequency	1 MHz	C1					
	10 MHz	C2					
	50 MHz	C3					
	EXTERNAL INPUT	C4					
Amplitude Markers	AMPL MKR ON	CA 1					
	AMPL MKR OFF	CA 0					
Intensity Markers	INTEN MKR ON	CI 1					
	INTEN MKR OFF	CI 0					
PLUG-IN SPECIAL FUNCTIONS*							
FM Input Sensitivity	-20 MHz/V	F1					
	-6 MHz/V	F2					
Peak Output Power ‡	PEAK	SHPL					
*These codes/functions do not apply to 86200 Series Plug-ins. ‡83590 Series Plug-in Only.							

of a string of 8-bit binary bytes terminated using the bus EOI line true with the last byte. The Interrogate and Active functions send a Data message consisting of a 14 character ASCII string representing the numeric value in exponential form terminated with a Carriage Return/Line Feed (CR/LF).

Binary Syntax: [b***b] [EOI]

Numeric Syntax: [±d.dddddE±dd] [CR] [LF]

Where the character 'b' indicates an 8-bit binary byte and 'd' indicates a decimal digit (0 through 9). Note that the binary output format could have bytes that may be misinterpreted as Carriage Returns and/or Line Feeds so the user should defeat the ASCII CR/LF as valid character string terminators and rely on the byte count.

Learn String:

Selected with the "OL" program code, the 8350A outputs a Learn String of 90 bytes in length. This binary data string completely describes the present instrument state (does not include the Storage Registers) of the 8350A and 83500 Series Plug-in. The information is packed and encoded for minimal storage requirements thereby making data analysis difficult. When stored in an ASCII character data

string, the Learn String can later be input to the 8350A to restore that instrument state (See Input Data for Input Learn String information). The length of the Learn String is fixed, independent of the functions selected and the plug-in used.

Format: 90 [8 bit bytes] [EOI]

Micro Learn String:

Selected with the "OX" program code, the 8350A outputs a Micro Learn String of 8 bytes in length. This binary data string completely describes the present CW frequency, Vernier, Sweep Output voltage, and Power Level of the 8350A and 83500 Series Plug-in. The information is packed and encoded for minimal storage requirements thereby making data analysis difficult. When stored in an ASCII character data string, the Micro Learn String can later be input to the 8350A to restore that instrument state for rapid frequency programming (See Input Data for Input Micro Learn String information). Note the 8350A must be in CW mode and the CW Filter should be off when using this function. The length of the Micro Learn String is fixed, independent of the functions selected and the plug-in used.

Format: 8 [8 bit bytes] [EOI]

Mode String:

Selected with the "OM" program code, the 8350A outputs a Mode String of 25 bytes in length. This binary data string describes all presently active functions of the 8350A and 83500 Series Plug-in. The information is not packed thereby making data analysis simpler. The information passed includes only the active functions with no numeric values included. Use the Active or Interrogate Function if numeric values are desired. The length of the Mode String is fixed, independent of the functions selected and the plug-in used.

Format: 25 [8 bit bytes] [EOI]

Interrogate Function:

Selected with the "OP" program code and the program code for the function to be interrogated, the 8350A will output the present numeric value of the selected function. The units of the output data are Hz, dBm, dB, or sec., implied with the function selected.

Format: [\pm d.dddde \pm dd] [CR] [LF]

Active Function:

Selected with the "OA" program code, the 8350A will output the present numeric value of the presently active function (ie. enabled for modification from the keyboard or step keys). The units of the output data are Hz, dBm, dB, or sec., implied with the function selected.

Format: [\pm d.dddde \pm dd] [CR] [LF]

Status:

Selected with the "OS" program code, the 8350A will output 2 sequential bytes, 8 bits wide, giving the present instrument status. The first status byte is equivalent to the Status Byte of the Serial Poll, the second status byte is the Extended Status Byte which provides additional information. See Table 2 for a description of each Status Byte. Status Byte values are cleared upon execution of a Serial Poll (Status Byte message), Device Clear message, and/or the Instrument Preset function.

TRIGGER

The 8350A responds to the Group Execute Trigger (GET) command to the HP-IB bus select code and a Selective Device Trigger to the 8350A HP-IB address.

The effect of the GET command is to trigger the sweep if presently in the Single Sweep Trigger mode only, otherwise no action is taken. The response is as if a Data message consisting of the Single Sweep Trigger (T4) program code were transmitted.

CLEAR

The 8350A responds to both Device Clear (DCL) and Selective Device Clear (SDC) messages by clearing the Status Byte and the Extended Status Byte.

REMOTE/LOCAL CHANGES

The Local to Remote change is programmed by the Selective Device Remote Enable message (REN and 8350A address). The 8350A instrument state is unchanged with all future changes affected by program codes only. Note that all front panel functions are disabled in Remote except the LCL key.

The Remote to Local change is programmed by the Go To Local (GTL) command or by setting the REN line false (high). The 8350A instrument state is unchanged with all future changes affected by the front panel controls. The 8350A can also be set to Local by pressing the LCL key. Note that the 8350A does not respond to the LCL key if the Local Lockout command has been executed. This command disables all front panel functions including the LCL key.

SERVICE REQUEST

The 8350A can initiate a Service Request (SRQ) whenever one of the following conditions exist:

- Error in syntax
- Parameter value modified to default value
- Hardware failure
- End of sweep

Further information can be obtained by conducting a Serial Poll or by executing the Output Status command, both of which access Status Byte information. The SRQ is cleared only by executing a Serial Poll. To select an SRQ for a particular set of circumstances, the Request Mask function can be used to select which of the bits in the first Status Byte can cause an SRQ. The mask value is determined by summing the decimal values of each selected function/condition that is desired. The default Request Mask at power on is '00000000' or decimal 0. This mask value is reset to the default value only at power on.

STATUS BYTE

The 8350A responds to a Serial Poll by sending its status byte as indicated in Table 2. A second status byte is available but must be accessed via the Output Status command. When Bit 6 (Request Service) of the Status Byte is true (one), an SRQ has occurred. See Service Request for the conditions causing a Service Request. Bit 4 indicates whether a change has occurred in the Extended Status Byte. If Bit 4 is true, then the second status byte should be accessed via the Output Status function to determine the cause of the status change. All other bits indicate the present status of the noted function. The bits are true (one) if and only if the associated function/condition is true.

STATUS BIT

The 8350A does not respond to a Parallel Poll.

PASS CONTROL

The 8350A does not have the ability to take or pass control.

ABORT

The 8350A responds to the Abort message (Interface Clear — IFC true) by stopping all Listener or Talker functions.

ADDRESS ASSIGNMENT INFORMATION

The 8350A has a primary address that is determined by an internal storage register. The register is initialized upon power turn on by reading the address bits A5 thru A1 from switches located on the 8350A A8 HP-IB Assembly. Note that these switches are factory preset to decimal 19. The 8350A HP-IB address can be dynamically changed from the front panel in local mode by executing the "Set HP-IB Address" command (Shift Local). See the 8350A Operating and Service Manual for further information.

Table 2. 8350A Status Byte Descriptions

STATUS BYTE (#1)								
BIT #	7	6	5	4	3	2	1	0
DECIMAL VALUE	128	64	32	16	8	4	2	1
FUNCTION	N/A	REQUEST SERVICE (RQS)	SRQ on Syntax Error	SRQ on End of Sweep	N/A	SRQ on Change in Extended Status Byte	N/A	SRQ on Numeric Parameter Altered to Default Value

EXTENDED STATUS BYTE (#2)								
BIT #	7	6	5	4	3	2	1	0
DECIMAL VALUE	128	64	32	16	8	4	2	1
FUNCTION	Airflow Failure	*RF Unleveled	Power Failure/on	N/A	N/A	N/A	N/A	Self Test Failed

*Bit/Functions not usable with 86200 Series Plug-ins and 11869A Adapter.

For more information, call your local HP Sales Office or nearest Regional Office: **Eastern** (201) 265-5000; **Midwestern** (312) 255-9800; **Southern** (404) 955-1500; **Western** (213) 970-7500; **Canadian** (416) 678-9430. Ask the operator for instrument sales. Or write Hewlett-Packard, 1501 Page Mill Road, Palo Alto, CA 94304. In Europe: Hewlett-Packard S.A., 7, rue du Bois-du-Lan, P.O. Box, CH 1217 Meyrin 2, Geneva, Switzerland. In Japan: Yokogawa-Hewlett-Packard Ltd., 29-21, Takaido-Higashi 3-chome, Suginami-ku, Tokyo 168.

